

R4131 SERIES SPECTRUM ANALYZER

INSTRUCTION MANUAL

OPERATIONS

ADVANTEST®
ADVANTEST CORPORATION

1
2
3
4
5
6
7
8
9
10
11
12
13
14
15
16
17
18
19
20
21
22
23
24
25
26
27
28
29
30
31
32
33
34
35
36
37
38
39
40
41
42
43
44
45
46
47
48
49
50
51
52
53
54
55
56
57
58
59
60
61
62
63
64
65
66
67
68
69
70
71
72
73
74
75
76
77
78
79
80
81
82
83
84
85
86
87
88
89
90
91
92
93
94
95
96
97
98
99
100

R4131 SERIES SPECTRUM ANALYZER

INSTRUCTION MANUAL

MANUAL NUMBER EM00 9504(A)

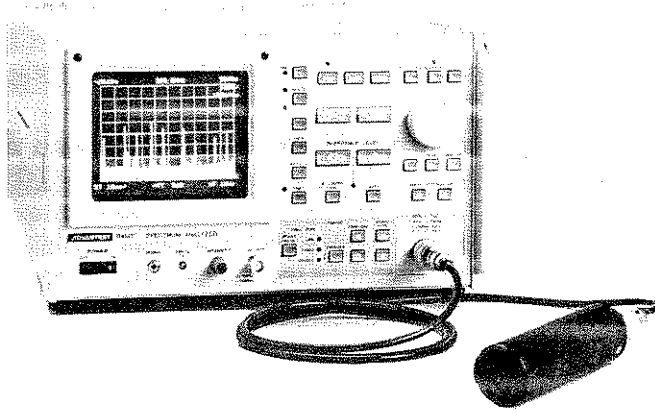

Applicable Instruments

R4131C

R4131CN

R4131D

R4131DN

ADVANTEST

The product is a Strategic Commodity subject to
COCOM regulations.

It should not be exported without the proper
authorization from Japanese government.

ADVANTEST CORPORATION

©1988 ADVANTEST CORPORATION
All rights reserved

First printing February 17, 1988
Printed in Japan

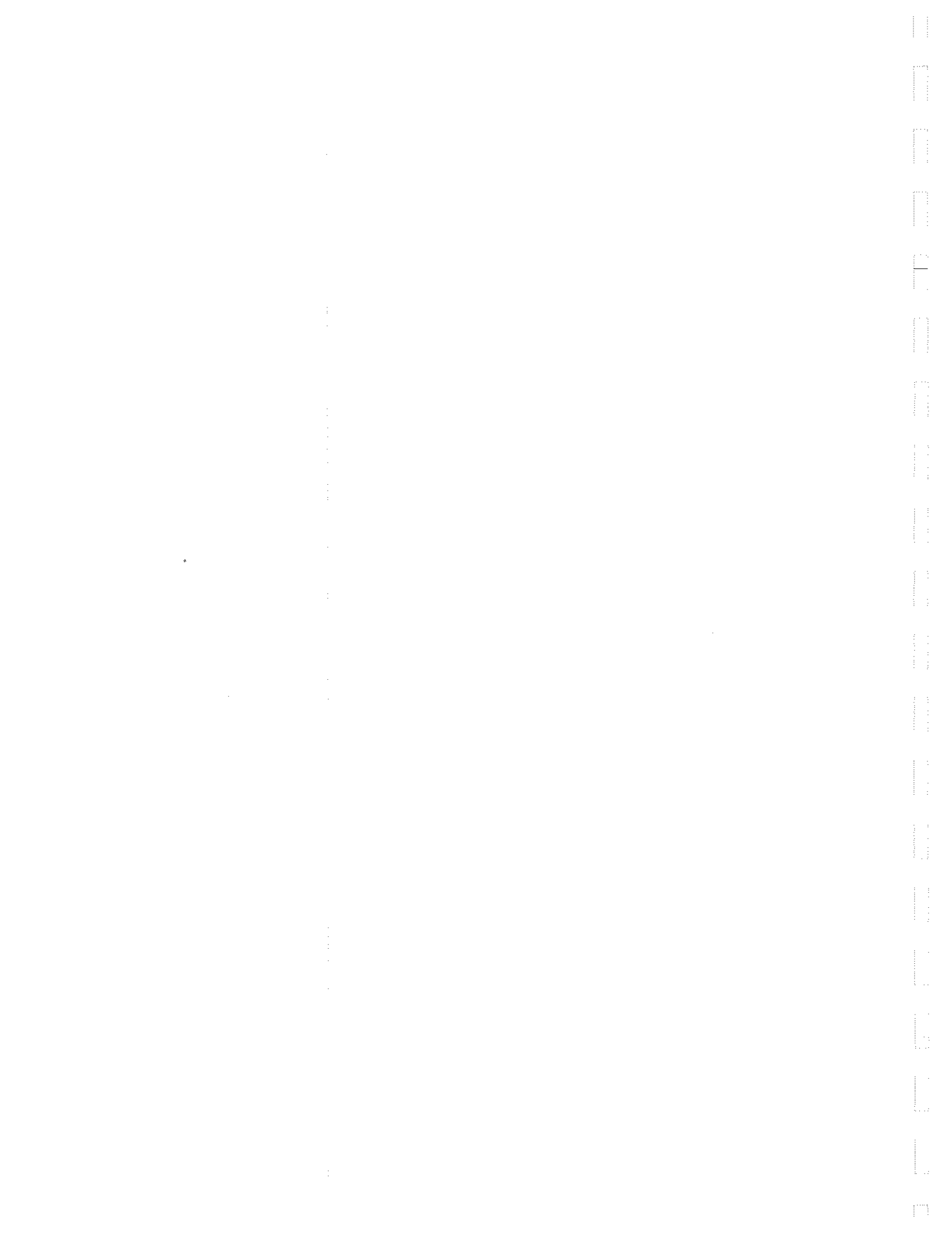

1. GENERAL DESCRIPTION

Information and notes necessary to use this instrument for Operating Manual safety are written. Read before this instrument is used.

1.1 How to Use this Operation Manual

This manual proceeds from basic knowledge to application so that anyone can master the abundant functions of this equipment even when using such an intelligent spectrum analyzer for the first time. Those who are accustomed to using an intelligent spectrum analyzer can start the measurement at once merely by referring to [Chapter 4. OPERATING PROCEDURE]. The functional description of each key is given in [Chapter 3. DESCRIPTION OF PANEL SURFACE LAYOUT AND DISPLAY].

1.2 Outline of Products

The R4131 covers a band-width as wide as 10 kHz to 3500 kHz and is controlled by a microcomputer. This analyzer features easy confirmation of all measuring conditions, since its frequency span is 4 GHz to 50 kHz, resolution is 1 MHz to 1 kHz, level data resolution by a marker is 0.05 dB, tube surface dynamic range is 80 dB, and the setting conditions of the its major functions are shown on its CRT display.

The panel of this equipment enables its three major functions (center frequency, frequency span, and reference level) to be independent of each other, and its layout makes for excellent operability. In addition, the resolution band, sweep time and input attenuator values are set automatically by its AUTO feature.

Table 1-1 lists the other major functions of R4131.

Table 1-1 Major Function of R4131

Major function*	R4131C	R4131D	R4131CN	R4131DN
Input impedance	50 Ω		75 Ω	
Accuracy in frequency display	±10 MHz	*100 kHz	±10 MHz	*±100 kHz
QP value automatic operation	Standard mounting			
Antenna factor automatic operation				
GPIB control				
Copy	Direct plotting with a plotter			
SAVE/RECALL function	Storing three setting conditions in its non-volatile memory.			
	Storing three display waveforms in its non-volatile memory.			
	Possible to set automatically at power ON.			
Displaying function	WRITE and VIEW Screen display			
	POSI PEAK display	POST/NEG display	POSI PEAK display	POSI/NEG display
Occupied band-width	--	Standard Configuration	-----	

Note: *Where frequency ≤ 2.5 GHz after zero calibration

1.3 Before Starting the Use

1.3.1 Appearance Check and Accessory Check

After R4131 was received, first check flaws or damage in appearance that could have occurred during its transportation.

Next, check the standard accessories for their quantity and standards, referring to Table 1-2 for R4131C/D and to Table 1-3 for R4131CN/DN. If any flaw, damage, shortage in accessories, etc., is found, contact the nearest dealer or the sales and support offices.

Table 1-2 R4131C/D Standard Accessories

No.	Name	Specification	Stock No.	Q'ty	Remarks
1	Fuse	218005	DFT-AA5A	2	
2	Allen wrench	3 mm	--	1	
3	Input cable	MI-02	DCB-FF0386	1	
4	NC-BNC adapter	JUG-201A-U	JCF-AF001EX03	1	
5	Power cable	A01402	DCB-DD2428X01	1	
6	Instruction manual	--	JR4131	1	Japanese
		--	ER4131		English

Table 1-3 R4131CN/DN Standard Accessories

No.	Name	Specification	Stock No.	Q'ty	Remarks
1	Fuse	218005	DFT-AA5A	2	
2	Allen wrench	3 mm	--	1	
3	Input cable	D3S015(Black)	DCB-FF2928X01	1	
4	NC-BNC adapter	BA-A165	JCF-AF001EX04	1	
5	C15 adapter	NCP-NFJ	JCF-AF001EX06	1*	*R4131DN only
6	Power cable	A01402	DCB-DD2428X01	1	
7	Instruction manual	--	JR4131	1	Japanese
		--	ER4131		English

1.3.2 Environmental Conditions for Use

- ① Refrain from using this equipment in a place subject to much vibration direct sunlight, and where corrosive gas is generated.
The unit is designed for indoor use.
Also, do not use it where the ambient temperature is outside 0°C to 50°C and relative humidity is less than 85%.
It may occasionally be subjected to temperatures between 0°C and -10°C without degradation of its safety.
- ② Since this equipment employs a suction type cooling fan to prevent the internal temperature from rising, install this equipment 10 cm or more from the wall, and do not place anything close to its back nor use this equipment in an incorrect position.
- ③ Although the equipment design for noise from the AC power supply line, use it allows where there is low noise as far as possible, and use a noise filter for noisy places.
- ④ The storage temperature range for this equipment is -20°C to +70°C. When this equipment is not used for a long period of time, store it in a dry place away from direct sunlight, covered with vinyl or placed in a cardboard box.

1.3.3 Before turning This Analyzer on

WARNING

1. Before any other connection is made, make sure this instrument has been properly grounded through the protective conductor of the AC power cable to a socket outlet provided with protective earth contact. Any interruption of the protective (grounding) conductor, inside or outside the instrument, or disconnection of the protective earth terminal can result in personal injury.
2. Before turning this analyzer on, make sure that it is set to the voltage of the power supply (Refer to Table 1-4.).
3. If the fuse rating is not as specified, this unit may be broken.

(1) Power Supply Condition

The power supply conditions of R4131 are given in Table 1-4.

Table 1-4 Power Supply Conditions

Power supply	Condition
Input voltage	90 V to 132 V or 198 V to 250 V rmp
Frequency	48 to 66 Hz
Power consumption	Less than 120 VA

CAUTION

When the power supply does not conform the conditions given in Table 1-4, this equipment could break down.

(2) Check for Fuse

The fuse of the power supply AC line is T5 A/250 V for either 90 V to 132 V or 198 V to 250 V in input voltage.

Check the fuse set in the power connector of the rear panel as shown in Figure 1-1.

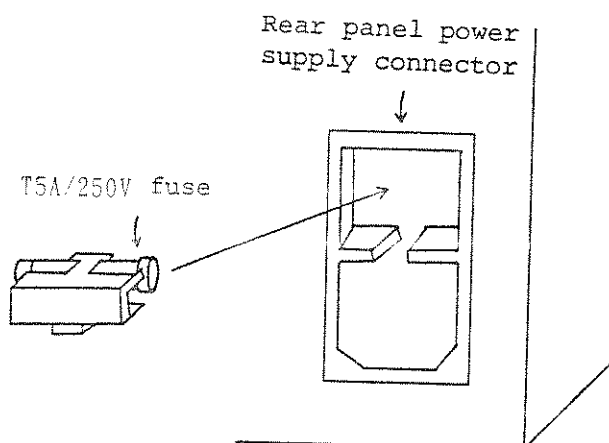

Figure 1-1 Check for Fuse

CAUTION

When used with a fuse not in the specified value, this equipment could break down.

(3) Check for Power Supply Cable

Turn OFF the POWER switch on the front panel of this equipment. Next, connect the attached power supply cable to the AC LINE connector. The plug is a 3-pin type and the round pin in the middle is the earth.

When using the R4131C, R4131CN, R4131D, R4131DN defend the following.

- Connect power plug with the outlet prepared the protective earth terminal.
- Do not use extension cable without a protective conductor.

When a 2-pin adaptor is used, be sure to connect either the ground wire led from the adaptor or the ground terminal located on the rear panel to the ground.

WARNING.

Any interruption of the protective conductor inside or outside the R4131C, R4131CN, R4131D, R4131DN or disconnection of the protective earth terminal is likely to make the instrument dangerous. Intentional interruption is prohibited.

2. USING R4131 FOR THE FIRST TIME

This chapter describes the fundamentals of operating R4131 for those using for the first time.

Note: Before turning ON the power for this equipment, read through Section 1.3, Before Use.

2.1 Screen of Spectrum Analyzer

Figure 2-1 shows the screen of R4131, indicating the relationship among the center frequency, span width, and reference level.

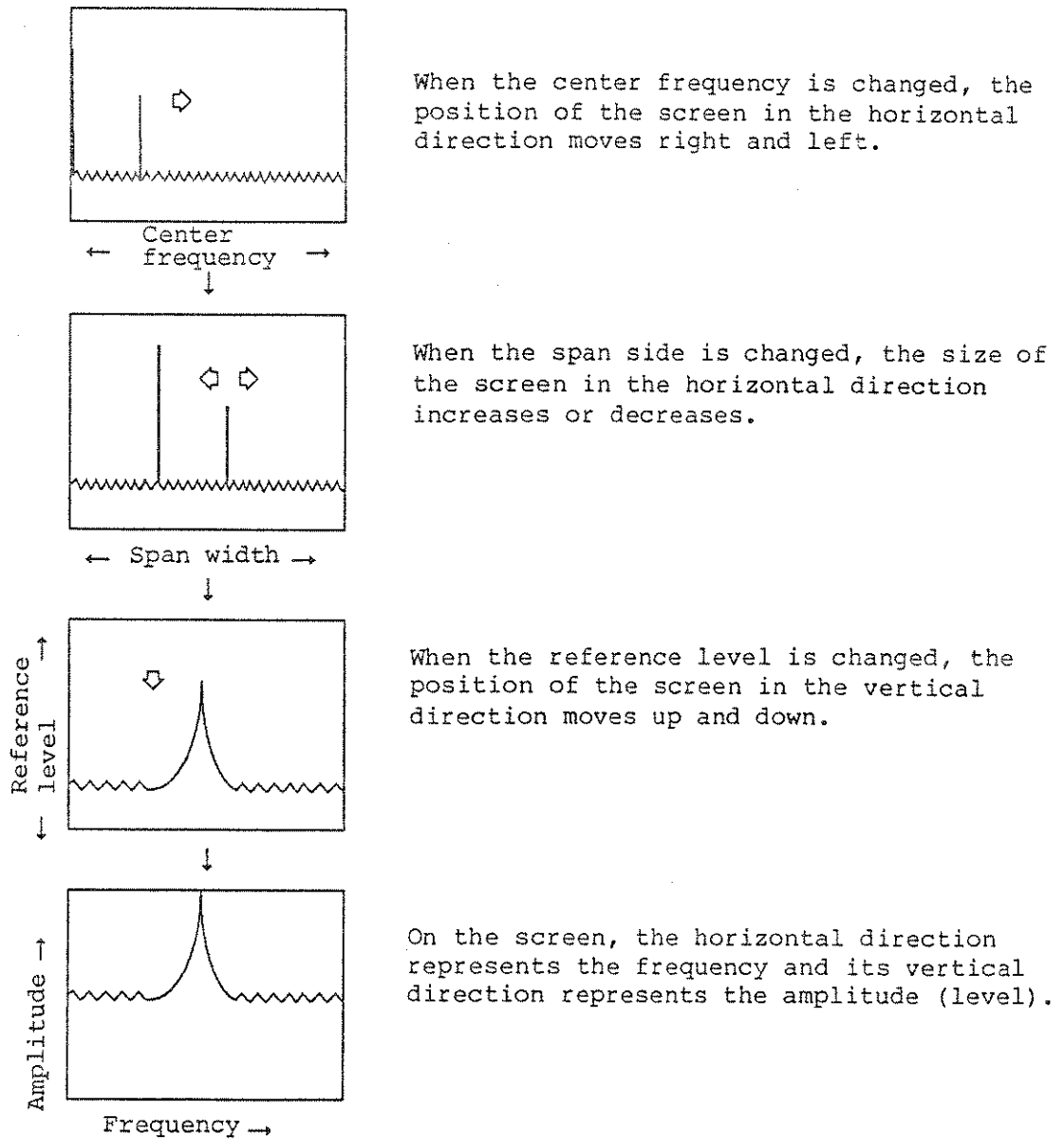

Figure 2-1 Screen of Spectrum Analyzer

2.2 Basic Operating Procedure

While operating actually using the calibration signal of this equipment, learn how to use the most important keys.

(1) Initialization Screen

First, turn ON the power.

When the power ON automatic setting function is in operation or a key

is pressed after the power ON, press the ^{SHIFT} and ^{OFF} keys to initialize the screen as shown Figure 2-2.

Note: See Section 4.17, Power ON Automatic Setting.

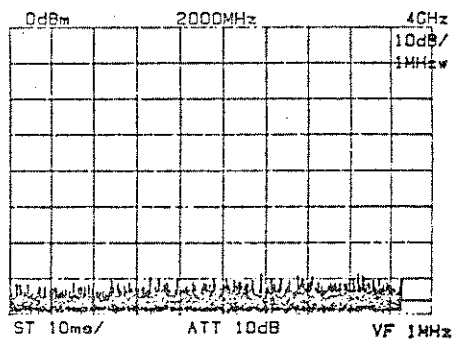

Figure 2-2 Initialization screen

(2) Input of Measurement Signal

Referring to Figure 2-3, input the calibration signal of this equipment to the terminal INPUT.

Calibration signal

R4131C/D Frequency: 200 MHz \pm 30 kHz
 Level : -30 dBm \pm 0.5 dB

R4131CN/DN Frequency: 200 MHz \pm 30 kHz
 Level : 80 dB μ \pm 0.5 dB

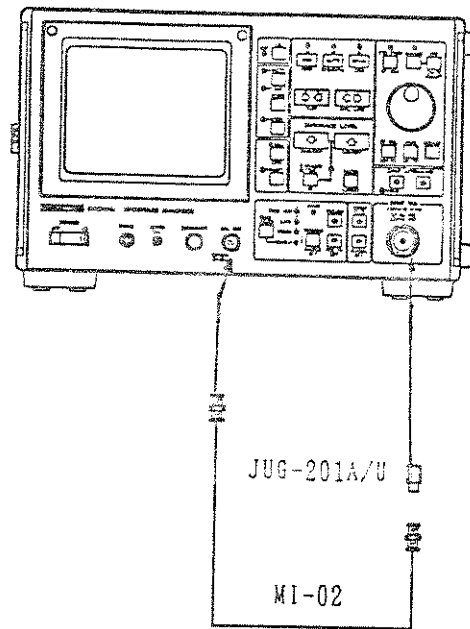
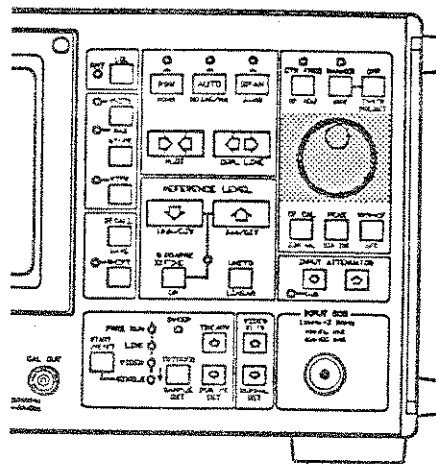

Figure 2-3 Input the Calibration Signal

(3) Setting of Center Frequency

Since the calibration signal is already known to be 200 MHz in frequency and -30 dBm in output, set the center frequency to 200 MHz. Turn the data knob counterclockwise to set the spectrum of the input signal to the center of the CRT.



Data knob

Turn the data knob, then the waveform moves in the horizontal direction (Figure 2-4).

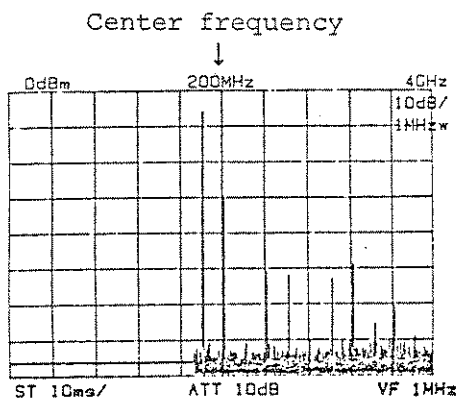
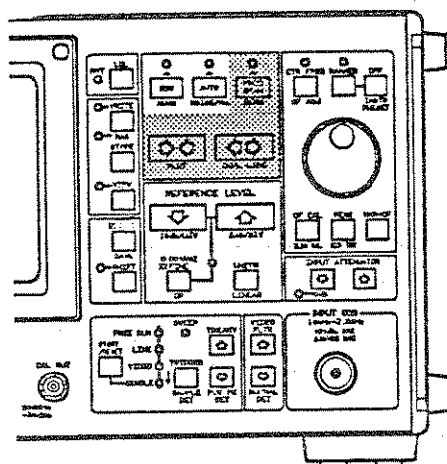



Figure 2-4 Setting Center Frequency to 200 MHz

(4) Setting of Frequency Span

Since the frequency span of this equipment is set very wide to 4 GHz on initialization, change it to 2 MHz.



Press the  key, then the frequency span becomes narrower in steps of 1-2-5 (Figure 2-5).

If the spectrum deviates from the center in this case, turn the data knob to change the center frequency and make it narrower while seizing the spectrum in the center.

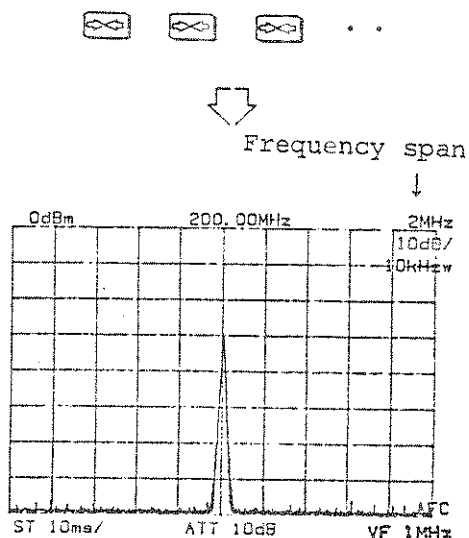

Figure 2-5 Setting the Frequency Span to 2 MHz

Since the **RTD** is selected at initialization in the resolution bandwidth, it is set to the maximum value automatically according to the setting condition of the frequency span.

(5) Setting of Reference Level

The reference level of this equipment -- the horizontal line on the top of the screen grid -- is set to 0 dB at initialization. Change it to -30 dB and set the spectrum of the calibration signal to the reference level.

REFERENCE LEVEL

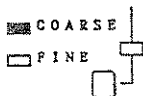

When the REFERENCE LEVEL key is pressed, the reference level goes up and down in steps of 10 dB. It is set to 10 dB/DIV at initialization.

When the COARSE or FINE key is pressed and FINE is selected, the LED on the upper right of this key lights and the mode is set to FINE.

The 10DB/DIV or 2DB/DIV key is used to change the set value in 1-dB steps.

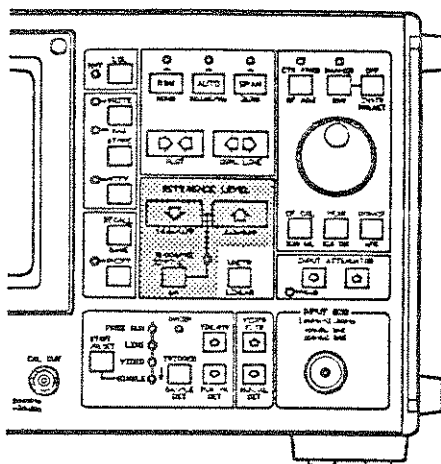

REFERENCE LEVEL key
and FINE STEP key



Reference level

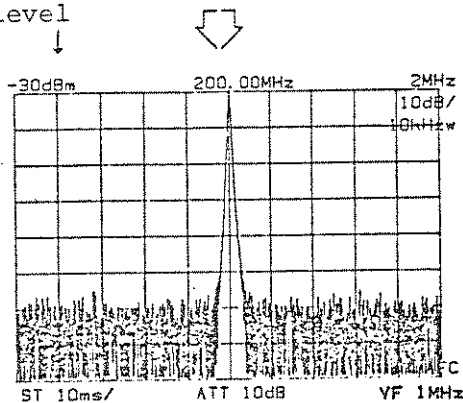

Figure 2-6 Setting the Reference Level to -30 dB

(6) How to Use the MARKER Key

By using the MARKER, you can read the frequency directly at the displayed marker point and level data.

The following is a description of this procedure:

MARKER

When the key is pressed, the LED on its upper lights and the marker (◇) appears on the center frequency axis.

Move the marker with the data knob to set the marker to the measured signal (Figure 2-7). The data of the signal can be read directly according to the marker frequency and its level.

When the marker is cleared, press the key.

- PEAK search

PEAK

When the key is pressed, the marker moves to the maximum level waveform displayed.

- Marker → Center Frequency

MKR → CF

When the key is pressed, the marker frequency becomes the center frequency and the marker returns to the center.

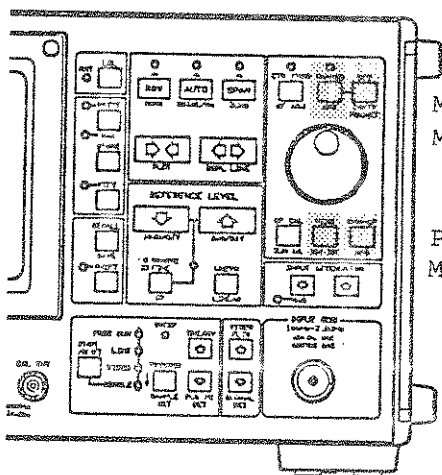

MARKER Key and
MARKER OFF key

PEAK key and
MKR → CF key

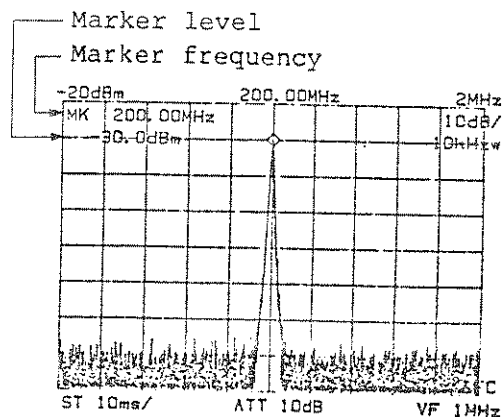

Figure 2-7 Setting the Marker to the Peak of the Measured Signal

(7) How to Improve Frequency Accuracy According to the Correction Routine

When the ^{SHIFT} , ZERO CAL key is pressed, the frequency correction routine, ZERO CAL, is executed. (Then, the "ZERO CAL" is displayed on the bottom right of the CRT.) When the ZERO CAL is executed before measurement starts, the center frequency accuracy is improved as shown below:

R4131C/CN	Center frequency accuracy	0 to 3.5 GHz	: ±10MHz
R4131D/DN	Center frequency accuracy	0 to 2.5 GHz	: ±100kHz
		2.5 GHz to 3.5 GHz:	±10MHz

(8) Warm-up Time

To use this equipment at the specified accuracy, take 30 minutes or more for its warm-up.

MEMO 

3. DESCRIPTION OF PANEL SURFACE AND CRT DISPLAY

This chapter describes each section on the panel and display screen of this equipment.



3.1 Description of Front Panel

Figure 3-1 shows the front panel.

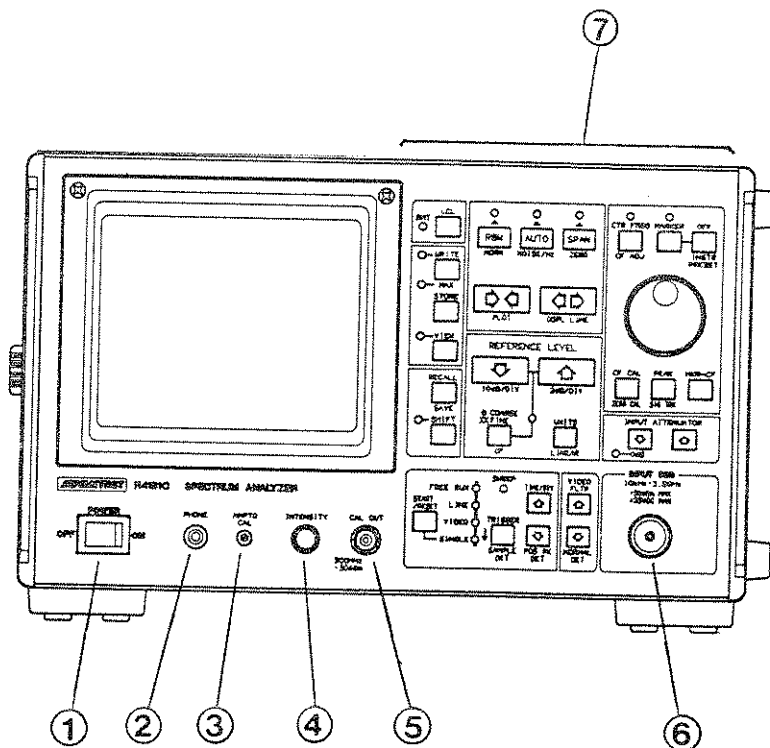

Figure 3-1 Description of Front Panel

1 Power ON/OFF Switch

The waveform is displayed at power ON and after a self-test (self-diagnosis).

2 Earphone Jack

This is a jack used for an 8-ohm earphone, to monitor the received modulated wave with the earphone (TR16191) when this equipment is used as a fixed tuning receiver.

3 Variable Resistor for Correcting Level Display

This is a variable resistor to correct the level display of this equipment.

④ Variable Resistor for Adjusting Brightness

This is a variable resistor to correct the brightness of the CRT display.

⑤ Output Connector of Correction Signal

For R4131C/D

Outputs the signal of 200 MHz and -30 dB.

For R4131CN/DN

Outputs the signal of 200 MHz and 80 dB.

CAL OUT



200MHz
-30dBm

CAL OUT



200MHz
80dB μ

⑥ Input Connector

For R4131C/D

The maximum input level is +20 dBm and ± 25 VDC max. when the input attenuator is more than 20 dB.

INPUT 50 Ω

10kHz-3.5GHz

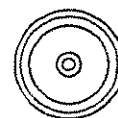

+20dBm MAX
 ± 25 VDC MAX

For R4131CN/DN

The maximum input level is +127 dB μ and ± 25 VDC max. when the input attenuator is more than 20 dB.

INPUT 75 Ω

10kHz-3.5GHz

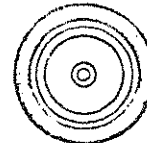

127dB μ MAX
 ± 25 VDC MAX

CAUTION

Note that the 75 Ω input connector is vulnerable when using R4131CN/DN. Unless the 75 Ω NC-BNC type is used for the BNC adaptor, the input connector breaks down very easily.

⑦ Analyzer Control Key

Three basic keys of the spectrum analyzer -- center frequency, span width, and amplitude level -- and this equipment are separated into three sections to be independent of each other for excellent operability.



The center frequency can be set with the data knob

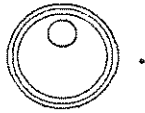

The frequency span width can be set with the



This key can set the reference level.

Also, pressing the SHIFT key sets the SHIFT mode and executes the function whose name is inscribed in blue immediately below the next key you press.

3.2 Description of Each Key (in the NORMAL mode)

3.2 Description of Each Key (in the NORMAL mode)

The function of each key is the NORMAL mode is as described in Figure 3-2.

Automatically sets resolution band width (RBW), sweep time and VIDEO FILTER band width according to the frequency span. (Indicated with LED.)

Selects the resolution band width setting mode. (Indicated with LED.)

Selects the FREQUENCY SPAN SET mode. (Indicated with LED.)

LOCAL mode setting: Interrupts the external control to enable the key input. (Indicated with LED in the REMOTE mode.)

Selects the CENTER FREQUENCY SET mode. (Indicated with LED.)

Sets the frequency span and RBW.

Rewrites the displayed waveform for each sweeping. (Indicated with LED.)

Displays the marker. (Indicated with LED.)

Makes the waveform stand still and stores it.

Erases the marker. (Indicated with LED.)

Displays the stored waveform. (Indicated with LED.)

Sets the data knob: center frequency and the marker frequency.

Puts the analyzer into the RECALL mode and displays the memory select screen.

Clears the tuning error of the internal tuning transmitter.

Sets the SHIFT mode. (Indicated with LED.)

Sets the marker frequency to the center frequency.

Repeats the START or RESET in the SINGLE TRIGGER mode.

Moves the marker to the highest level peak on the screen.

Sets the input attenuator.

Sets the reference level.

Changes the reference level step.

Selects the level unit.

Selects the TRIGGER mode. (The selected trigger mode is indicated with the LED.)

Sets the sweep time. Sets the VIDEO FILTER band width.

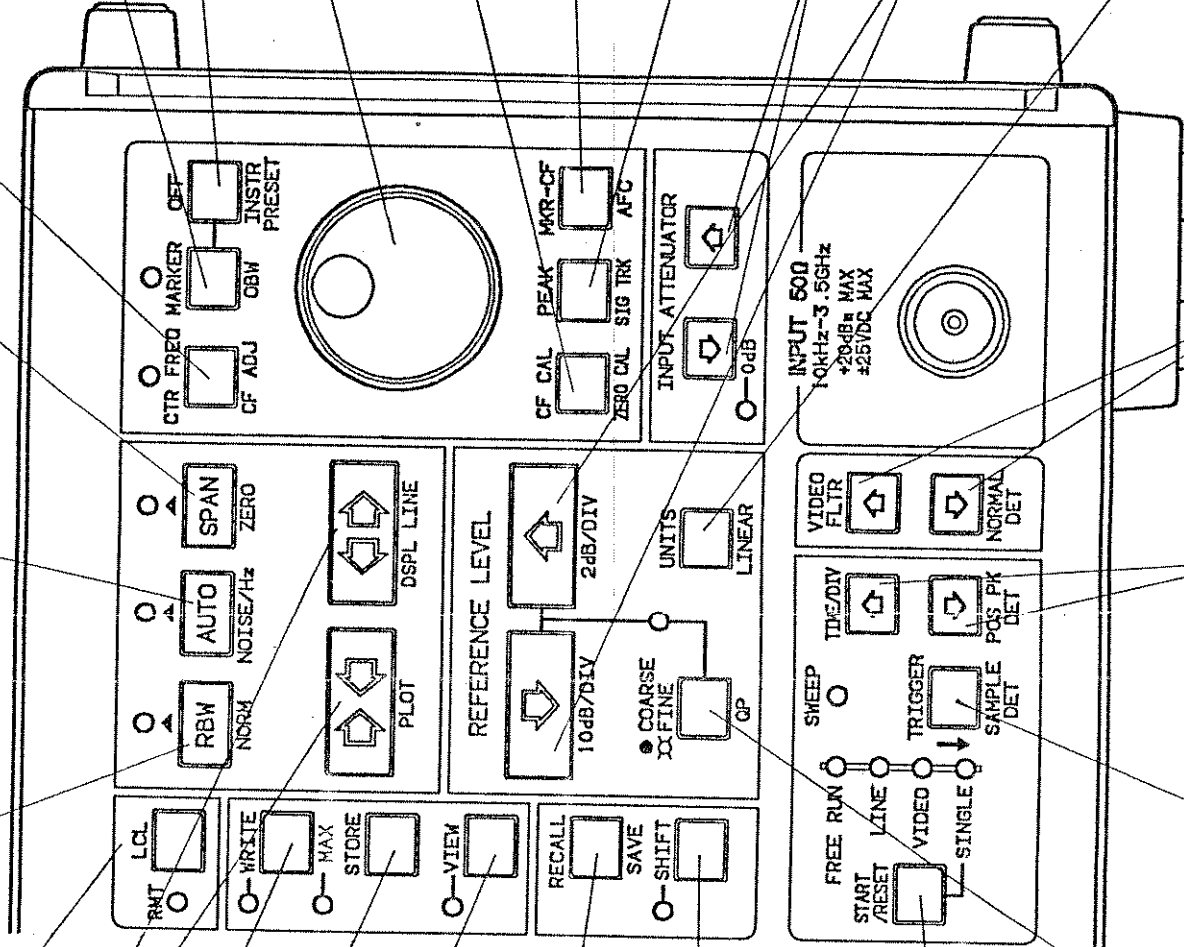
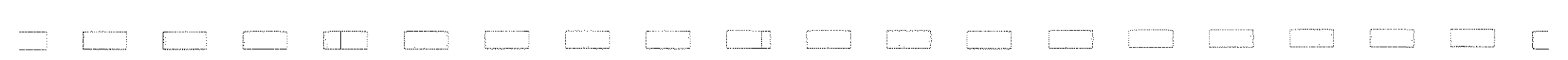

Figure 3-2 Description of Each Key in the NORMAL Mode



3.3 Description of Each Key
(in the SHIFT mode)

3.3 Description of Each Key (in the SHIFT mode)

The function of each key in the SHIFT mode is as described in Figure 3-3.

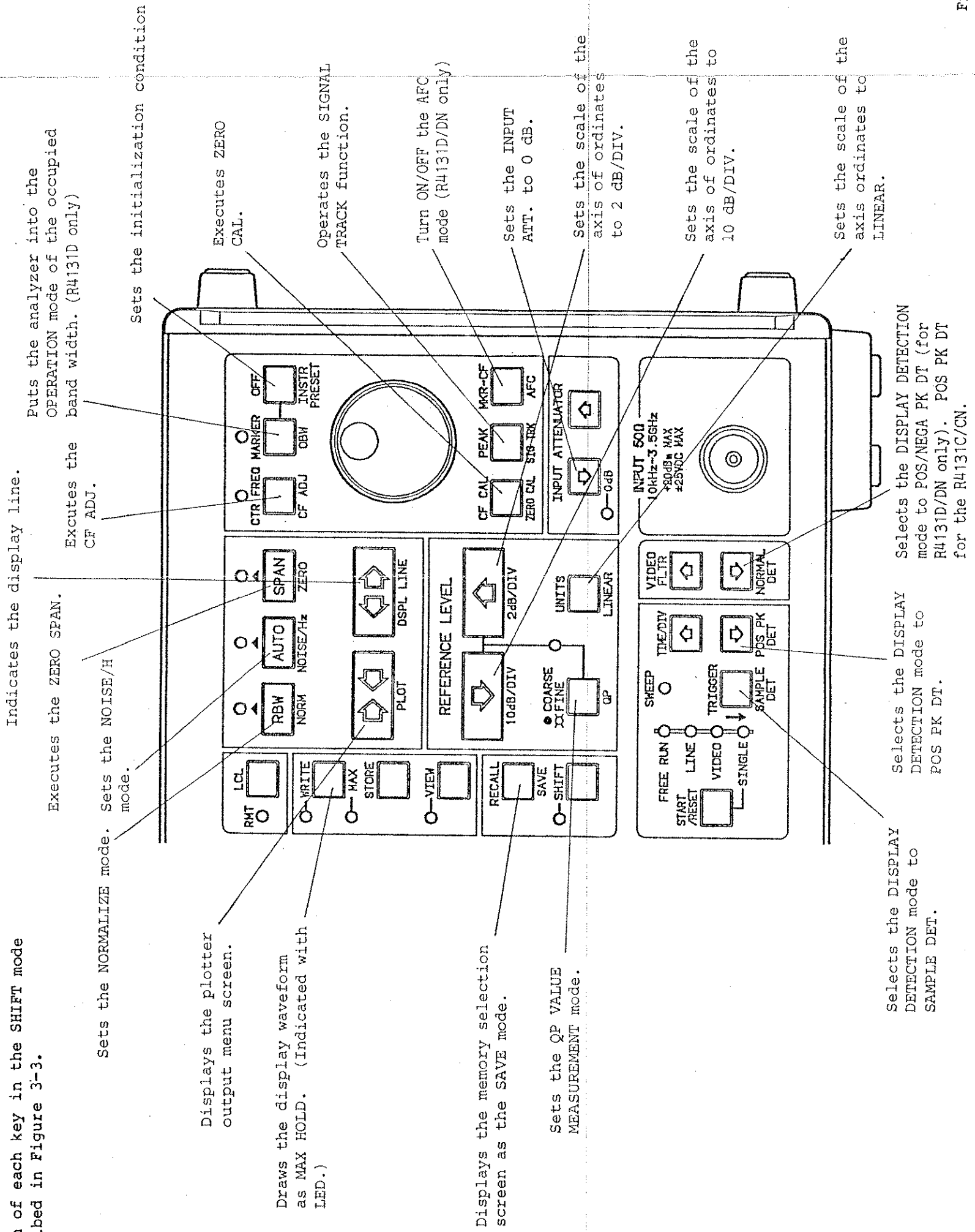
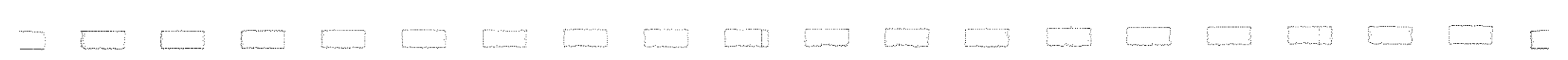

Figure 3-3 Description of Each Key
in the SHIFT Mode
3 - 6 May 31/94



3.4 Description of Rear Panel

The rear panel is as described in Figure 3-4.

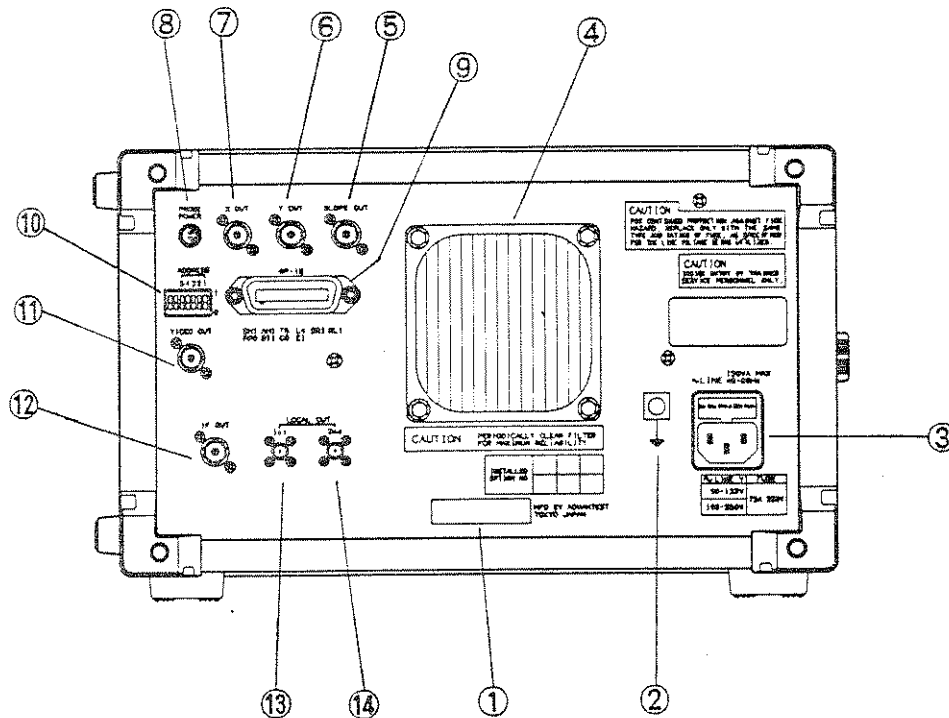

Figure 3-4 Rear Panel

① Serial No.

A serial No. of this equipment is printed.

Japan only

② Ground terminal

Used to connect the unit frame to the ground when neither 3-pin nor 2-pin power cable connector cannot be used.

③ Connector for AC Power Cable

This connector is a 3-pin type, and the center pin is a terminal for grounding.

When the upper lid is drawn out, the power fuse can be taken out.

④ Cooling Fan

This is a suction type cooling fan.

⑤ Connector for Slope Correction

This connector is used to output the slope correcting voltage 2 V/GHz for the tracking generator.

⑥ Output Connector to XY Recorder of WRITE Waveform

Y. OUT ... approx. 0 to 4 V, and output impedance approx. 220 Ω

⑦ Output Connector to XY Recorder of WRITE Waveform

X. OUT ... approx. -5 V to +5 V, and output impedance approx. 10 K Ω

⑧ Connector for Probe Power

This is the power supply for accessories, e.g., active probe, etc.

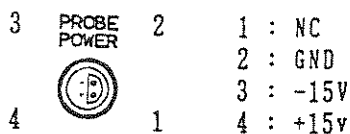

⑨ GPIB Connector

This is a terminal used when this equipment is connected to an external controller or plotter with the GPIB cable.

⑩ Address Switch for GPIB

The GPIB address is set using 1- to 5-digit switches.

⑪ Output Connector to External CRT Display and VIDEO Plotter, etc.

Output impedance ... approx. 75 Ω and 1 V_{p-p}, including the composite signal.

⑫ Output Connector for IF Monitor

This terminal is used to supply IF output 3.58 MHz and approx. 50 Ω . The output level can be set according to the input attenuator and reference level.

⑬ LOCAL OUT Connector for Tracking Generator

1st LOCAL OUT ... more than -5 dBm at 4 GHz to 7.5 GHz

⑭ LOCAL OUT Connector for Tracking Generator

2nd LOCAL COUT ... more than -5 dBm at 3.77 GHz.

CAUTION

When connector ⑬ and ⑭ for the tracking generator is used while opened, accurate measurement can not be occasionally done. Connect with the tracking generator or if you do not use the connector, install attached terminal instrument.

3.5 How to Read CRT Display Indication

3.5 How to Read CRT Display Indication

Various setting conditions are displayed on the screen. Their indication and the contents of each indication are shown in Figure 3-5.

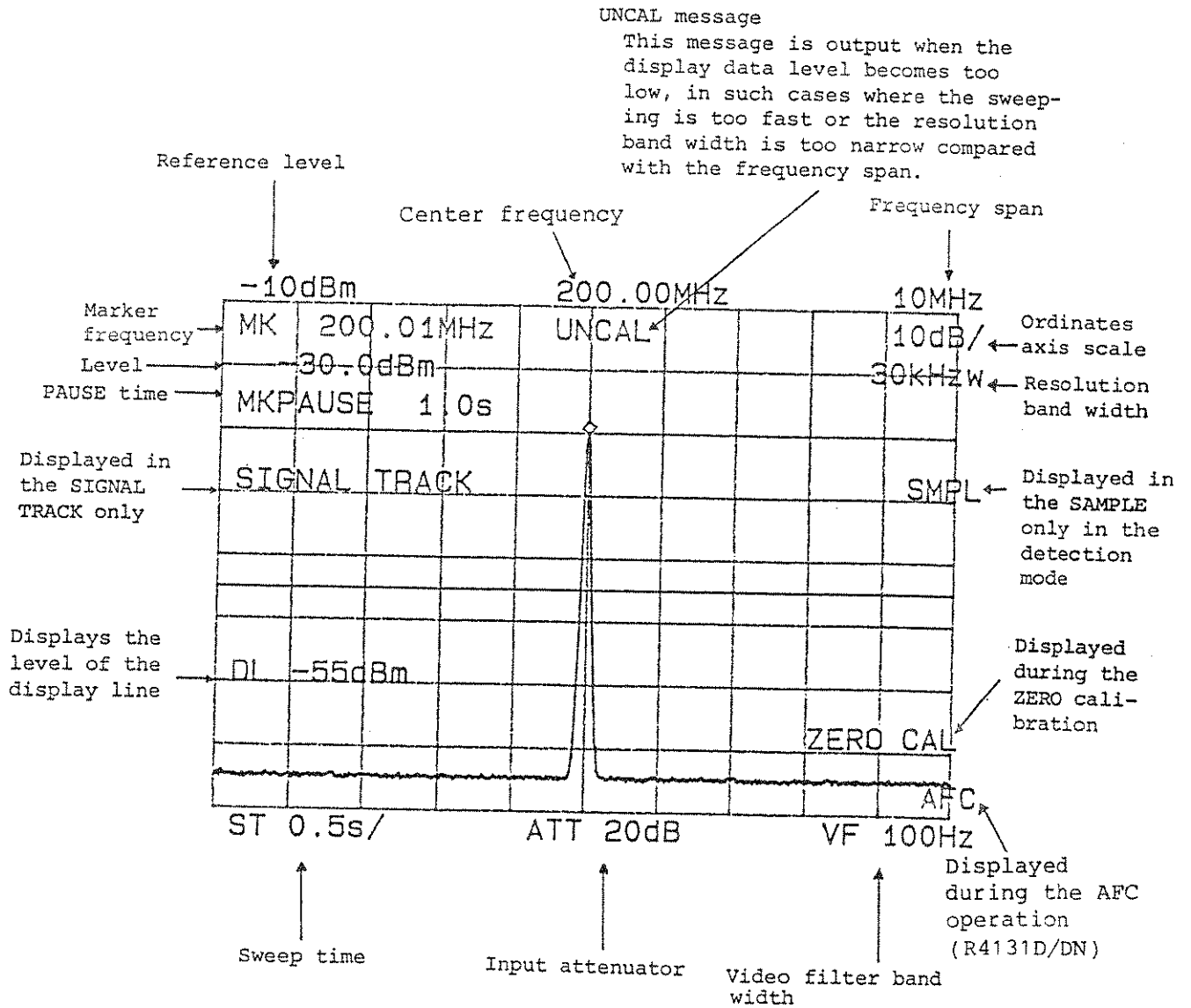

Figure 3-5 Indication of CRT Display

R4131 SERIES
SPECTRUM ANALYZER
INSTRUCTION MANUAL

4. Operating Method

4. OPERATING METHOD

This chapter describes the basic operating method of this equipment with same measuring examples included.



4.1 Initialization

When the ^{SHIFT}, ^{INTER}
_{PRESET} key is pressed, the equipment is set to the initial values as shown in Table 4-1.

Table 4-1 Initialization Condition

Set item	Initialization condition
Center frequency	2000 MHz
Frequency span	4 GHz
Reference level	0 dBm (:R4131C/D)
	110 dBu (:R4131CN/DN)
Resolution band width	1 MHz
VIDEO FLTR band width	1 MHz
SWEEP TIME	10 mS
INPUT ATT.	10 dB
TRIGGER MODE	FREE RUN
Marker	OFF
Ordinates axis scale	10 dB/DIV
DETECTION MODE	POSI-NEGA PEAK (:R4131D/DN)
	POSI PEAK (:R4131C/CN)
TRACE MODE	WRITE

4.1 Initialization

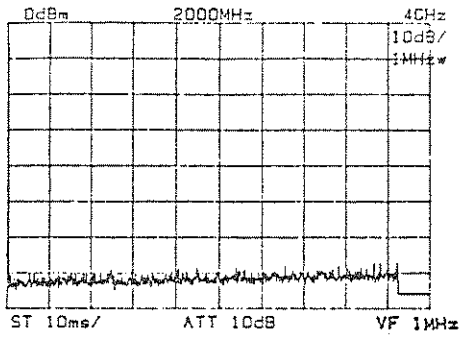

(a) R4131C

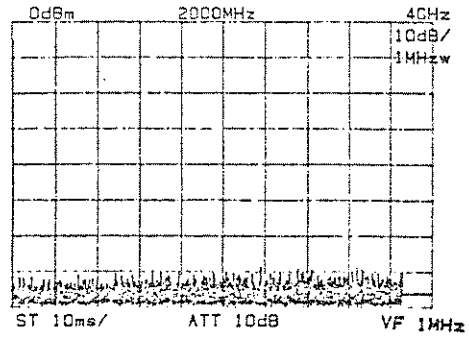

(B) R4131D

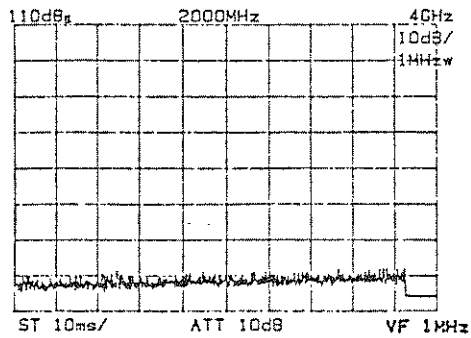

(c) R4131CN

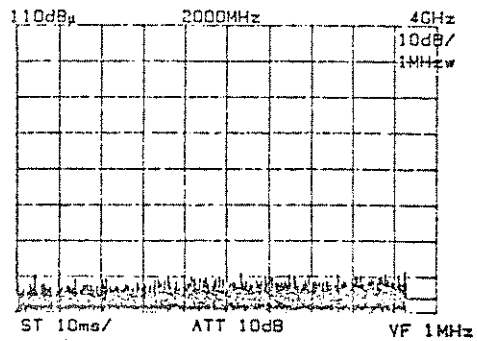

(d) R4131DN

Figure 4-1 Initial Screen

4.2 Center Frequency

The equipment is set to the CTR FREQ CHANGE mode at the initialization of the data knob. However, when it is set to the MARKER CHANGE mode, press the key. Then the LED on the key lights and the equipment is set to the CTR FREQ SET mode.

When the data knob is turned, the center frequency changes in a range from 0 MHz to 3620 MHz.

The set resolution is 1/200 of the frequency span.

Center Frequency Accuracy

The center frequency accuracy becomes the following range after the execution of the ZERO CAL in the local feed through (zero waveform):

R4131C/CN	0 Hz to 3.5 GHz :	±10 MHz or less
R4131D/DN	0 Hz to 2.5 GHz :	±100 kHz or less
	2.5 GHz to 3.5 GHz :	±10 MHz or less

Display of center frequency

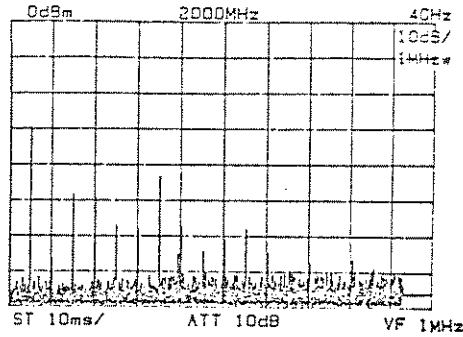

CTR FREQ



Data knob

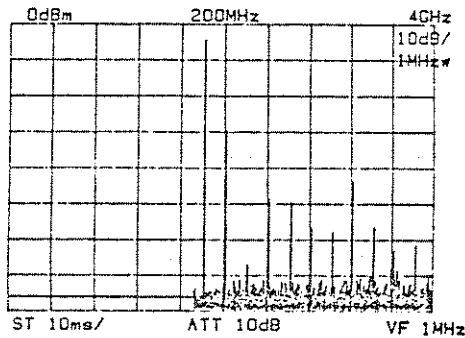

Figure 4-2 Change in Center Frequency

4.3 Function to Improve Center Frequency Accuracy

(1) AFC Function (only in R4131D/DN)

Since the AFC circuit is mounted in R4131D/DN, the AFC turns ON from when the frequency span becomes lower than 200 MHz and displayed as AFC on the bottom right of the screen. Consequently, the center frequency accuracy becomes ± 100 kHz or less after the execution of the ZERO CAL, described later. (It is confined to the case where the center frequency is 0 Hz to 2.5 MHz, however.)

To use this equipment with this AFC function kept OFF, key in the ^{SHIFT} and _{AFC} keys. (When the AFC is turned OFF, the tracking time is shortened and the total sweep time becomes shorter.)

To use the equipment with the AFC kept ON again, press the ^{SHIFT} and _{AFC} keys, then the AFC circuit starts operating.

(2) ZERO CALibration

Press the ^{SHIFT} and _{ZERO CAL} keys, then ZERO CAL is executed. ("ZERO CAL" is then indicated on the bottom right of the screen.)

After correcting the center frequency 0 MHz in the local feed through (zero waveform), the equipment returns to the setting before the execution of ZERO CAL, thus improving the center frequency accuracy.

Incidentally, although the ZERO CAL data is stored in the non-volatile memory, execute the ZERO CAL over again to read its correct value.

(3) CF CALibration

Press the _{CF CAL} key, the CF CAL and degaussing are executed. Since this equipment uses an oscillator capable of sweeping a wide band width as its local oscillator, an error occurs in the oscillation frequency for the setting when the center frequency is changed sharply (more than 1 GHz) where the frequency span is narrower (less than 200 MHz). This error can be removed by executing the CF CAL. To change the center frequency of the R4131 by 1 GHz or more, the frequency span is widened (as 2 GHz or 4 GHz span) in general. (Since the center frequency set resolution is 1/200 of the span, the center frequency does not move in big steps unless the span is widened.) Consequently, the sweeping is made under the status where the span is wide, and the degaussing is executed naturally. No CF CAL need be executed in this case.

Usually, it is not necessary to use this CF CAL. Use it only to move sharply the frequency where the span is narrow in the GPIB control, etc. CF CAL is not executed when the AFC function is turned ON in the R4131D/DN.

(4) CF ADJUSTMENT

Press the ^{SHIFT}, _{CF ADJ} keys, then CF ADJ is executed.
By using this function, the center frequency accuracy can be improved further using the known input signal.
The following is a description of the case where 2.2 GHz (11 times of CAL OUT 200 MHz) is used as the known frequency signal to read the value of an unknown frequency in the vicinity of 2.2 GHz.

- ① Set the center frequency to 2.2 GHz. (See Figure 4-3 (a).)
- ② Make the frequency span narrow in a range from which the spectrum does not protrude from the tube surface. (See Figure 4-3 (b).)
- ③ When the ^{SHIFT}, _{CF ADJ} keys are pressed, the frequency display remains unchanged, but the spectrum moves to the center and the center frequency accuracy becomes 11 times the CAL OUT signal accuracy. (See Figure 4-3 (c).)
- ④ Input an unknown frequency and read the frequency. (See Figure 4-3 (d).)

Although the value of the unknown frequency is obtained as 2199.5 MHz in this example, care should be taken, because value indicates the error of the CAL OUT signal and also the marker error.

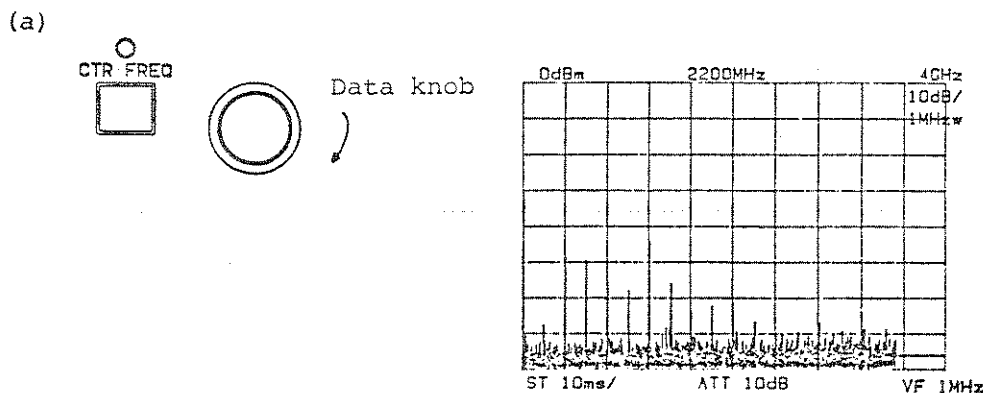

Figure 4-3 CF ADJ

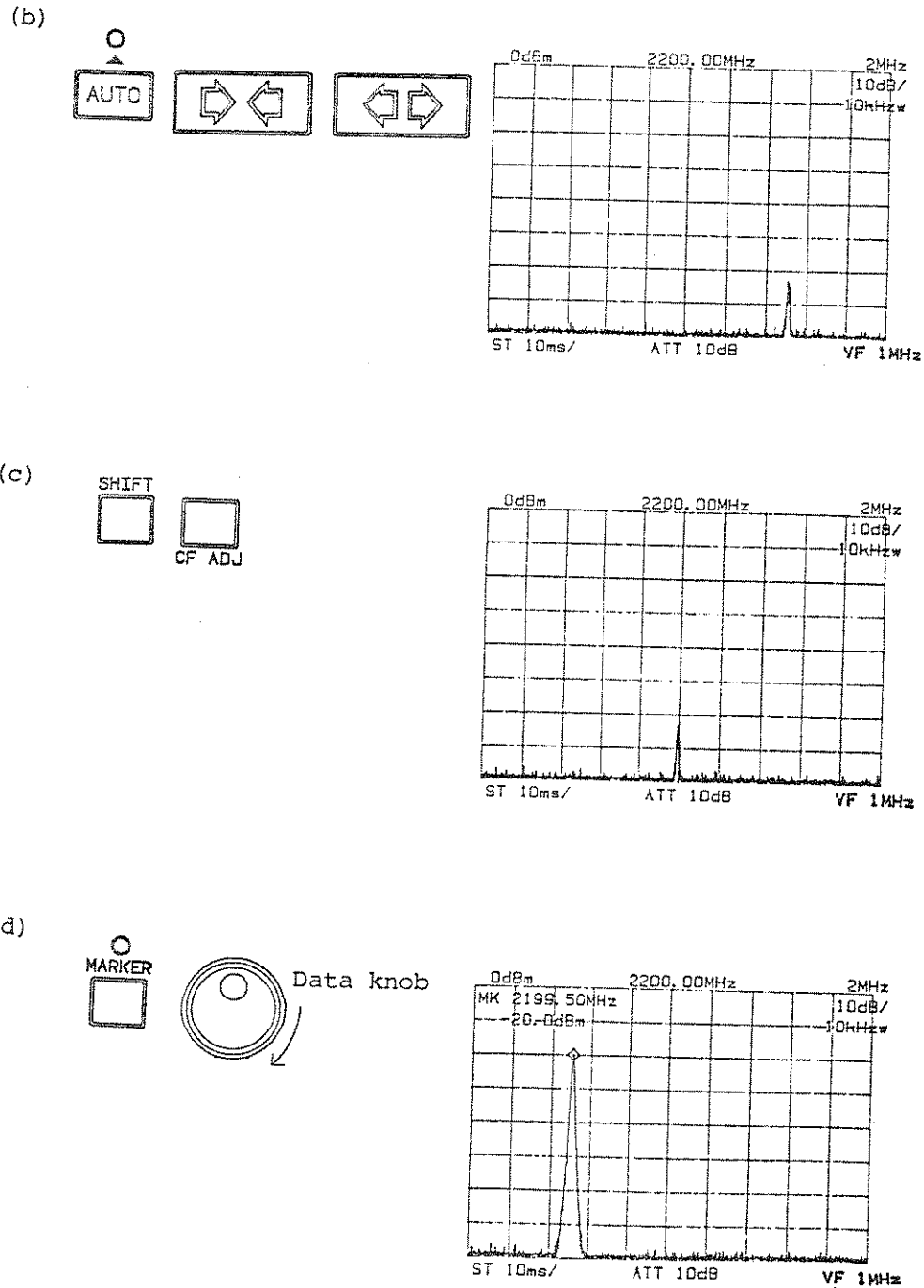







Figure 4-3 CF ADJ (cont'd)

4.4 Frequency Span

When the FREQUENCY SPAN SET mode is selected, the frequency range from 4 GHz to 50 kHz can be set with 1-2-5 steps by pressing the  or  key. The 1/10 of the set frequency span becomes the frequency span of one scale of the quadrature axis.

If the spectrum deviates from the center of the screen when the frequency span is narrowed, return the spectrum to the center of the screen by turning the data knob.

(1) What Is Zero Span (Displayed in the Time Axis)?

Pressing  , and  keys sets the ZERO SPAN mode, in which this equipment functions as a fixed tuning receiver and becomes a tube surface quadrature axis display. To clear this ZERO SPAN mode, press the  or  key.

When either key is pressed, the frequency span returns to the span before the setting of the ZERO SPAN mode.

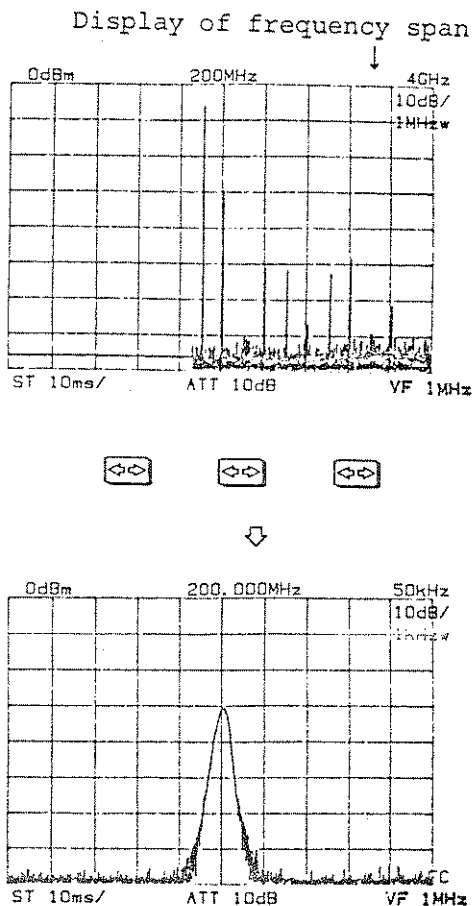

Figure 4-4 Making the Frequency Span Narrow and Spectrum Expand

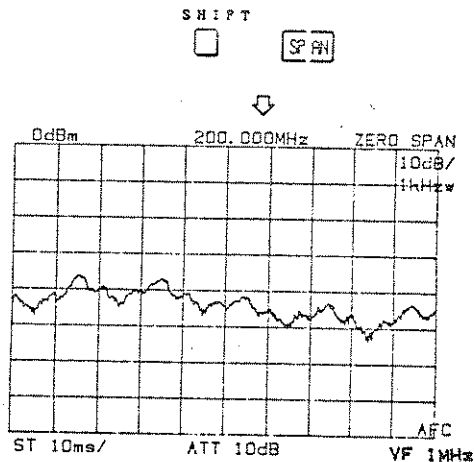

Figure 4-5 ZERO SPAN Mode

4.5 Interlocking Function (AUTO)

When the **AUTO** key is pressed and the LED on the key is lit, the frequency span, resolution band width (RBW) and sweep time are all interlocked to be set to the optimum condition when the **SPAN** or **SPAN** key is pressed. Incidentally, when the video filter band width (see Section 4.11) is changed, the video filter band width and sweep time are interlocked to be set to the optimum condition automatically.

4.6 Resolution Band Width (RBW)

When the LED on the **RT0** key is lit, the resolution band width is interlocked with the frequency span to be set automatically.

When **RBW** key is pressed and then **↔** or **↔↔**, the resolution band width can be set manually. When the **↔↔** key is pressed, the spectrum narrows and the resolution rises. It is therefore possible to separate the equipment from the nearby noise of the measured spectrum, or to separate spectrums themselves.

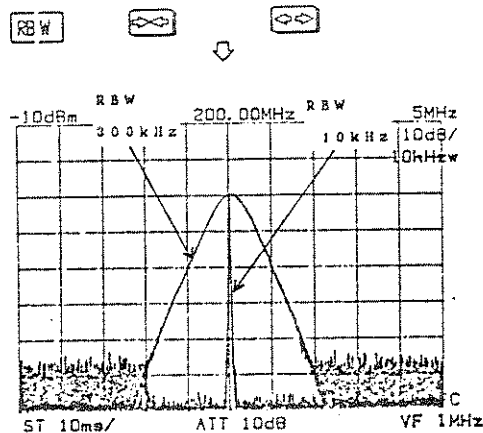



Figure 4-6 Change in Resolution Band Width

4.7 Reference Level and Ordinate Axis Scale



(1) Reference Level

The reference level is the top of the quadrature axis on the screen.

REFERENCE LEVEL

By pressing the   key, it is possible to set a range of -69.75 dBm to +40 dBm for R4131C/D and 40.25 dBμ to 150 dBμ for R4131CN/DN with a resolution of 0.25 dB maximum.

REFERENCE LEVEL

Each time the   key is pressed, the reference level goes up or down by one step.

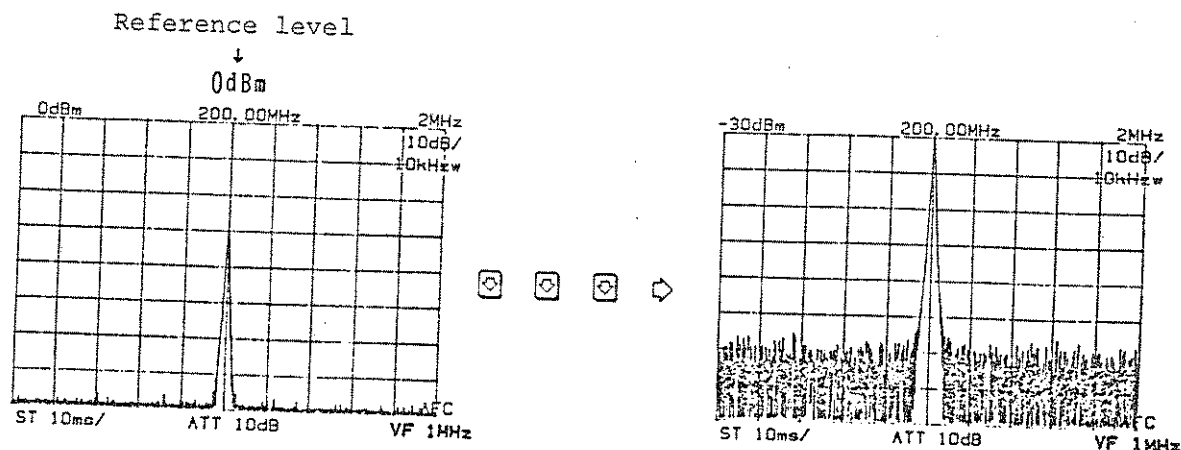







Figure 4-7 Change in Reference Level

(2) Quadrature Axis Scale (dB/DIV)

When the  and  keys are pressed, the ordinates axis scale is set to 10 dB/DIV.

When the  and  keys are pressed, the ordinates axis scale is set to 2 dB/DIV.

When the  and  keys are pressed, the ordinates axis scale is set to LINEAR.

In LINEAR, the lower end of the screen grid becomes 0 V.

R4131 SERIES
SPECTRUM ANALYZER
INSTRUCTION MANUAL

4.7 Reference Level and
Ordinate Axis Scale

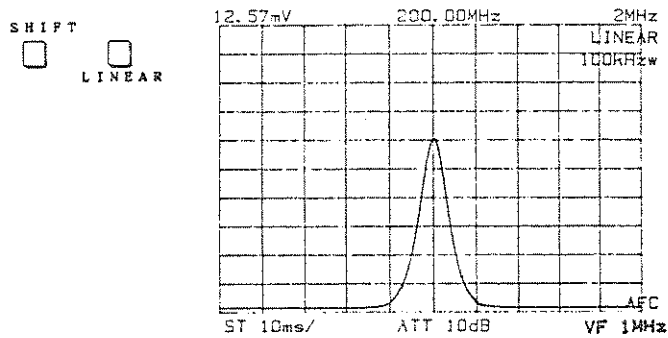
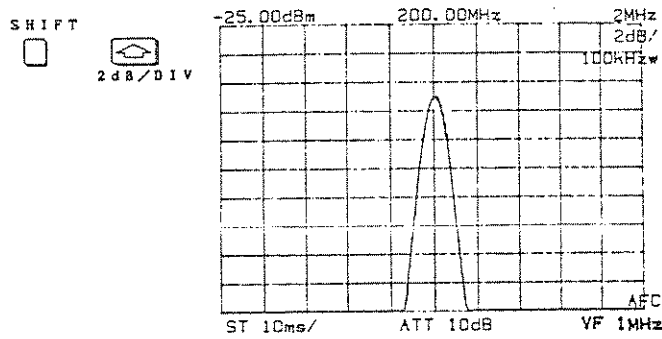
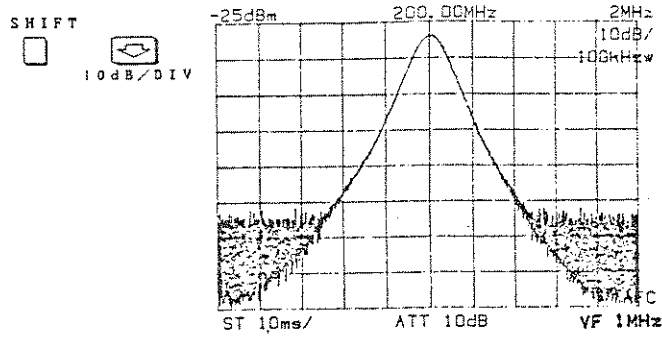

Figure 4-8 Ordinates Axis Scale

(3) Reference Level Step Width (COARSE/FINE)



When COARSE/FINE is selected in (the LED lights when selected to FINE), the step width becomes as shown in the table below at 10 dB/DIV and 2 dB/DIV:

Ordinates axis scale (dB/DIV)	Step width	
	COARSE	FINE
10 dB/DIV	10 dB	1 dB
2 dB/DIV	1 dB	0.25 dB

(4) Unit (UNITS)

When the ^{UNITS} key is pressed, four types of units, dBm, dBμ, dBμ/m (A through D) and dBmV can be selected in the reference level. The dBμ/m is described in Section 4.18 Measurement of Electric Field Intensity.

(5) Calibration of Ordinates Axis Level

The ordinates axis level can be calibrated by setting the signal level to -30 dBm using the variable resistor for calibrating the level display on the front panel with the calibration signal 200 MHz CAL. The ordinates axis level may change later in some cases if the calibration is executed before the equipment has warmed up for 30 minutes.

Care should also be taken because the ordinates axis level can change when the working temperature changes sharply.

4.8 RF Input Attenuator

INPUT ATTENUATOR

Pressing the , key sets the value of RF ATT between the INPUT connector and first mixer from 10 DB to 50 dB in steps of 10 dB. It is usually interlocked with the reference level to be set automatically.

Also, when the equipment is initialized the 10 dB attenuator is always set for the protection of the first mixer.

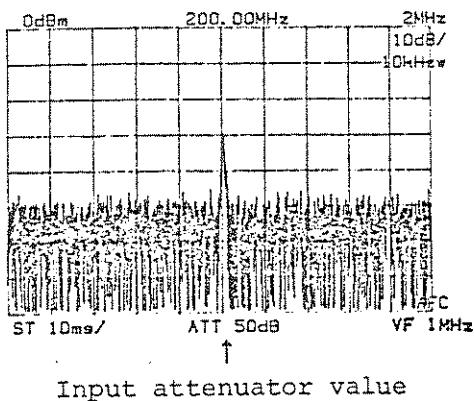

Figure 4-9 Input Attenuator Displaying Position

CAUTION

The attenuator can be set to 0 dB by pressing the , keys. However, set it after making sure that there is no excessive input signal throughout the frequency band width.

SHIFT INPUT ATTENUATOR

4.9 Display Line

When the ^{SHIFT}, _{DSPL LINE} keys are pressed, the display line is displayed on the screen.

The display line is a horizontal cursor line for the level comparison of waveform. Its data is displayed on the screen as "DL = xx dBm". (See Figure 4-10.) Each time the and keys are pressed, the display line can be moved up and down.

As in the reference level, the display line can be changed by selecting the COARSE/FINE using the _{COARSE} _{FINE} key with the following step widths:

COARSE: 1 DIV
FINE : 1/10 DIV

To erase the display line, press the ^{SHIFT}, _{DSPL LINE} again.

Also, the display line is used for the reference line in the normalizing function and for the level setting in the signal tracking function.

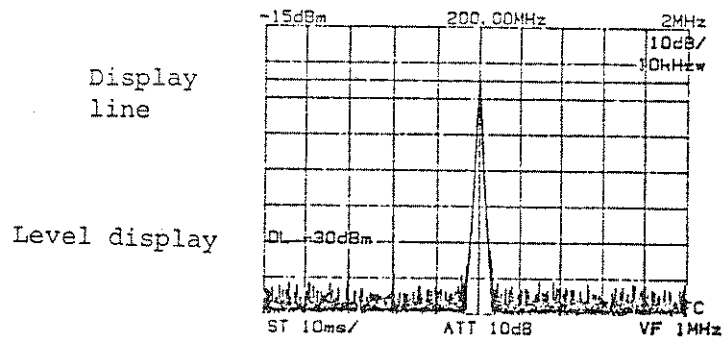

Figure 4-10 Display Line

4.10 Marker Function

(1) Display of Marker

When the ^{MARKER} key is pressed, the \diamond shaped marker appears in the center of the frequency axis or a previously set position. In addition, the frequency and level of the marker are displayed on the upper left of the screen. The marker can be moved freely on the trace using the data knob.

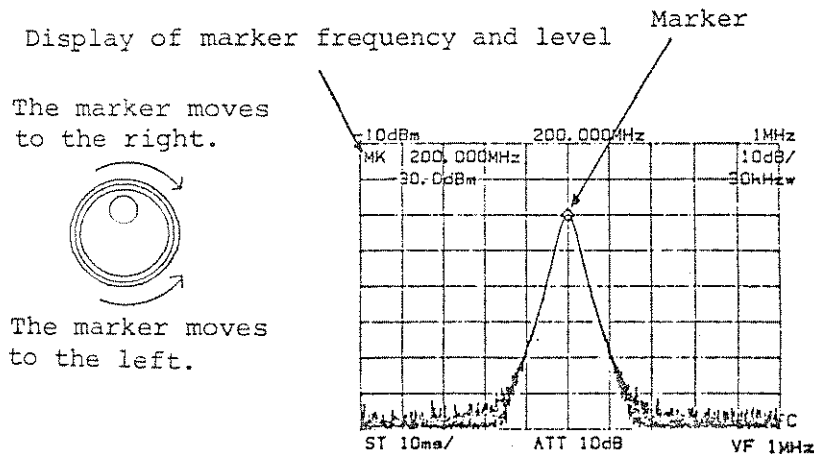

Figure 4-11 Operation of Marker

If the ^{CTR FREQ} key is pressed when the marker is displayed on the screen, the data knob is made into the mode to change the center frequency and the marker is fixed on the frequency axis at that time and not erased.

(2) Erasing of Marker

When the ^{OFF} key is pressed, the display of the marker and marker data is erased.

When the ^{MARKER} key is pressed once more, the marker appears again on the frequency axis where it had disappeared.

(3) PEAK Search

When the ^{PEAK} key is pressed, the marker moves to the peak of the waveform with the highest level on the trace (Figure 4-12). This is a convenient function for setting the marker to the measuring signal.

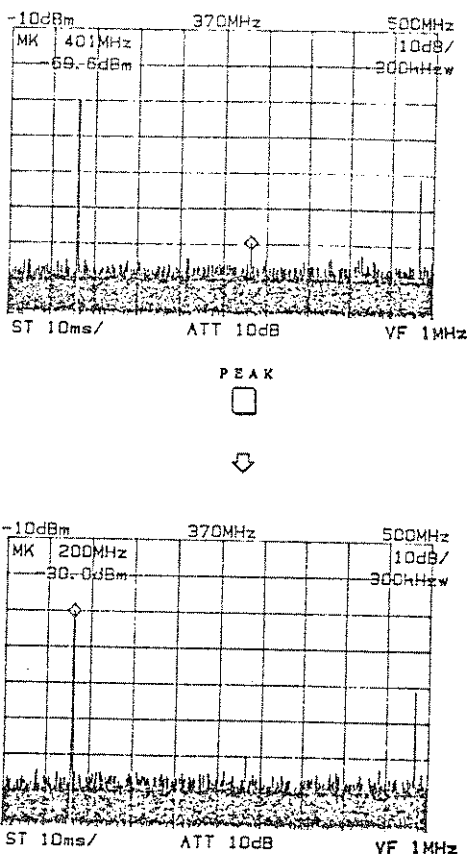

Figure 4-12 PEAK Search

(4) MarKeR → Center Frequency

When the $\overset{\text{MKR} \rightarrow \text{CF}}{\square}$ key is pressed, the marker and spectrum on which the marker is present move to the center of the screen to coincide with the center frequency. (Figure 4-13)

The spectrum can also be moved to the center of the screen by setting the center frequency using the known data. When this key is used, the spectrum can be moved to the center very quickly.

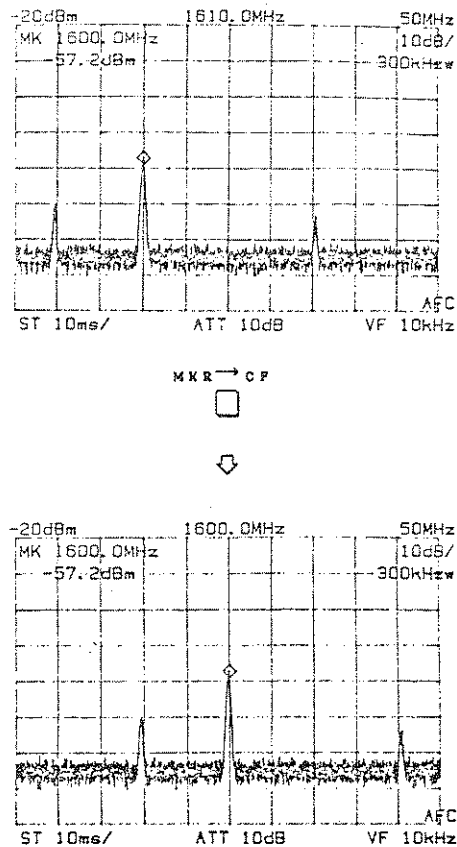

Figure 4-13 MarKeR → Center Frequency

(5) Signal TRack

When the ^{SHIFT} and SIG TRK keys are pressed, the signal tracking function operates.

When this function is used, the frequency with the highest peak on the screen is automatically set as the center frequency each time the sweeping is done and when adopted makes it possible to always seize the signal in the center of screen, even if the signal drifts.

The signal tracking function of this equipment merely performs the PEAK searching on the screen and repeats it for each sweeping as MKR CF. However, the PEAK searching level can be selected by the display line. It is therefore possible to track only the signal which is higher in level than the display line.

By this, the center frequency never flies off due to noise without tracking the signal, even if the input signal is missed temporarily.

Press the ^{SHIFT} and ^{DSPL LINE} keys, and the display line is displayed on the screen.

Then, move the display line using the 10 dB/DIV and 2 dB/DIV keys to determine the level for PEAK searching.

When the ^{SHIFT} and ^{SIG TRK} keys are pressed, the signal above the value determined by the display line is tracked. (See Figure 4-14.)

Even if the display line is erased, the signal tracking is still carried out with the value determined earlier. To clear the signal tracking function, press the ^{SHIFT} and ^{SIG TRK} keys over again, or press the ^{MARKER OFF} KEY.

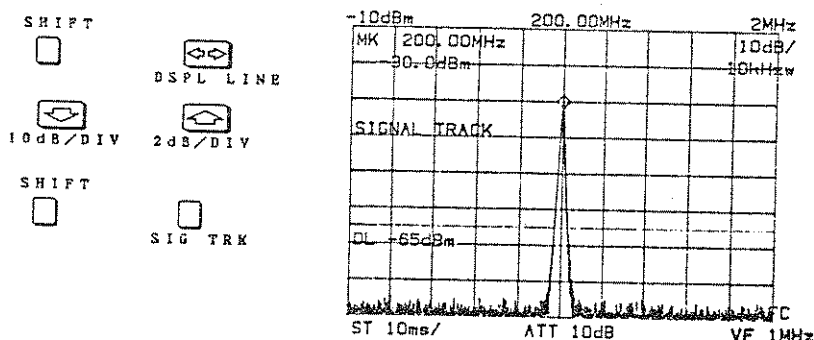

Figure 4-14 SIGNAL TRACK

(6) MARKER PAUSE

After making the marker display on the screen, press the ^{MARKER} and ^{TIME/DIV} keys, or ^{MARKER} and ^{TIME/DIV} keys in succession, then the MARKER PAUSE function operates.

This function stops the sweeping temporarily at the position of the marker. Although the stop time is 1 sec at first under the MARKER PAUSE status, it can be changed from 1 sec, in steps of 0.5 sec. It can be set in steps of 0.5 sec between 0 and 10.0 sec. (See Figure 4-15).

To clear this MARKER PAUSE function, set the stop time to 0 sec by repeatedly pressing the ^{MARKER} and ^{TIME/DIV} keys, or press the ^{MARKER OFF} key.

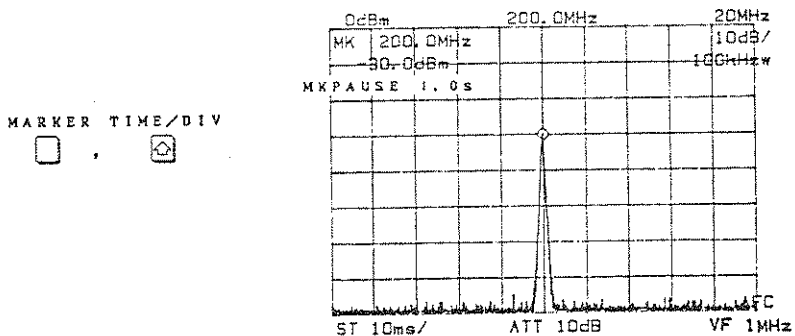

Figure 4-15 MARKER PAUSE

(7) Measurement of NOISE/Hz

After displaying the marker on the screen, press the and ^{SHIFT} _{NOISE/Hz} keys in succession, then the NOISE/Hz function operates.

This function can measure the rms of the noise level which is normalized by the noise voltage band width of 1 Hz at the marker position.

The display detection mode at this time is automatically set to the SAMPLE DET. (See Figure 4-16.)

To clear the NOISE/Hz function, press the and ^{SHIFT} _{NOISE/Hz} keys again.

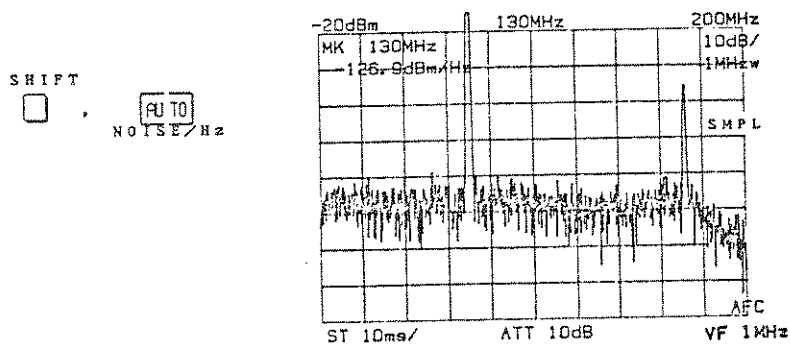



Figure 4-16 Setting of NOISE/Hz

4.11 Video Filter Band Width (VIDEO FiLTeR)

4.11 Video Filter Band Width (VIDEO FiLTeR)

Each time the  key is pressed, the video filter band width can be changed with seven steps of 1 MHz \leftrightarrow 300 kHz \leftrightarrow 100 kHz \leftrightarrow 10 kHz \leftrightarrow 1 kHz \leftrightarrow 100 Hz \leftrightarrow 10 Hz.

Also, the video filter band width is interlocked with the sweep time to be set automatically to the optimum sweep time.

When the video filter band width is made smaller step by step, the signal which is buried in noise can be searched for, but it takes a long sweep time.

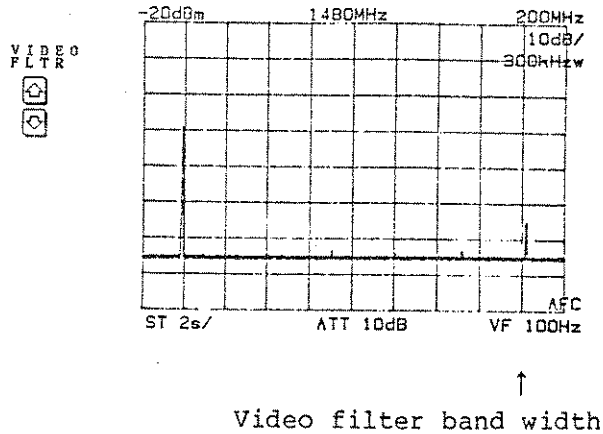



Figure 4-17 VIDEO FiLTeR

4.12 Setting of Sweep Time

Since the equipment is set to AUTO at initialization, the sweep time is automatically set to a range which does not cause a level error for the frequency span, resolution band width, and VIDEO FILTER, etc.

TIME/DIV



When the  key is pressed, the automatic setting is cleared and the sweep time can be set to a range from 5 ms/DIV to 100 s/DIV in steps of 1-2-5. The message "UNCAL" is displayed in the center of the screen when it is set in a manner to cause an error in the level display because of too rapid sweeping. Change the measuring condition, by making the sweep time longer for instance. (See Figure 4-18.)

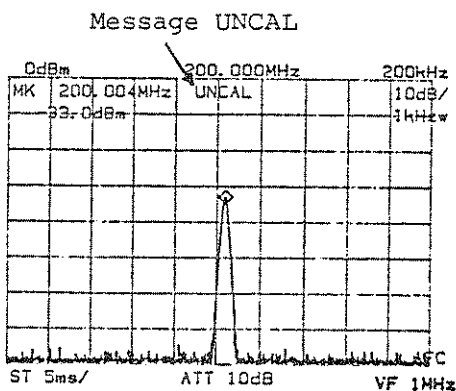

↑
 Sweep time

Figure 4-18 Sweep Time

4.13 Selection of Sweep Mode/Trigger Mode

4.13 Selection of Sweep Mode/Trigger Mode

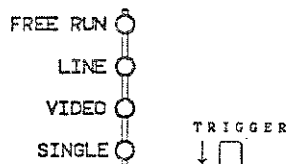

Each time the keys are pressed, the TRIGGER mode is select in the order of FREE RUN → LINE → VIDEO → SINGLE. The LED corresponding to the selected mode will then light.

- FREE RUN: This is a continuous sweep mode to automatically repeat the sweeping internally.
- Line : This is a mode to repeat the sweeping in synchronism with the AC power supply frequency.
- VIDEO : Triggered by the waveform which detected the IF signal.

SINGLE : This is a single sweep mode and controlled by the key.

START
/RESET

When the key is pressed in the single sweep mode, the sweeping is executed once.

When the key is pressed in the middle of sweeping, the sweeping is reset for the next single sweeping. This function is used to retry sweeping during screen rewriting when the sweep time is long.

4.14 Display Detection Mode

This is the mode to specify which amplitude value should be converted from analog to digital when the amplitude data within a certain time during the sweeping is converted from analog to digital.

This display detection mode affects the display of noise or that of impulsive signals.

(1) SAMPLE DETECTION

When the ^{SHIFT} and <sub>SAMPL
DET</sub> keys are pressed, the SAMPLE DET mode is selected and "SMPL" is displayed in the middle right of the screen. (See Figure 4-19.)

This mode displays the result of sweeping at moments set at each point of the frequency axis.

The SAMPLE DET mode is set automatically for measurement of the NOISE/Hz.

(2) POSi PeaK DETECTION

- R4131D/DN

When the ^{SHIFT} and <sub>POS PK
DET</sub> keys are pressed, the system goes into the POS PK DET mode.

This mode displays the maximum value during the period set at each point of the frequency axis.

Since this POS PK DET mode soundly seizes the spectrum peak, it is effective for the level measurement of a fine spectrum. (See Figure 4-20.)

- R4131C/CN

R4131C/CN is set to the POS PK DET mode when it is initialized.

(3) NORMAL DETECTION (POSI/NEGA DET)

- R4131D/DN

When the ^{SHIFT} and <sub>NORMAL
DET</sub> keys are pressed, the system enters the POSI/NEGA PK DET mode.

This mode displays the maximum value or minimum value of the periods set at each point of the frequency axis. (See Figure 4-21.)

R4131D/DN is set to the NORMAL (POSI/NEGA) DET mode when it is initialized.

- R4131C/CN

When the ^{SHIFT} and <sub>NORMAL
DET</sub> keys are pressed, the system enters the POSI PK DET mode.

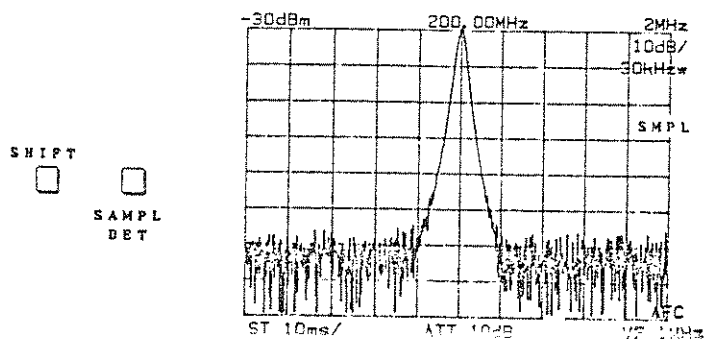

Figure 4-19 SAMPLE DET (R4131)

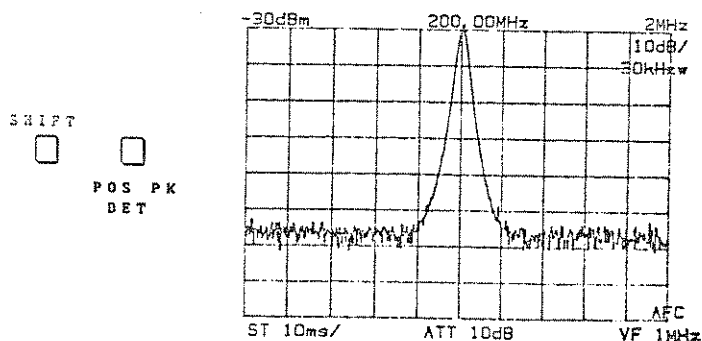

Figure 4-20 POSI PK DET (R4131)

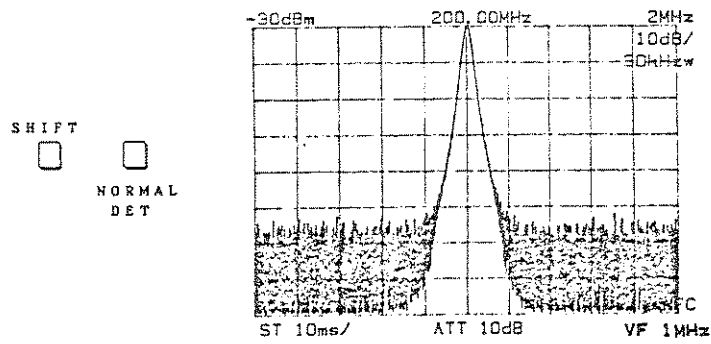
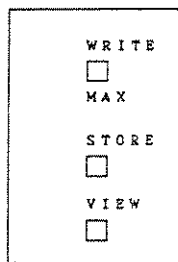

Figure 4-21 NORMAL DET (R4131B/BN/D/DN)

4.15 Selection of Trace Mode

The trace memory of this equipment provides two memories. One is the WRITE memory which rewrites the data for each sweeping the other is the VIEW memory which stores the waveform for any screen of the WRITE memory. The waveform of the WRITE memory or VIEW memory can be called, or both can be displayed on the screen to make a two-screen display.



(1) WRITE

When the ^{WRITE} key is pressed, the memory contents are rewritten at each sweeping.

The waveform of the WRITE mode is rewritten for each sweeping. The trace mode at initialization is set to this WRITE mode.

(2) STORE

When the ^{STORE} key is pressed, the waveform data written in the WRITE mode at that time is held in the memory. The screen displays the waveform data held in the memory and then holds still. In other words, the system enters the VIEW mode and the leftward LED of the ^{VIEW} key lights.

(3) VIEW

The ^{VIEW} key is used to call the waveform stored in the WRITE memory in the WRITE mode. Since the stored waveform data keeps its contents until new waveform data is stored again in the WRITE mode, this function is convenient for the comparative survey between the WRITE waveform after a change in setting conditions and the stored waveform data (the VIEW data).

(4) WRITE and VIEW (2-screen display)

When the display data, which is rewritten each sweeping by means of the ^{WRITE} key, is stored and the ^{STORE} key is pressed again, both leftward LEDs of the ^{VIEW} and ^{WRITE} keys light and the stored waveform data and the sweep data in the WRITE mode are displayed in two screens. To return the two screens to a single screen, erase the unnecessary screen using the ^{WRITE} or ^{VIEW} key.

The following describes how to use this function taking the comparative measurement of the secondary harmonic level as an example.

Operating procedure

- ① Input the signal of CALibration OUTput, 200 MHz and -30 dBm, of this equipment.
- ② Set as follows:
Center frequency 200 MHz
Reference level -30 dBm
Frequency span 10 MHz
In addition, set the POS PK DET to make it easier to compare two screens.
- ③ Set the spectrum of the measured signal to the center of the screen (Figure 4-22).

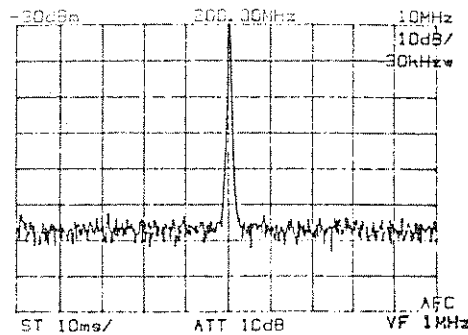

Figure 4-22 Setting the Measured Signal to the Center Frequency

- ④ Press the ^{STORE} key.
Then, the trace mode becomes VIEW. The sweeping stops, the last sweep waveform is displayed, and the screen stands still. This data is stored in the internal memory.
- ⑤ Press the ^{WRITE} key.
Then, a new WRITE waveform data is displayed together with the waveform of the memory (Figure 4-23).

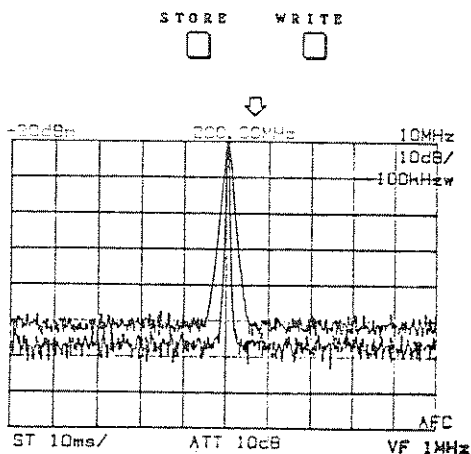

Figure 4-23 Two-screen Display with a New WRITE Waveform

- ⑥ Set the center frequency to 400 MHz and make the secondary harmonic wave move to the center of the screen. Then, the measured value can be read from the difference in display between the two screens. (Figure 4-24)

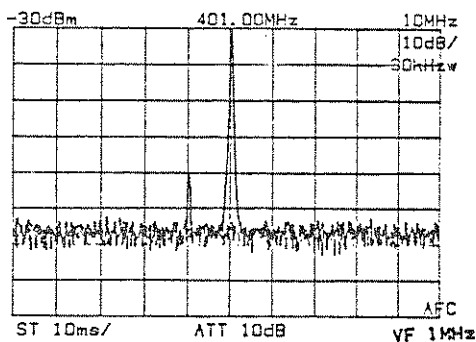

Figure 4-24 Two-Screen Display of Secondary Harmonic wave and STORE Waveform

To erase the VIEW waveform while it is kept held in the memory to observe the secondary harmonic wave (WRITE waveform) further, press the key, Then, the screen becomes a single screen display of the WRITE waveform.

To display the memory waveform only, press the key. That is, press the key on the erased side.

(5) MAX HOLD

When the and keys are pressed, the stored data is rewritten and displayed on the screen, at each sweeping, any data that exceeds the former level at each point on the frequency axis is updated.

Consequently, the screen displays the maximum value up to then, for each point. (Figure 4-25)

In Figure 4-25, it can be seen that the signal is drifting in a range of approx. 4 MHz by putting it on MAX HOLD.

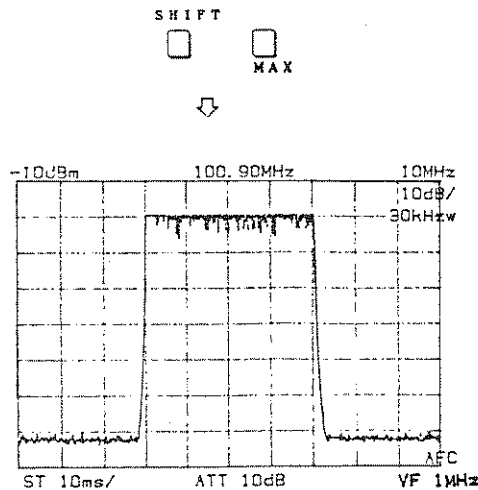

Figure 4-25 MAX HOLD

When the ^{WRITE} key is pressed once more, the maximum held contents and WRITE waveform are displayed in two screens, and at the same time, the WRITE waveform is compared with the maximum held contents. When the former is larger, that value is stored in the memory (Figure 4-26).

To release MAX HOLD, after setting to 2-screen display as shown in Figure 4-26, clear it by pressing the ^{SHIFT} and ^{MAX} keys again: or after setting the maximum held waveform to the VIEW mode by pressing ^{STORE} or ^{VIEW} key, erase the unnecessary screen by pressing the ^{VIEW} or ^{WRITE} key.

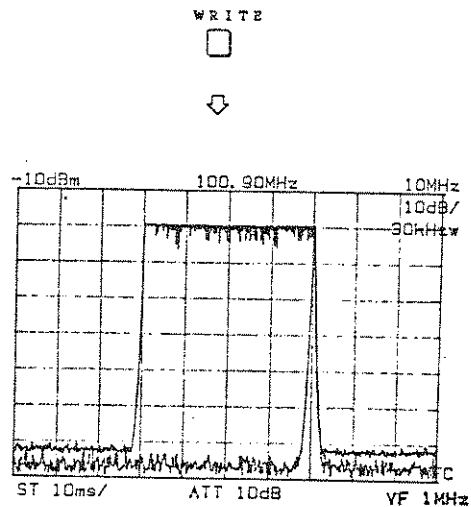

Figure 4-26 Two-screen Display of The Maximum Hold Contents and WRITE Waveform

4.16 Setting Conditions and SAVE/RECALL of Displayed Waveform

This equipment can save three states of the displayed waveform and its setting conditions as shown in table 4-2 in the non-volatile memory.

This function is convenient, because the setting conditions and displayed waveform can be recalled when the system is set up again since they are saved in the memory even if the power is turned OFF. It is also possible by using this function to compare waveforms and to block them out all together since the displayed waveforms can be recalled.

Table 4-2 SAVE/RECALL Enabled Panel Setting

Center frequency
Frequency span
Interlocking function (AUTO)
Resolution band width
Reference level
Reference level step width (COARSE/FINE)
INPUT attenuator
Video filter band width
Sweep time

When the setting conditions and displayed waveforms saved in the memory are recalled, the setting conditions are set in the WRITE screen at first and then the saved waveforms are recalled on the VIEW screen.

It is possible by pressing the ^{VIEW}
 key to see the waveforms which were saved in the memory (Figure 4-27).

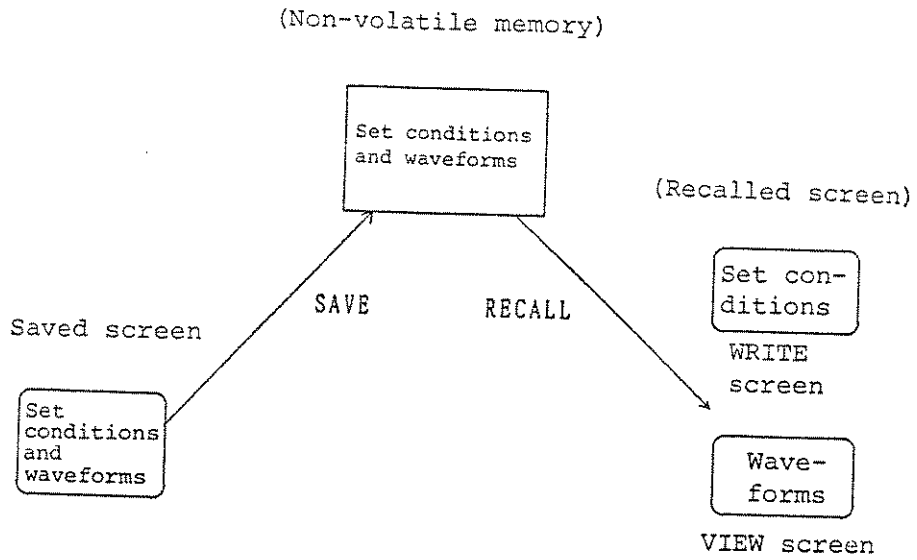

Figure 4-27 SAVE/RECALL Waveform Memory

Table 4-3 shows the relations with the screen stored in the memory in each trace mode.

Table 4-3 Screen Stored in Each Trace Mode

Trace mode	Screen stored
WRITE DISPLAY only	Stores the WRITE screen.
VIEW display only	Stores th VIEW screen.
WRITE/VIEW display	Stores the WRITE screen.
MAX HOLD only	Stores the MAX HOLD screen.
WRITE/MAX HOLD display	Stores the WRITE screen.

(1) SAVE

When the ^{SHIFT} and _{SAVE} keys are pressed, the system is enters the SAVE mode and the screen becomes as shown in Figure 4-28.

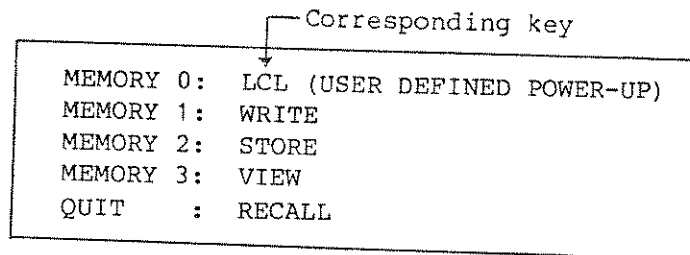

Figure 4-28 SAVE Screen

Select the MEMORY 1, MEMORY 2, or MEMORY 3 using ^{WRITE}, ^{STORE}, or ^{VIEW} key and select the memory to store.

To quit the SAVE mode halfway, press the ^{RECALL} key.

The MEMORY 0 is described in Section 4.17 Automatic Setting at Power ON.

(2) RECALL

When the ^{RECALL} key is pressed, the system enters the RECALL mode and the screen becomes as shown Figure 4-29.

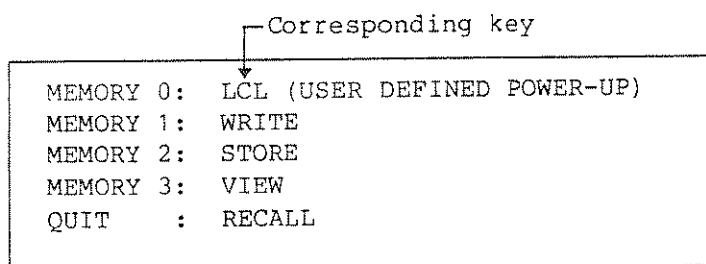

Figure 4-29 RECALL Screen

Select the MEMORY 1, MEMORY 2, or MEMORY 3 by using the ^{WRITE}, ^{STORE}, or ^{VIEW} key to select the memory to call.

To quit the RECALL mode halfway, press the ^{RECALL} key.

4.17 Automatic Setting at Power ON

This is a function to call the setting stored in the non-volatile memory each time the power is turned ON. The setting of the equipment selected by yourself can always be called at power ON.

To store the setting to appear at power ON, press the ^{SHIFT} and _{SAVE} keys to put the system into the SAVE mode.

Then, the screen becomes as shown in Figure 4-28.

Press the MEMORY 0 and ^{LCL} keys, then the set conditions are stored in the memory.

4.18 Electric Field Intensity Measurement (dB μ /m)

The spectrum analyzer which can observe a wide frequency band at a time can also be used as a field intensity measuring instrument. When an antenna manufactured by ADVANTEST is used, this analyzer displays the level data by correcting the antenna factor, making it possible to read directly the field intensity through this analyzer. However, this correction value is effective only when the attached 5D2W cable, 10 m. is used. When using any other cable an error results.

Operating procedure

- ① Connect the antenna to the input terminal (50 Ω) of this equipment. When the impedance of the antenna is not 50 Ω , be sure to match the impedance using a matching circuit.
- ② Set the center frequency and frequency span, etc., to facilitate the observation.
- ③ Press the ^{UNITS} key and select the level unit to match the antenna as follows:

For TR1722 half-wave dipole antenna: dB μ /m (A)
For TR1711 log helical antenna : dB μ /m (B)
For TR17203 active antenna : dB μ /m (C)
For TR17204 log helical antenna : dB μ /m (D)

- ④ Press the ^{PEAK} key and set it to the peak of the spectrum to measure the marker.

The relationship between the marker point display level, that is, the input end voltage e_x (dB μ V) of this equipment, and the actual field intensity E_x (dB μ V/m) is as shown below:

$$E_x = e_x + K \quad \text{Where, K: antenna factor (dB)}$$

When the above antenna is used, this antenna factor K is automatically corrected and the marker display indicates the field intensity.

When any antenna other than those mentioned above is used, correct the value referring to the following "Correction Coefficient of Antenna":

- Correction Factor of Antenna

$$E_x = e_x + K = (e_x + 6) + L_a - H_e + B_a$$

Where,

- EX : Field intensity (dB μ V/m)
- e_x : Input terminal voltage (dB μ V)
- K : Antenna correction factor (dB)
- H_e (dB): Effective length of antenna
- L_a (dB): Cable loss
- B_a (dB): Balun loss

The factor K of the half-wave dipole antenna is obtained according to the following equation:

$$K = 20 \text{ Log } \frac{\pi}{300} F + 6 + L_a + B_a \quad F \text{ (MHz): Receiving frequency}$$
$$= -33.6 + 20 \text{ Log } F + L_a + B_a$$

For the broad band width logarithm frequency type antenna, deduct the antenna gain (half-wave dipole antenna ratio) from the obtained value.

Figure 4-30 shows the relationship between the frequency and calibration factor of TR1722 half-wave dipole antenna (including the cable loss).

4.19 QP Value Measurement (Quasi-peak Value Measurement)

The QP value measurement is for measuring the pulse characteristic noise. Various constants in this measurement are defined values in the CISPR Standards as shown in Table 4-4.

Table 4-4 CISPR Standards for QP Value Measurement Basic Characteristic

Measuring band	6 dB band width	Charging time constant	Discharging time constant	Mechanical time constant
A 10 kHz to 150 kHz	20 Hz	45 ms	500 ms	160 ms
B 150 kHz to 30 MHz	9 kHz	1 ms	160 ms	160 ms
C 30 MHz to 300 MHz	120 kHz	1 ms	550 ms	100 ms
D 300 MHz to 1 GHz	110 kHz	1 ms	550 ms	100 ms

Note: This equipment has no A-range (10 kHz to 150 kHz, and 200 Hz band width).

Operating procedure

- ① Set the center frequency and frequency span to be measured. Since the QP band width is automatically set as the center frequency is set, select the frequency span in the band to be measured. For B-band for instance, the center frequency and span are selected as 25 MHz and 5 MHz, respectively.
- ② While observing the waveform, press the ^{INPUT} and ^{ATTENUATOR} keys and increase or decrease the input attenuator with in steps of 10 dB to check that the waveform level does not change. If changed, it indicates that the input stage of this equipment is saturated, so increase the attenuator value or add B.P.F (Band Pass Filter) to its input.
- ③ When the level can be checked not to change, change the reference level so that the output peak level meets the reference level.
- ④ Press the ^{SHIFT} and _{ap} Keys.

The system enters the QP measurement mode under this status and the screen becomes 5 dB/DIV and eight scales.

- ⑤ Since a large time constant is entered when the QP value is measured as shown in Table 4-4, make the sweep time long enough. As a yardstick in this setting, set 1 sec per 10 kHz in the measuring band B (150 kHz to 30 MHz) and 1 sec per 10 kHz in the measuring bands C and D (30 MHz to 1 GHz).

- ⑥ Press the ^{MARKER} key to output the marker.

Then, the QP value of the input terminal is displayed in terms of the marker frequency.

- ⑦ When an antenna manufactured by ADVANTEST is used, press the ^{UNITS} key and set the level unit to the antenna and select the unit as follows:

TR1722 half-wave dipole antenna: dB μ /m (A)
TR1711 log helical antenna : dB μ /m (B)
TR17203 active antenna : dB μ /m (C)
TR17204 log helical antenna : dB μ /m (D)

Then, the antenna factor is automatically corrected, the level unit at the marker point becomes dB μ /m, and the QP value is displayed directly on the screen.

This correction is made only when the attached 5D2W antenna, 10 m, is used. When any other antenna is used, obtain the correction factor referring to the electric field intensity measurement in Section 4.18 and calculate the QP value.

- ⑧ Press either one of the ^{SHIFT}  ^{10dB/DIV'}, ^{SHIFT}  ^{2dB/DIV'}, or ^{SHIFT} ^{LINEAR} key, and the QP value measurement mode is cleared and the setting is changed accordingly.

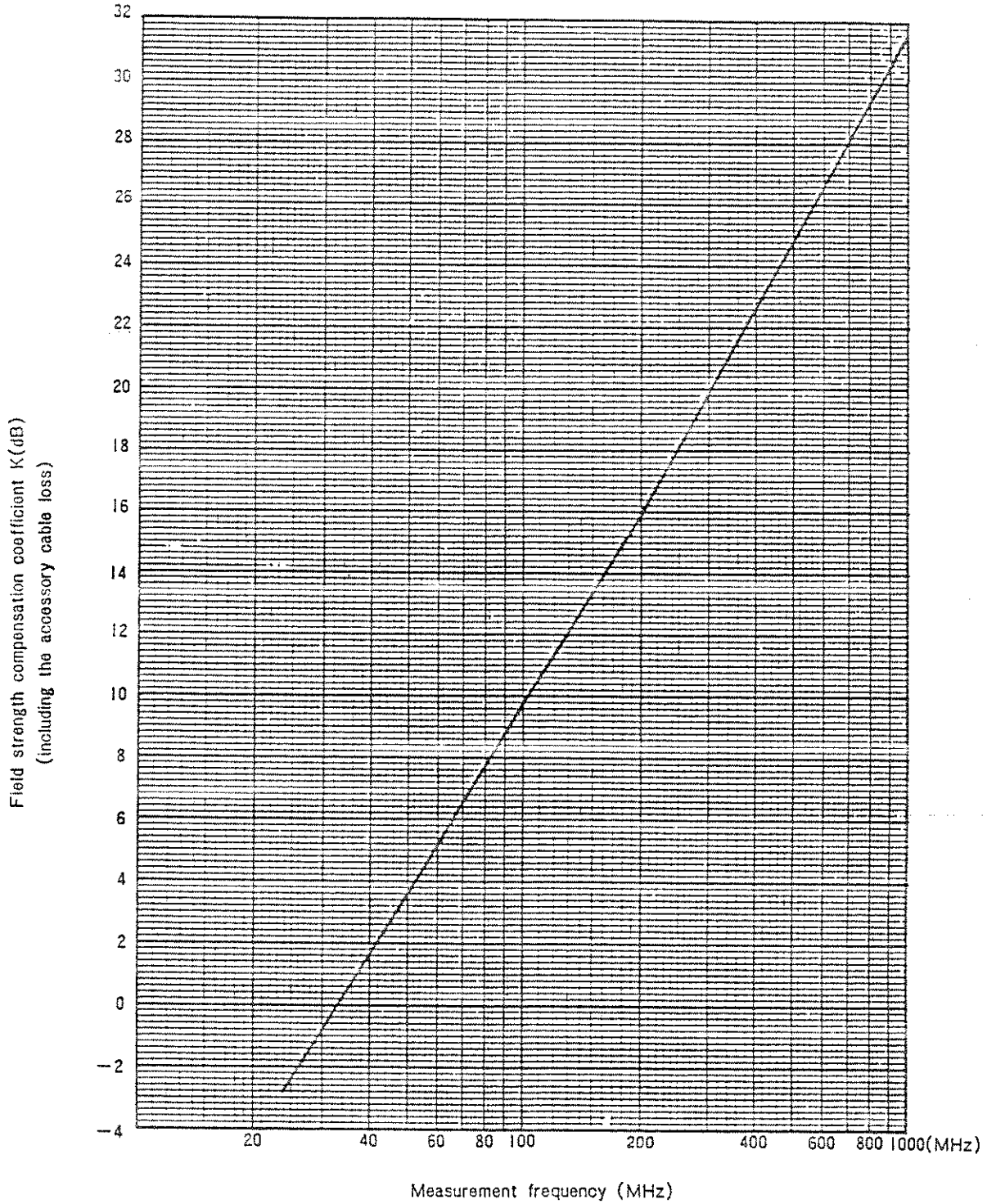

Figure 4-30 Relationship between Frequency and Calibration Factor in the half-wave dipole antenna

4.20 Normalize

The normalizing function is used to correct the frequency characteristic of this equipment itself and measuring systems including this equipment and to perform a relative comparison of displayed waveforms on the tube surface.

The following is the operating procedure for the measurement of the insertion loss of high frequency cables using the TR4153A/B tracking generator as an example.

Operating procedure

- ① Connect this equipment to TR4153A/B through the measuring system excluding the cable to be measured (Figure 4-31).

(The frequency characteristic in this measuring system includes the insertion loss of the connected cable and the frequency characteristic of this equipment. The cable insertion loss of the measured device is measured on the basis of this characteristic.)

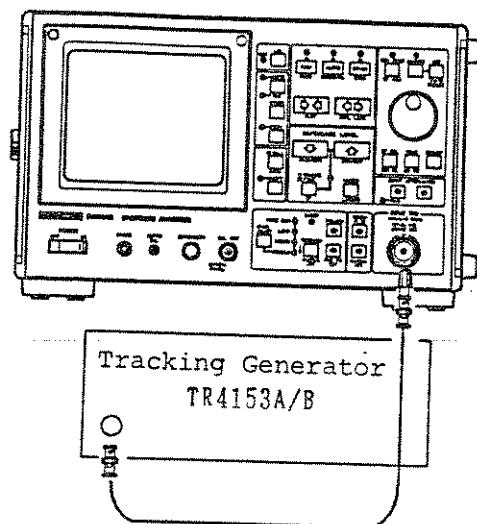

Figure 4-31 Direct Connection between Tracking Generator and System

- ② TRACE : Set to WRITE (Initialization)
dB/DIV.: Set to 2 dB/DIV
Span : Set to 2 GHz

- ③ To change the reference level and to widen the dynamic range on the lower side of the tube surface for measurement of the cable loss, move the through waveform to the upper side of the tube surface as shown in Figure 4-32.

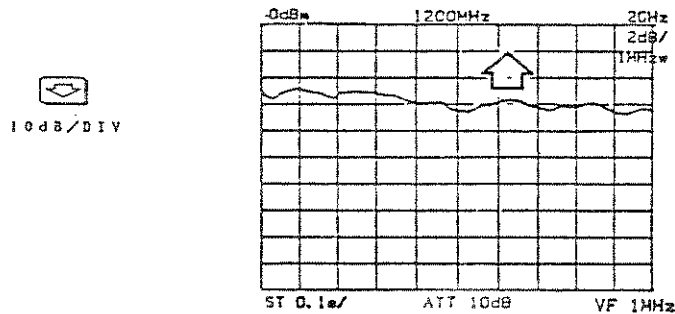

Figure 4-32 Moving the through Waveform

- ④ Then, the Display Line is Displayed on the Screen.



Move the display line close to the through waveform to make it the reference line of the normalizing (Figure 4-33).

The display line can be moved using the key.
2dB/DIV

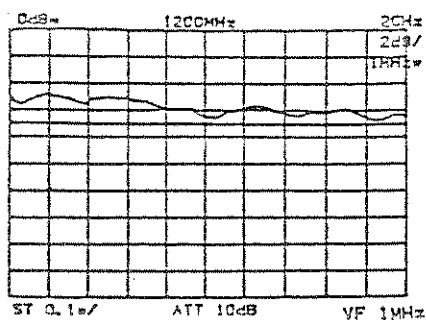

Figure 4-33 Moving the Display Line

⑤ Normalize

When the ^{SHIFT} and ^{RBW}/_{NORM} keys are pressed, the frequency characteristic of the measuring system is corrected and "NORM" is displayed on the tube surface and the through waveform coincides with the display line (Figure 4-34).

When the ^{SHIFT} and ^{RBW}/_{NORM} keys are pressed directly without making the display line display, the level in the center of the tube surface is normalized as the reference line.

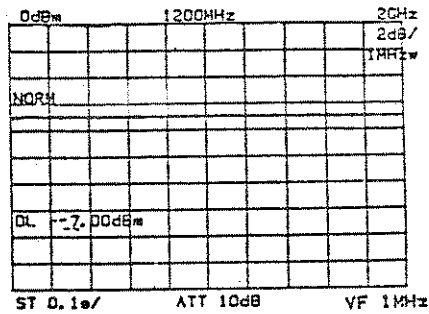

Figure 4-34 Normalize

- ⑥ Observation of insertion loss of a cable to be measured

Connect the measured cable to this equipment (Figure 4-35).

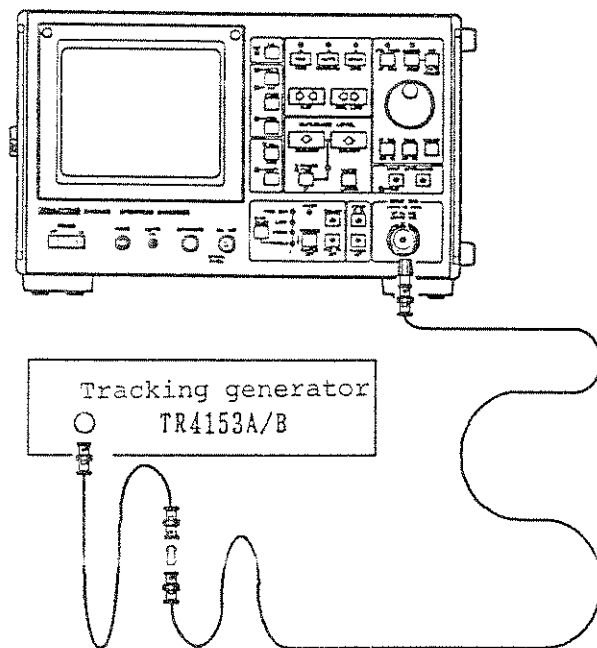

Figure 4-35 Connection of Measured Cable

- ⑦ Then, the measured waveform is displayed apart from the display line according to the cable loss (Figure 4-36).

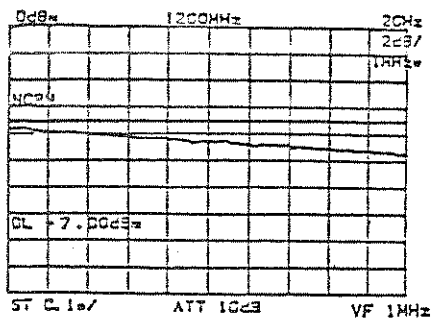

Figure 4-36 Cable Loss Characteristic

- ⑧ When the marker is displayed, the relative value between the marker point on the measured waveform and display line can be read directly in the marker level (Figure 4-37). To clear the NORMALIZE mode, press the ^{SHIFT} and _{NORM} keys again.

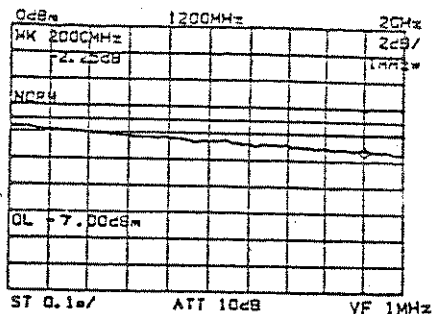

Figure 4-37 Reading the Characteristic of Waveform from the Marker Display

4.21 Occupied Frequency Band Width (OBW) Measurement (only for R4131D)

This function is mounted on R4131D only. This function obtains the occupied frequency band width from the data on the screen measured with this equipment. This operation is made as follows:

There are 701 points of data for the frequency axis on the screen of this equipment. Where one of the voltage is taken as V_n , the total power P on the screen can be obtained according to the following equation:

$$P = \sum_{n=1}^{701} \frac{V_n^2}{R} \quad (R: \text{Input impedance of this equipment})$$

If X is taken as the point at which the sum of the power levels being displayed in sequence from the left end of the screen becomes 0.5% of P , the following equation can be established:

$$0.005 P = \sum_{n=1}^X \frac{V_n^2}{R}$$

If Y is taken as the point at which the sum of the power levels being displayed in sequence from the left end of the screen becomes 99.5% of P , the following equation can be established:

$$0.995 P = \sum_{n=1}^Y \frac{V_n^2}{R}$$

Obtain X and Y from the above three equations and obtain the occupied frequency band width (OBW) from the frequency span SPAN according to the following equation:

$$OBW = \frac{fSPAN (Y-X)}{701}$$

The following is the operating procedure of the OBW display.

Operating procedure

- ① Make the spectrum to be measured display in the center of the screen and set the screen ordinates axis scale to 10 dB/DIV.
- ② When the ^{SHIFT} and _{OBW} keys are pressed, the function menu will then be displayed.

```
#OBW
 3dB DOWN
 3dB DOWN LOOP
 NEXT PEAK
 QUIT : OFF
```

Select a function after moving the # mark using the
REFERENCE LEVEL
 and keys.

- ③ Press the ^{MARKER} key to execute the function.

Then, the operation of the OBW starts; when the operation ends, two markers appear as Y-point and X-point as mentioned above, and the OBW is displayed on the upper left of the screen (Figure 4-38).

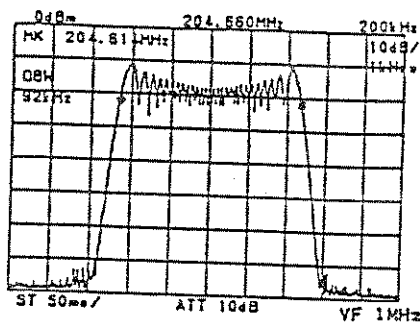

Figure 4-38 Example of OBW Measurement

- ④ When the MKR OFF switch is pressed, the display for the occupied frequency band width is erased and R4131D returns to the normal measuring mode.

When the IF band width is set narrower when measuring the OBW, the measurement can be done with less error. When the MAX mode is used in combination with this, it is also possible to measure the maximum value of the OBW.

4.22 3dB DOWN, 3dB DOWN LOOP, NEXT PEAK Function (Only for R4131D)

(1) 3 dB DOWN

- ① If the marker is off

The spread in frequency between points at which the level has decreased by 3 dB from the peak will be calculated. If the decrease of 3 dB occurs at both a point on the displayed waveform that is lower than that of the peak level in frequency and at a point higher than that of the peak level in frequency, then the differences in frequency as well as in level between those two points will be displayed.

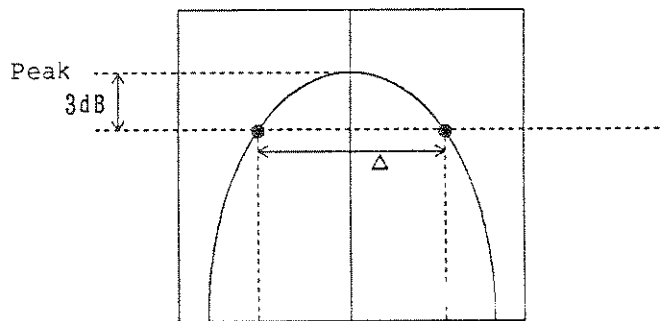

If the decrease of 3 dB occurs only at one point, the differences in frequency as well as in level between that point and the peak point will be displayed.

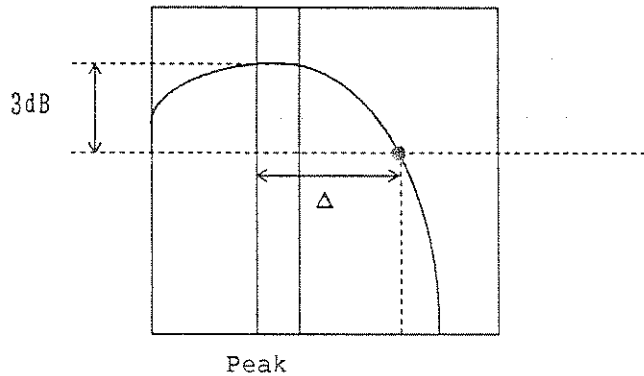

- ② If the marker is already on

The spread in frequency between points at which the level has decreased by 3 dB from the level corresponding to the marker point will be calculated.

If the decrease of 3 dB occurs at both a point on the displayed waveform that is lower than the marker point in frequency and at a point higher than the marker point in frequency, then the differences in frequency as well as in level between those two points will be displayed.

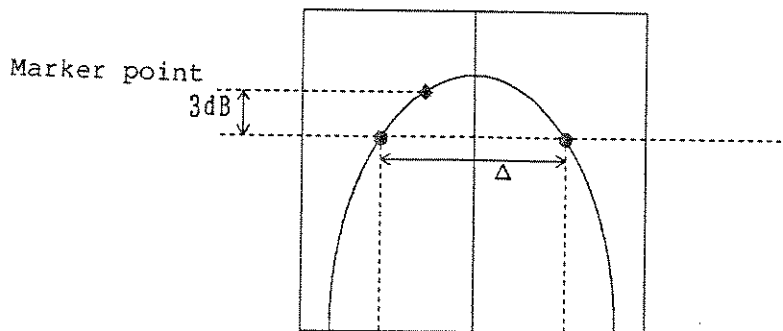

If the decrease of 3 dB occurs only at one of the two points mentioned above, the differences in frequency as well as in level between that point and the marker point will be displayed.

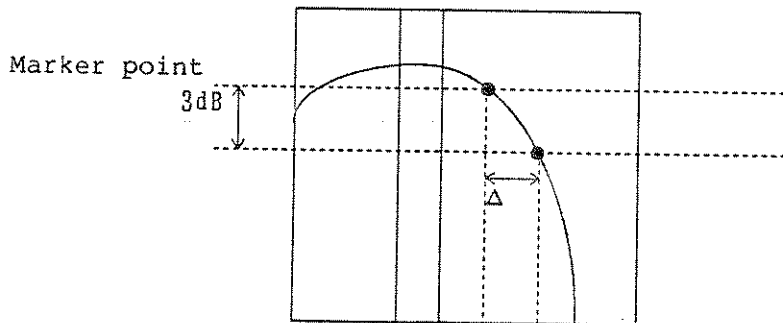

(2) 3 dB DOWN LOOP

The 3 dB DOWN LOOP function is valid only while the TRACE mode remains set for WRITE. This function cannot be used for MAX HOLD.

If this function is selected, the peak level of the waveform will be detected at the end of sweep. Following this, the point(s) on the waveform where the power level decreases by 3 dB from the peak will be detected. As with the 3 dB DOWN function described above, if the decrease of 3 dB occurs at two points (or at one point only), then the differences in frequency as well as in level between those two points (or between that point and the marker point) will be displayed. In this case, operation will be the same, irrespective of the on or off status of the marker.

(3) NEXT PEAK

- ① If the marker is off

The marker will be placed at a position that corresponds to the signal having the second largest level.

- ② If the marker is on

The marker will move to a position that corresponds to the signal having the next larger level to that of the current marker point.

- ③ If the display line is on

A search operation will be performed only on the signal having a level larger than the display line.

(4) Operating procedure

- ① When the ^{SHIFT} and _{OBW} keys are pressed, the function menu will then be displayed.

```
#OBW
3dB DOWN
3dB DOWN LOOP
NEXT PEAK
QUIT : OFF
```

Select a function after moving the # mark using the REFERENCE LEVEL

and keys.

- ② Press the ^{MARKER} key to execute the function.
- ③ Press the _{OFF} key to return to the usual measurement mode.

4.23 Plotter Output

The tube surface data can be plotted using the ADVANTEST manufactured plotter and HP Corp. manufactured 7440 or its equivalent.

Operating procedure

- ① Connect this equipment to the plotter through the GPIB connector.
- ② Then, the screen to be plotted can be stored and kept standing still. It is also possible to sweep it with the single trigger to make it stand still.
- ③ When the ^{SHIFT} and _{PLOT} keys are pressed, the system is made into the PLOTTER mode and the PLOT function selecting screen is displayed on the tube surface (Figure 4-39).

For instance, the # mark moves to either side of ALL or WAVE ONLY each time the _{RPW} key is pressed.

- ④ Move the # mark using the associated keys and select any function. The plot type is selected with the _{HITD} key and the size is selected with the _{SPHIF} key.
- ⑤ To quit from the PLOTTER mode at this point, press the _{PLOT} key.
- ⑥ When the _{DSP LINE} (EXECUTE) key is pressed, the plotting is started.
- ⑦ When the _{LCL} (CANCEL) key is pressed, the plotting can be stopped even halfway.

The PLOT TYPE of each plotter is selected as shown in Table 4-5.

selection	:key
MODE:#ALL	:RBW
WAVE ONLY:	
PLOT TYPE #TR	:AUTO
TR_R	:
HP	:
SIZE #BIG	:FREQ SPAN
MIDDLE	:
SHALL	:
QUIT	:<>NARROW
EXECUTE	:<>WIDE
CANCEL	:LCL

Figure 4-39 PLOT Function Selection Screen

Table 4-5 PLOT TYPE of Each Plotter

PLOT TYPE	Plotter name
HP	R9833, and HP Corp. manufactured 7470 or equivalent

Note: The plot type for R9833 is set to "HP" when they are delivered from the factory, since the HP-GL-1 (HP-GL) was then assumed to be used. When the FP-GL-2 (GP-GL) is used, set the plot type to "TR". The TR_R is for the case where continuous roll paper is used.

When the connection to the plotter is no good or the power is not turned ON, "PLOTTER ERROR" is displayed in the center of the screen. Recheck the connection and setting and then reset with any key and then set the PLOT mode over again.

MEMO 

5. APPLIED MEASURING METHOD

This chapter describes the overall operating method of this equipment through the measuring examples of AM wave and FM wave.

5.1 Measurement of Modulation Frequency and Index of AM Signal

The AM signal wave when expressed in the time axis becomes as shown in Figure 5-1 (a) and the modulation index m (%) can be obtained from the maximum value and minimum value of its waveform.

When expressed in the frequency axis, the AM signal wave becomes as shown in Figure 5-1 (b) and the modulation index m (%) can be obtained by measuring the frequency level of the carrier and that of the sideband.

When the modulation frequency is low and its spectrum cannot be separated completely, the signal wave is observed in the ZERO SPAN mode. When the modulation frequency is high, the modulation index is generally obtained from the difference between the frequency of the upper sideband and that of the carrier in the FREQUENCY SPAN mode. When the modulation is small and the signal wave is difficult to see even though the modulation frequency is low, observe it in the FREQUENCY SPAN mode. The measurement precision rises when the signal wave is observed in the LINEAR mode when the modulation index is more than 10%, or in the LOG mode when the modulation index is less than 10%.

The following describes the measuring procedure for when the modulation frequency is low and when it is high.

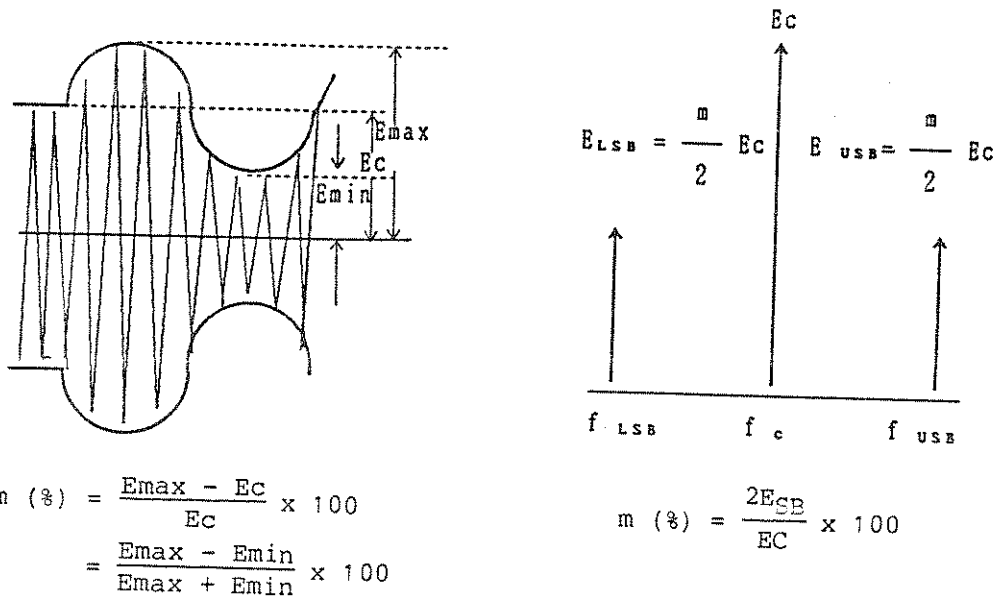

Figure 5-1 AM Signal Wave

5.1.1 Measurement of AM Wave When the Modulation Frequency Is Low and Modulation Index Is Large

Operating procedure

- ① Connect the AM transmitter output to the INPUT connector of this equipment by making it pass through the external attenuator when necessary (Figure 5-2).

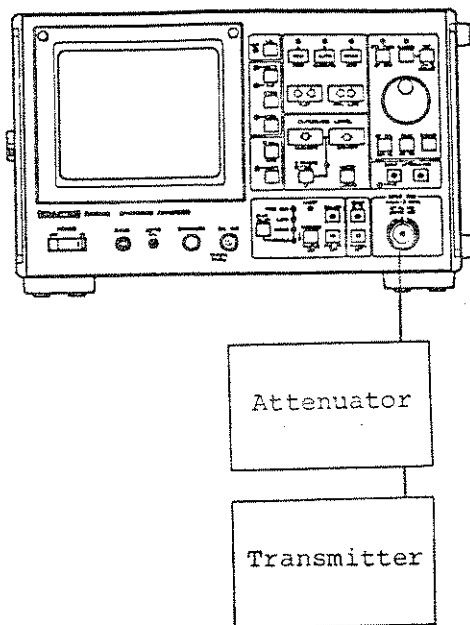



Figure 5-2 Set-up in Measurement of Modulation Wave

- ② Set the center frequency to the frequency of the signal to be measured.

Press the key and turn the  to set the center frequency to 903 MHz (Figure 5-3).

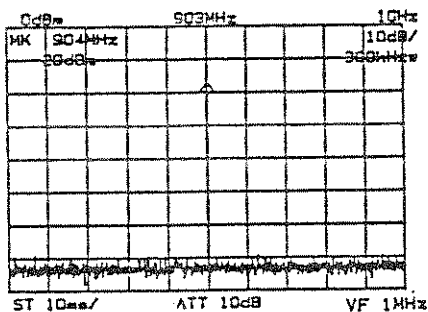



Figure 5-3 Setting the Center Frequency to the Frequency of the Measured Signal

③ Press the SPAN, and RBW, keys and set the resolution band width to more than three times the modulation frequency.

④ Press the MARKER and set the marker to the peak of the

measured signal with the .

(When the PEAK key is pressed, the marker is automatically set to the peak of the measured signal.)

⑤ Press the REFERENCE LEVEL key and set the marker (the peak of the measured signal) to the reference level.

⑥ Press the SHIFT, COARSE FINE key and set the ordinates axis scale to LINEAR (Figure 5-4).

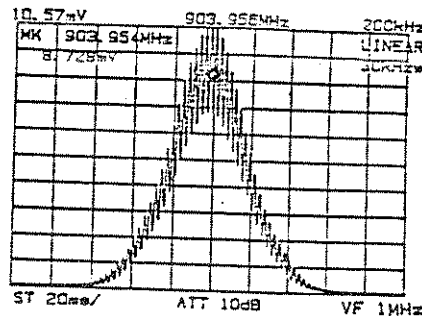

Figure 5-4 Setting the Ordinates Axis Scale to LINEAR

⑦ Press the SHIFT, ZERO key and enter the system into the ZERO SPAN mode.

⑧ Press the SHIFT, SAMPLE DET key and enter the system into the SAMPLE mode.

R4131 SERIES
SPECTRUM ANALYZER
INSTRUCTION MANUAL

5.1 Measurement of Modulation Frequency
and Index of AM Signal

- ⑨ Press the CTR FREQ key and turn the **Data knob** to adjust the signal level to make it the maximum.

- ⑩ Press the **TRIGGER** key and set the trigger mode to VIDEO.

- ⑪ Press the **SAMPLE DET** key and set the sweep time to a value that can be observed easily.

- ⑫ Press the **MARKER** and turn the **Data knob** to set the marker to the peak of the modulation signal. Keep recording the time indication of the marker at this time (Figure 5-5).

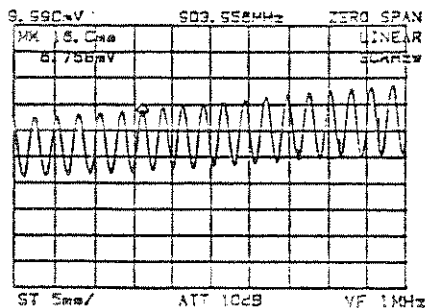

Figure 5-5 Reading the Time Display of Marker

- ⑬ Move the marker to the next peak and obtain the difference $T(s)$ between the time indication of that marker and the time indication in step ⑫. In this example, it can be obtained as $18.6 - 16.0 = 2.6$ (ms) (Figure 5-6).

Frequency f_m of the modulation signal becomes as follows in this example:

$$f_m = \frac{1}{T(s)}$$

$$f_m = \frac{1}{2.6 \text{ (ms)}} = 384 \text{ (Hz)}$$

5.1 Measurement of Modulation Frequency
and Index of AM Signal

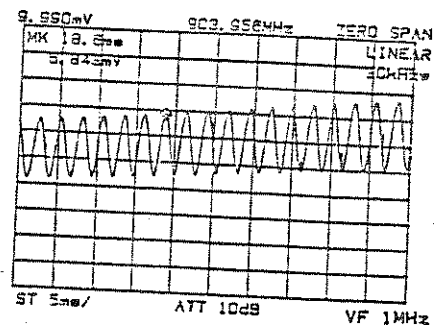

Figure 5-6 Reading the Difference from the Time Indication of the Adjacent Peak

- ⑭ Read the marker level Emax (Figure 5-7).

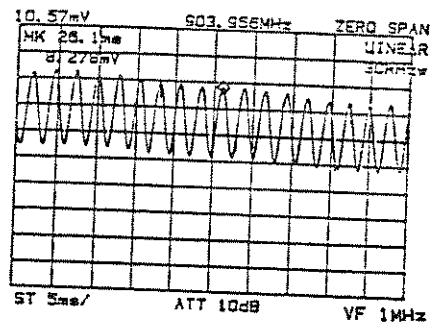

Figure 5-7 Reading the Emax

- ⑮ Set the marker to the minimum value of the waveform and read the level Emin (Figure 5-8).

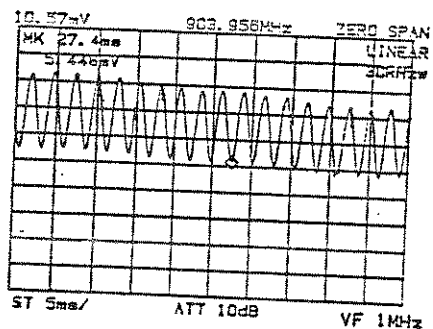

Figure 5-8 Reading the Emin

R4131 SERIES
SPECTRUM ANALYZER
INSTRUCTION MANUAL

5.1 Measurement of Modulation Frequency
and Index of AM Signal

- ⑫ The modulation index m (%) becomes as follows in this example:

$$m = \frac{E_{max} - E_{min}}{E_{max} + E_{min}} \times 100 (\%)$$

$$m = \frac{8.278 - 5.448}{8.278 + 5.448} \times 100 = \frac{2.830}{13.726} \times 100 = 20.6 (\%)$$

5.1.2 Measurement of AM Wave When Modulation Frequency is High and Modulation Index is Small

Operating procedure

- ① Connect the AM transmitter output to the INPUT connector of this equipment by making it pass through the external attenuator when necessary as shown in Figure 5-2.
- ② Set the center frequency to the frequency of the carrier.



- ③ Set the frequency span to less than 10 times the modulation frequency.



- ④ Set the marker to the peak of the carrier and keep recording that frequency (Figure 5-9).

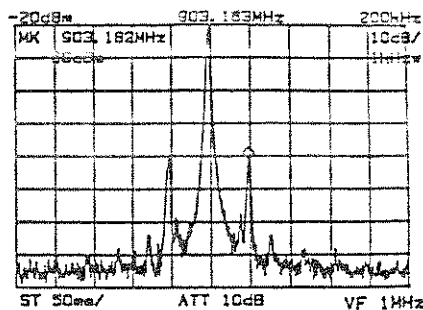
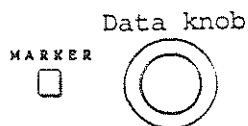

Figure 5-9 Measurement of AM Wave When Modulation Frequency is High and Modulation Index is Small

- ⑤ Move the marker to the peak of the modulation signal spectrum.

Data knob



- ⑥ Compare the marker frequency and level at that time with the frequency kept recorded in step ④; then the modulation frequency and modulation index can be obtained from the difference between the frequency and level according to the following equation:

f_m = Difference from the marker frequency indicated value

$$m = \text{Log}^{-1} \frac{(E_{SB} - E_C + 6)}{20} \times 100 (\%)$$

$$= \text{Log}^{-1} \frac{\left(\begin{array}{l} \text{Marker level indicated} \\ \text{value difference} \end{array} + 6 \right)}{20} \times 100 (\%)$$

In the example of Figure 5-9, $f_m = 20$ kHz and $m = 2\%$.

Figure 5-10 shows the relationship between the value of (Sideband level E_{SB} - carrier level E_C) and modulation index m (%).

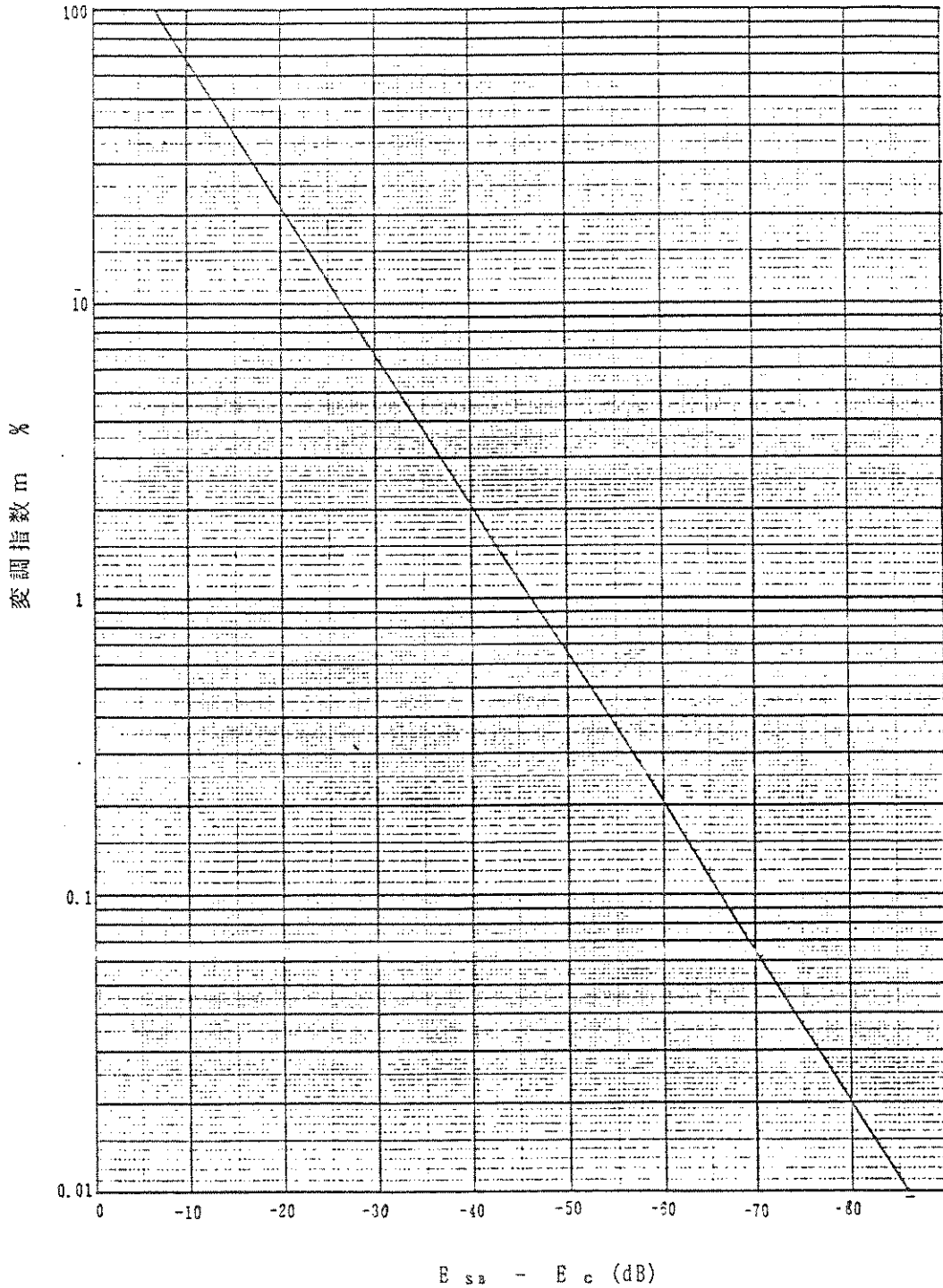

Figure 5-10 Relationship Between the Value of (Sideband Level E_{SB} - Carrier Level E_C) and Modulation Index m (%)

5.2 Measurement of FM Wave

When observing the FM wave, it is possible to obtain modulation frequency f_m , modulation index m , and peak deviation Δf_{peak} . When the modulation frequency is low, set the ordinates axis to the ZERO SPAN, make it operate as a fixed tuning receiver, demodulate the frequency using the slope of the IF filter, and measure it on the time axis.

When the modulation frequency is high, measure it on the frequency axis and obtain the modulation frequency from the frequency of the sideband. When the modulation index m is small (when it is less than approx. 0.8), obtain it from the relationship between the carrier level and the first sideband level.

The following describes this measurement example in either case.

5.2.1 Measurement of FM Wave When Modulation Frequency Is Low

Operating procedure

- ① Connect the FM transmitter output to the INPUT connector of this equipment by making it pass through the external attenuator when necessary, as shown in Figure 5-2.
- ② Set the carrier of the signal so that it becomes the center frequency, and make it the span suitable for analyzing the spectrum.



- ③ Set the marker to the peak of the signal.

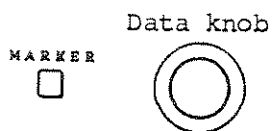

- ④ Set the marker level to the reference level.

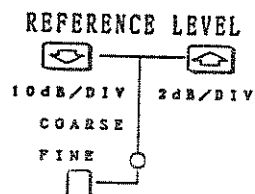

- ⑤ Lower the reference level (Figure 5-11).

REFERENCE LEVEL



10dB/DIV

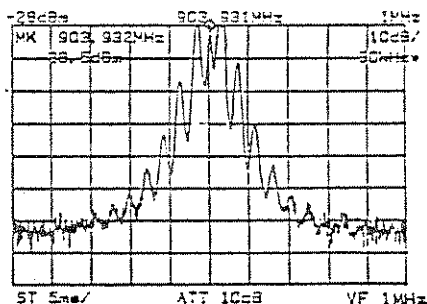

Figure 5-11 Measurement of FM Wave When Modulation Frequency Is Low

- ⑥ Make the system into the ZERO SPAN mode.

SHIFT



ZERO

- ⑦ Change the center frequency so that the demodulation wave becomes the center of the screen.

CTR FREQ



Data knob

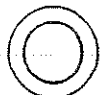

- ⑧ Make the resolution band width to more than three times the modulation frequency so that the demodulation wave can be seen easily.



RBW



OR



PLOT DISPLAY LINE

- ⑨ Set the trigger mode to VIDEO.

TRIGGER



- ⑩ Select a sweep time for easily seeing the demodulation wave.

TIME/DIV
 or
 POS PK
 DET

- ⑪ Put the marker on the peak of the demodulation wave and keep recording its time indication (Figure 5-13).

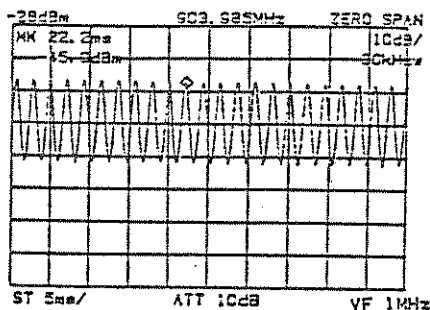

Figure 5-12 Putting the Marker on the Peak of Demodulation Wave and Reading Its Time Indication

- ⑫ Move the marker to the adjacent peak and read its time indication (Figure 5-13).



From the time interval $T(s)$ of the peak of the demodulation wave, the modulation frequency (f_m) can be obtained as follows:

$$f_m = \frac{1}{T(s)}$$

Since $T(s) = 2.1$ (ms) in this example, the modulation frequency (f_m) can be obtained as follows:

$$f_m = \frac{1}{2.1 \text{ (ms)}} \approx 476 \text{ (Hz)}$$

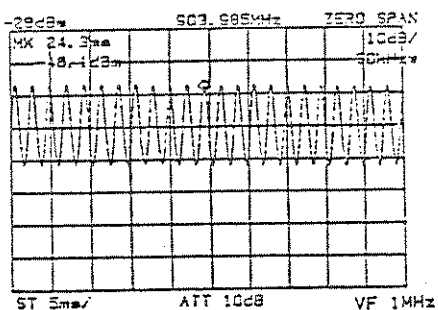
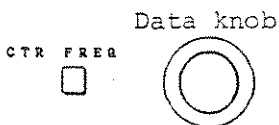

Figure 5-13 Obtaining the Time Interval T(s) of Demodulation Wave

5.2.2 Measurement of FM Wave for High Modulation Frequency

Operating procedure

- ① Connect the FM transmitter output to the INPUT connector of this equipment by making it pass through the external attenuator when necessary, as shown in Figure 5-2.
- ② Set the carrier frequency to the center frequency.



- ③ Set the frequency span to a value lower than 10 times of the modulation frequency.



- ④ Put the marker on the peak of the carrier and keep recording the marker frequency at this time (Figure 5-14).



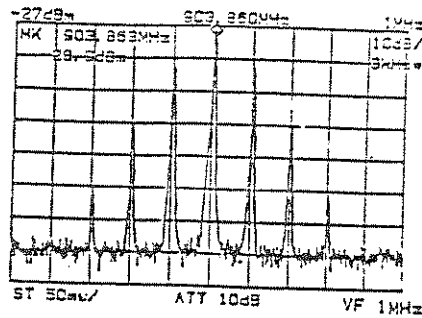

Figure 5-14 Measurement of FM Wave When Modulation Frequency Is High

- ⑤ Move the marker to the adjacent peak and read the indication of the marker frequency (Figure 5-15).

Data knob

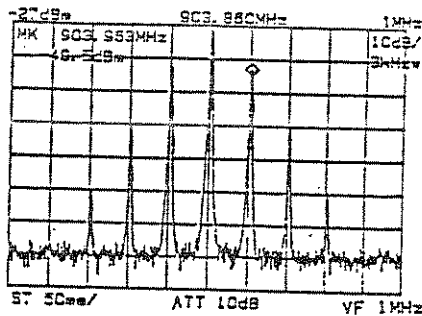

Figure 5-15 Reading the Modulation Frequency from the Marker Display

- ⑥ The difference from the frequency indication of the marker becomes the modulation frequency (fm).

For this example, the modulation frequency can be obtained as follows:

$$f_m = 903.963 - 903.863 = 100 \text{ (kHz)}$$

5.2.3 Measurement of Peak Deviation (Δf_{peak}) of FM Wave

Operating procedure

- ① Connect the FM transmitter output to the INPUT connector of this equipment by making it pass through the external attenuator when necessary, as shown in Figure 5-2.
- ② Set the center frequency to the carrier frequency.



- ③ Set the frequency span to a value enabling easy measurement according to the peak deviation.

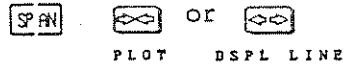

- ④ Set the resolution band width to a value including the principal sideband (more than five times the modulation frequency).

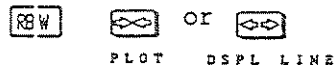

- ⑤ Figure 5-16 shows a case where Δf_{peak} is small and Figure 5-17 shows a case where it is large. Measure the Δf_{peak} from the waveform.

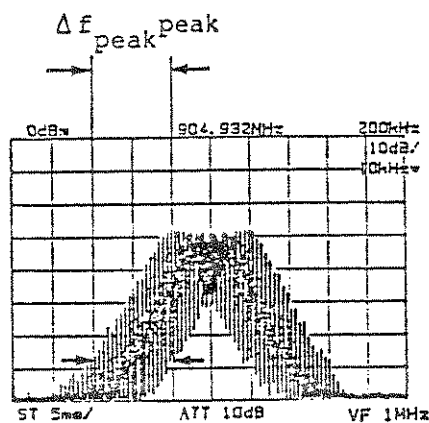

Figure 5-16 Waveform When Δf_{peak} Is Small

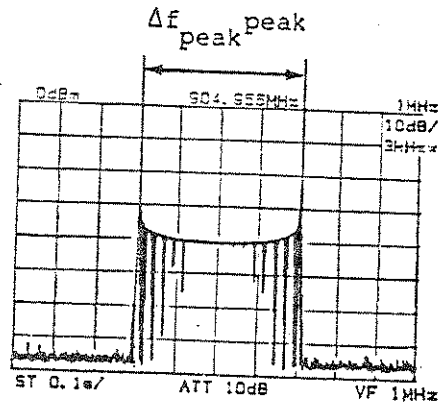

Figure 5-17 Waveform When Δf_{peak} Is Large

Δf_{peak} and modulation index m can be obtained from the following equation:

$$\Delta f_{\text{peak}} = \frac{1}{2} \times \Delta f_{\text{peak peak}}$$

$$m = \frac{\Delta f_{\text{peak}}}{f_m}$$

For the two figures, the measurement is carried out as follows, respectively:

- Figure 5-16: When Δf_{peak} is small

$f_m = 2 \text{ kHz}$, and Δf_{peak} is read as approx. 40 kHz:

$$\Delta f_{\text{peak}} = \frac{1}{2} \times 40 \text{ (kHz)}$$

$$m = \frac{20 \text{ (kHz)}}{2 \text{ (kHz)}} = 10$$

- Figure 5-17: When Δf_{peak} is large

$f_m = 400 \text{ Hz}$, and Δf_{peak} is read as approx. 400 kHz:

$$\Delta f_{\text{peak}} = \frac{1}{2} \times 400 \text{ (kHz)}$$

$$m = \frac{200 \text{ (kHz)}}{400 \text{ (Hz)}} = 500$$

5.2.4 How to Obtain Modulation Index m when FM Modulation Index m Is Small

When the modulation index m of the FM wave is less than approx. 0.8, the following equation can be formed:

$$m = \frac{2E_{\text{SB}}}{E_{\text{C}}}$$

Where,

E_{SB} : 1st sideband level

E_{C} : Carrier level

Operating procedure

- ① Connect the FM transmitter output to the INPUT connector of this equipment by making it pass through the external attenuator when necessary, as shown in Figure 5-2.
- ② Set the center frequency and frequency span so that the carrier can be observed easily.

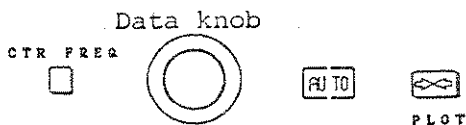

- ③ Set the carrier level to the reference level as shown in Figure 5-18.

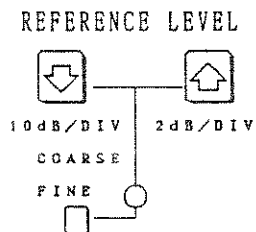

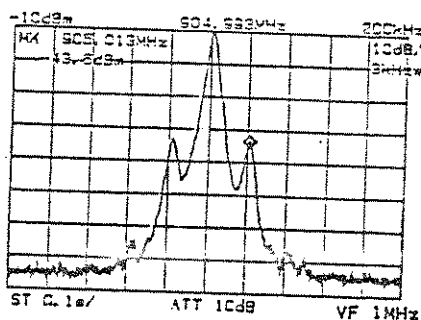

Figure 5-18 How to Obtain Modulation Index m When FM Modulation Index m is Small

- ④ Read and keep recording the carrier frequency f_C from the display of the center frequency and also the carrier level E_C from the display of the reference level.

In the case of this example, they become as follows:

$$f_C = 904.993 \text{ MHz}, E_C = -10 \text{ dBm}$$

- ⑤ Set the marker to the first sideband and read its frequency f_{SB} and level E_{SB} from the display of the marker.

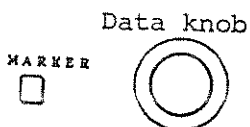

For this example, they become as follows:

$$f_{SB} = 905.103 \text{ MHz}, E_{SB} = -43.6 \text{ dBm}$$

- ⑥ The FM modulation index m can be obtained from the following equation:

$$m = 2 \times \frac{E_{SB}}{E_C} = \text{Log}^{-1} \frac{E_{SB} - E_C + 6}{20}$$

For this example, it becomes as follows:

$$m = \text{Log}^{-1} \frac{-43.6 - (-10) + 6}{20} = \text{Log}^{-1} (-1.38) \approx 0.04$$

- ⑦ The modulation frequency f_m can be obtained from
 $f_m = |f_{SB} - f_C|$.

For this example, it becomes as follows:

$$f_m = 20 \text{ kHz}$$

- ⑧ The frequency deviation Δf_{peak} can be obtained from $\Delta f_{\text{peak}} = m \times f_m$.

For this example, it becomes as follows:

$$\Delta f_{\text{peak}} = 0.04 \times 20 \text{ (kHz)} = 800 \text{ Hz}$$

MEMO



6. GPIB CONNECTION AND PROGRAMMING

This equipment features the measurement bus GPIB (General Purpose Interface Bus), which conforms the IEEE Standards 488-1978, as standard equipment to enable full remote control by an external controller.

6.1 Outline of GPIB

The GPIB is an interface system which can connect a measuring instrument to a controller and its peripheral equipment, etc. with a simple cable (bus line). Compared with conventional interfacing methods, it has excellent expandability, is easy to use, and is compatible with products of other companies electrically, mechanically, and functionally. This allows versatile configuration from a simple system to a high-level automatic measuring system with one bus cable.

In the GPIB system, it is first necessary to preset an "address" of separate component equipment connected to its bus line. These equipment can perform one or two of three roles -- controller, talker (speaking party), and listener (listening party).

During the system operation, only one talker can send data to the bus line and a multiple listeners can receive the data. The controller specifies the address of a talker and listener to transfer data from the talker to listener, or the controller itself (a talker in this case) sets measuring conditions, etc., of the listener.

For data transfer between equipment, the GPIB system uses eight data lines of bit parallel and byte serial types and also transmits data in both directions asynchronously. Being an asynchronous system, high speed devices and low speed ones can be connected to each other.

The data (messages) exchanged between devices consists of measuring data, measuring conditions (programs), and various commands. The system uses the ASCII code.

In addition to the above eight data lines, the GPIB provides three handshaking lines to control sending and receiving asynchronous data, and five control lines to control the flow of data on bus lines.

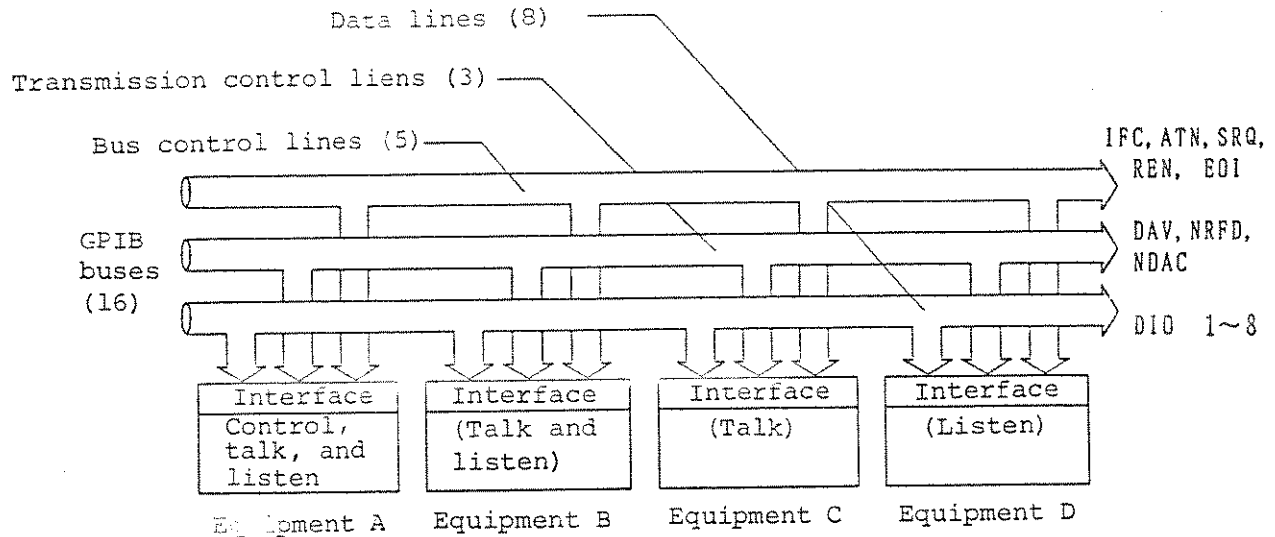

Figure 6-1 Outline of GPIB

● The following signals are used for handshaking lines:

- DVA (Data Valid) : This is a signal to indicate that the data is valid.
- NRFD (Not Ready For Data): This is a signal to indicate that the data is ready for receiving.
- NDAC (Not Data Accepted) : This is a signal to indicate that the data reception is completed.

● The following signals are used for control lines:

- ATN (Attention) : This is a signal used to distinguish that the signal on the data line is either address or command, or some other data.
- IFC (Interface Clear) : This is a signal to clear the interface.
- EQI (End or Identify) : This is a signal used when the data transfer ends.
- SRQ (Service Request) : This is a signal used to request a service from any equipment to the controller.
- REN (Remote Enable) : This is a signal used when remote programmable equipment is controlled remotely.

6.2 Standards

6.2.1 GPIB Specifications

Conformed standards : IEEE Standards 488-1978
 Code used : ASCII code, or binary code for packed format
 Logical level : Logical 0 "High" status More than +2.4 V
 Logical 1 "Low" status Less than +0.4 V
 Signal line termination: 16 bus lines are terminated as shown below:

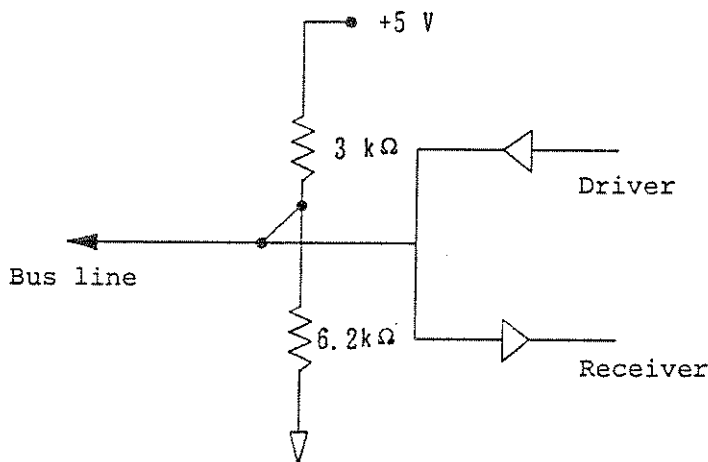

Figure 6-2 Signal Line Termination

Driver specification : Open collector type
 Output voltage under the "Low" status
 ... 48 mA at +0.4 V or less
 Output voltage under the "High" status
 ... -5.2 mA at +2.4 V or more
 Receiver specification: "Low" status at +0.6 V or less
 "High" status at +2.0 V or more
 Length of bus cable : The length of each cable should be less than
 4 m and the total length of all bus cables
 (the number of equipment connected to buses x
 2) should not exceed 20 m.
 Address specification : 31 types of TALK address/LISTEN addresses can
 be set freely using the ADDRESS switch on the
 rear panel.
 After changing over to the ADDRESS switch,
 turn OFF the POWER SW once and then ON again.
 Connector : 24-pin GPIB connector

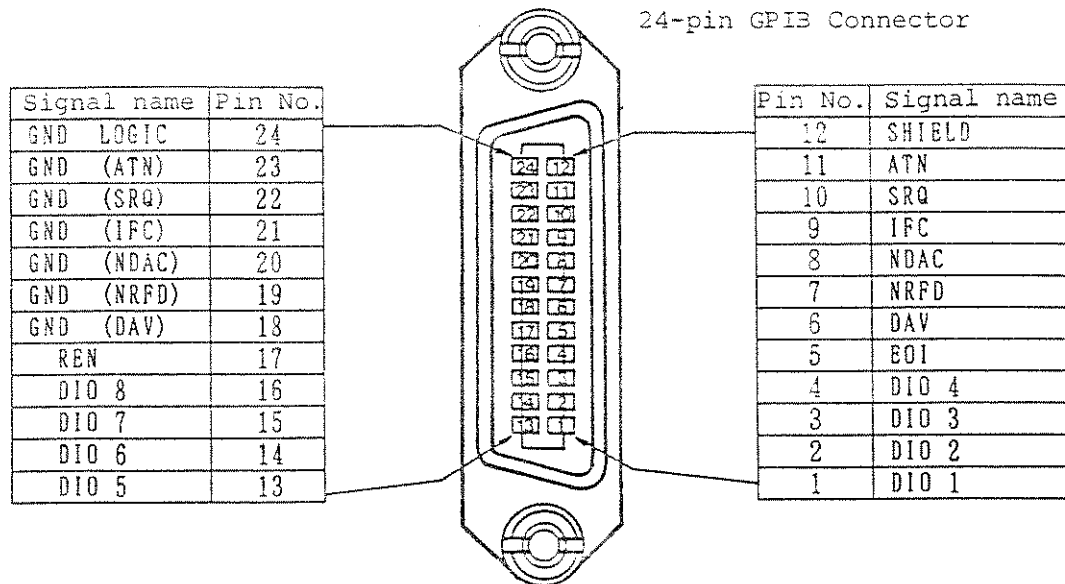

Figure 6-3 GPIB Connector Pins Assignment Diagram

6.2.2 Interface Function

Table 6-1 Interface Function

Code	Function and explanation
SH1	Source handshaking function
AH1	Acceptor handshaking function
T6	Basic talker function, serial polling function, and talker releasing function by listener specification
L4	Basic listener function and listener releasing function by talker specification
SR1	Service requesting function
RL1	Remote function
PP0	No parallel function provided
DC1	Device clearing function provided
DT1	Device triggering function provided
C0	No controlling function provided. However, the controller function is enabled when the plotter is used.
E1	Open collector and bus driver used. However, E2 is used for EOI and DAV (three-state bus driver used).

6.3 GPIB Handling Method

6.3.1 For Connection to Component Devices

Since the GPIB system is composed of multiple devices, prepare the entire system while paying attention to the following points especially.

- (1) Before connection, check the condition and operation of each device according to the operation manual for R4131, controller and other peripheral devices, etc.
- (2) Do not make any bus cable connected to each measuring instrument and controller, etc., unnecessarily long. The length of each cable should be less than 4 m and the total length of all bus cables (the number of devices connected to buses x 2) should not exceed 20 m. ADVANTEST provides standard bus cables as shown in Table 6-2.

Table 6-2 Standard Bus Cables (To Be Purchased Separately)

Length	Name
0.5 m	408JE-1P5
1 m	408JE-101
2 m	408JE-102
4 m	408JE-104

- (3) Bus cable connectors are of a piggy back type. Male and female connectors are provided for one connector, which can be used one over the other. Do not pile up three or more connectors when connecting cables. Also, be sure to screw connectors tightly with setscrews.
- (4) Before turning ON the power of the devices connected to the bus lines, check their power supply conditions, grounding status, and setting conditions, too, when necessary. Be sure to set the power of each component unit to ON. If any of them is not set to ON, the overall operation cannot be guaranteed.

3.2 Setting of ADDRESS Switch

The rear panel of this equipment has a ADDRESS switch (Figure 6-4) used to set addresses on the GPIB. By setting bits 1 (the right end) to 5 to 0 or 1, addresses can be set from 0 to 30.

Set the ADDRESS switch before turning on the power.

The relationship between this ADDRESS switch and GPIB addresses is shown in Table 6-3.

Table 6-3 Setting of ADDRESS Switch

GPIB address	Bit					GPIB address	Bit					GPIB address	Bit				
	5	4	3	2	1		5	4	3	2	1		5	4	3	2	1
0	0	0	0	0	0	11	0	1	0	1	1	21	1	0	1	0	1
1	0	0	0	0	1	12	0	1	1	0	0	22	1	0	1	1	0
2	0	0	0	1	0	13	0	1	1	0	1	23	1	0	1	1	1
3	0	0	0	1	1	14	0	1	1	1	0	24	1	1	0	0	0
4	0	0	1	0	0	15	0	1	1	1	1	25	1	1	0	0	1
5	0	0	1	0	1	16	1	0	0	0	0	26	1	1	0	1	0
6	0	0	1	1	0	17	1	0	0	0	1	27	1	1	0	1	1
7	0	0	1	1	1	18	1	0	0	1	0	28	1	1	1	0	0
8	0	1	0	0	0	19	1	0	0	1	1	29	1	1	1	0	1
9	0	1	0	0	1	20	1	0	1	0	0	30	1	1	1	1	0
10	0	1	0	1	0												

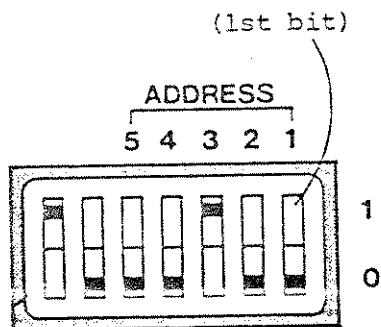
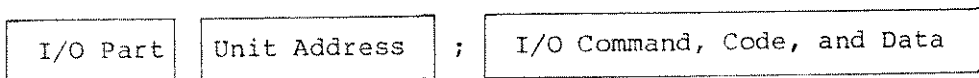

Figure 6-4 ADDRESS Switch

6.3.3 Programming

Programming for GPIB covers the sending of GPIB command codes and data to equipments to be connected, reading of data from devices, execution of bus commands, and I/O commands (e.g., serial polling, etc.). The arithmetic operation and others shall conform to the program generating procedure in the controller.

The format of GPIB commands to any equipments and I/O statements of data have the configuration as follows:



Setting of Each Function

This equipment may be put under remote control for all functions using the GPIB controller.

This section describes the setting of each function of this equipment referring to program examples using a desk-top computer, HP Corporation's HP200/300 series.

Program examples are all assumed to be set from their initial status.

Example 6-1: Setting the Center Frequency to 500 MHz and
Frequency Span to 2 MHz

HP200, 300 Series

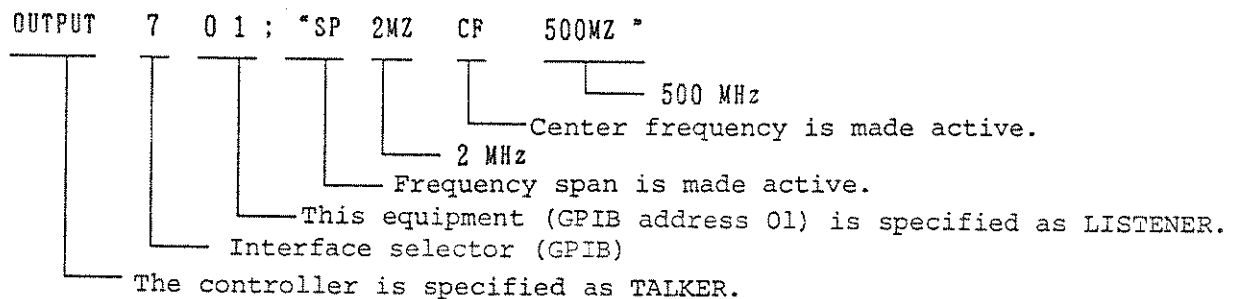

When programmed and executed as above, this equipment is set to 500 MHz in center frequency and 2 MHz in frequency span.

CF, SP, and MZ, etc. in the program are all GPIB commands to control this equipment.

Since these commands correspond to keys of this equipment, the programming can be made in the order of pressing keys on the panel.

See Section 6.9 for a list of GPIB codes.

6.4.1 Setting of Center Frequency

There are two methods available for the setting of center frequency using the GPIB.

One is to make the center frequency increase (or decrease) step by step using the data knob setting command, and, while reading its value sequentially, it is repeated until the frequency is set to the target value. The other method is to set the value of frequency directly.

- (1) When the Center Frequency Is Set Using the Command for Setting the TUNING Knob

Example 6-2: Setting the Center Frequency to 1 GHz

HP200/300 Series

```

10 OUTPUT 701; "SP 1GZ"
20 OUTPUT 701; "OPCF"
30 ENTER 701;F
40 IF F=1E9 THEN 70
50 OUTPUT 701; "CD"
60 GOTO 30
70 IF F=1E9 THEN 100
80 OUTPUT 701; "CU"
90 GOTO 30
100 END

```

Line No.	Meaning
10	Sets the frequency span to 1 GHz.
20	Instructs this equipment to output the value of the center frequency. See the OP Command in 6.5.1.
30	Reads the value of the center frequency.
40	Branches to line No. 70 when the read data is smaller than or equal to 1×10^9 (Hz).
50	Sends the command to turn the data knob counterclockwise for 1 step of COARSE.
60	Returns to line No. 30.
70	Branches to line No. 100 when the read data is equal to 1×10^9 (Hz).
80	Sends the command to turn the data knob clockwise for 1 step of COARSE.
90	Returns to line No. 30.
100	End of program

Note: Note that the set resolution of the center frequency becomes coarse and the center frequency cannot be set to the desired value when the frequency span is wide.

(2) When the Value of Center Frequency is Set Directly

Example 6-3: Setting the Center Frequency to 1 GHz Directly

HP200/300 Series

```
10 OUTPUT 701: "CF1GZ"  
20 END
```

Line No.	Meaning
10	Sets the center frequency to 1 GHz.
20	End of program

6.4.2 Setting of Frequency Span

There are two methods available for the setting of the frequency span using the GPIB. One is to make the frequency span wider or narrower in 1-2-5 steps using the command (NR and WD) corresponding to the key on the front panel. The other method is to set the value of the frequency span directly.

(1) When Using the Command Corresponding to the Key on Front Panel



Example 6-4: Setting the Frequency Span to 20 MHz

HP200/300 Series

```

10 OUTPUT 701; "OPSP"
20 ENTER 701;S
30 IF S<=20E6 THEN 60
40 OUTPUT 701; "NR"
50 GOTO 20
60 IF S=20E6 THEN 90
70 OUTPUT 701; "WD"
80 GOTO 20
90 END

```

Line No.	Meaning
10	Instructs this equipment to output the set value of frequency span. Sends the command SP of the SPAN key to light the LED on the key.
20	Reads the data (the value of the frequency span).
30	Branches to line No. 60 when the read data is smaller than or equal to 20×10^6 (Hz).
40	Sends the command for  of this equipment to make the frequency span narrower by 1 step.
50	Returns to line No. 20.
60	Branches to line No. 90 when the read data is equal to 20×10^6 (Hz).
70	Sends the command for  of this equipment to widen the frequency span by 1 step.
80	Returns to line No. 20.
90	End of program

(2) When the Value of Frequency Span Is Set Directly

Example 6-5: Setting the Frequency Span to 20 MHz Directly

HP200/300 Series

10 OUTPUT 701; "SP20MZ"
20 END

Line No.	Meaning
10	Sets the frequency span to 20 MHz.
20	End of program

When the frequency span is set directly, do it using the codes given in the table below.

Frequency Span Set Value Codes

Code	SPAN	Code	SPAN	Code	SPAN
SP50KZ	50 kHz				
SP100KZ	100 kHz	SP10MZ	10 MHz	SP1GZ	1 GHz
SP200KZ	200 kHz	SP20MZ	20 MHz	SP2GZ	2 GHz
SP500KZ	500 kHz	SP50MZ	50 MHz	SP4GZ	4 GHz
SP1MZ	1 MHz	SP100MZ	100 MHz	ZS	ZEROSPAN
SP2MZ	2 MHz	SP200MZ	200 MHz		
SP5MZ	5 MHz	SP500MZ	500 MHz		

6.4.3 Setting of Reference Level

There are two methods available for setting the reference level using the GPIB.

One is to set the reference level up and down using the command (LU, LD, or FC) corresponding to the key on the front panel to set it to the desired value. The other method is to set the value of the reference level directly.

Note that the set range of the reference level narrows according to the set value of the input attenuator.

R4131 SERIES
SPECTRUM ANALYZER
INSTRUCTION MANUAL

6.4 Setting of Each Function

(1) When Using the Command Corresponding to the Key on Front Panel



Example 6-6: Setting the Reference Level to -30 dBm

HP200/300 Series

```

10 OUTPUT 701; "OM"
20 ENTER 701 USING "#,B";A1,A2,A3,A4,A5,A6,A7
30 IF A4=1 THEN 50
40 OUTPUT 701; "FC"
50 OUTPUT 701; "OPRL"
60 ENTER 701; L
70 IF L<=-30 THEN 100
80 OUTPUT 701; "LD"
90 GOTO 60
100 IF L=-30 THEN 130
110 OUTPUT 701; "LU"
120 GOTO 60
130 END

```

Line No.	Meaning
10	Instructs the equipment to output the mode string.
20	Reads the mode string.
30	Incorporates a numeric value which indicates the setting COARSE or FINE that the reference level setting switch sets to the numerical variable A4. (COARSE = 0, FINE = 1) Branches to line No. 50.
40	Sends the COARSE/FINE SELECTION key command.
50	Instructs this equipment to output the set value of the reference level.
60	Reads the data.
70	Branches to line No. 100 when the read data is less than or equal to -30 (dBm).
80	Sends the command of the REFERENCE LEVEL DOWN key  to lower the reference level by 1 step.
90	Returns to line No. 60.
100	Branches to line No. 130 when the read data is equal to -30 (dBm).
110	Sends the command of the REFERENCE LEVEL UP key  to raise the reference level by 1 step.
120	Returns to line No. 60.
130	End of program

Note: See the mode string in 6.5.3.

(2) When the Value of the Reference Level Is Set Directly

Example 6-7: Setting the Reference Level to -30 dBm Directly

HP200/300 Series

```
10 OUTPUT 701: "RL-30DM"
20 END
```

Line No.	Meaning
10	Sets the reference level to -30 dBm.
20	End of program

6.4.4 Setting of Marker

There are two methods available for setting the marker.

One is to increase or decrease the marker frequency step by step using the command for the data knob setting, and while reading its value sequentially, this is repeated until the marker is set to the desired value. The other method is to set the value of the marker frequency directly.

(1) When Using the Command Corresponding to the Data Knob

Example 6-8: Setting the Marker Frequency to 1 GHz

HP200/300 Series

```
10 OUTPUT 701; "M1"
20 OUTPUT 701; "OPMF"
30 ENTER 701;M
40 IF M<=1E9 THEN 70
50 OUTPUT 701; "FD"
60 GOTO 30
70 IF M=1E9 THEN 100
80 OUTPUT 701; "FU"
90 GOTO 30
100 END
```

R4131 SERIES
SPECTRUM ANALYZER
INSTRUCTION MANUAL

6.4 Setting of Each Function

Line No.	Meaning
10	Displays the marker.
20	Instructs this equipment to output the value of the marker frequency.
30	Reads the value of the marker frequency.
40	Branches to line No. 70 when the read data is smaller than or equal to 1×10^9 (Hz).
50	Sends the command to turn the data knob counterclockwise for 1 step of FINE.
60	Returns to line No. 30.
70	Branches to line No. 100 when the read data is equal to 1×10^9 (Hz).
80	Sends the command to turn the data knob clockwise for 1 step of FINE.
90	Returns to line No. 30.
100	End of program

(2) When the Value of Marker Frequency Is Set Directly

Example 6-9: Setting the Marker Frequency to 1 GHz Directly

HP200/300 Series

```
10 OUTPUT 701; "MK1GZ"
20 END
```

Line No.	Meaning
10	Sets the marker frequency to 1 GHz.
20	End of program

6.4.6 Setting of VIDEO FiLTeR Band Width

There are two methods available for setting the VIDEO FiLTeR band width using the GPIB. One is to set it by making the VIDEO FiLTeR band width narrower or wider step by step using the command (VU or VD) corresponding to the key on the front panel. The other method is to directly set the value of VIDEO FiLTeR band width.

- (1) When Using the Command Corresponding to the Key



Example 6-13: Setting the VIDEO FiLTeR band width to 100 Hz

HP200/300 Series

```

10 OUTPUT 701; "OPVF"
20 ENTER 701;V
30 IF V<=1E2 THEN 60
40 OUTPUT 701; "VD"
50 GOTO 20
60 IF V=1E2 THEN 90
70 OUTPUT 701; "VU"
80 GOTO 20
90 END

```

Line No.	Meaning
10	Instructs this equipment to output the value of VIDEO FiLTeR band width.
20	Reads the data.
30	Branches to line No. 60 when the read data is smaller than or equal to 1×10^2 (Hz).
40	Sends the VIDEO FILTER DOWN key  command to lower the set value of VIDEO FiLTeR band width by 1 step.
50	Returns to line No. 20.
60	Branches to line No. 90 when the read data is equal to 1×10^2 (Hz).
70	Sends the VIDEO FILTER UP key  command to raise the set value of VIDEO FiLTeR band width by 1 step.
80	Returns to line No. 20.
90	End of program

(2) When the Value of VIDEO FiLTeR Band Width Is Set Directly

Example 6-14: Setting VIDEO FiLTeR band width to 100 Hz Directly

HP200/300 Series

```
10 OUTPUT 701; "VF 100HZ"
20 END
```

Line No.	Meaning
10	Sets the VIDEO FiLTeR band width to 100 Hz.
20	End of program

When the value of VIDEO FiLTeR band width directly, do it using the codes shown in the table below.

VIDEO FiLTeR Band Width Set Value Codes

Code	Value of VIDEO FiLTeR Band Width
VF10Hz	10 Hz
VF100Hz	100 Hz
VF1KZ	1 kHz
VF10KZ	10 kHz
VF100KZ	100 kHz
VF300KZ	300 kHz
VF1MZ	1 MHz

6.4.7 Setting of Sweep Time (SWEEP TIME/DIV)

There are two methods available for setting the sweep time using the GPIB. One is to set the sweep by making it long (or short) in steps of 1-2-5 using the command (TU or TD) corresponding to the key on the front panel. The other method is to set the sweep time directly.

(1) When Using the Command Corresponding to the Key



Example 6-15: Setting the Sweep Time to 200 ms/DIV.

HP200/300 Series

```

10 OUTPUT 701; "OPST"
20 ENTER 701;T
30 IF T<=0.2 THEN 60
40 OUTPUT 701; "TD"
50 GOTO 20
60 IF T=0.2 THEN 90
70 OUTPUT 701; "TU"
80 GOTO 20
90 END

```

Line No.	Meaning
10	Instructs this equipment to output the value of the sweep time.
20	Reads the data (the value of the sweep time).
30	Branches to line No. 60 when the read data is smaller than or equal to 0.2.
40	Sends the TIME/DIV DOWN key  command to lower the sweep time by 1 step (to speed up the sweeping).
50	Returns to line No. 20.
60	Branches to line No. 90 when the read data is equal to 0.2.
70	Sends the TIME/DIV key  command to raise the value of the sweep time by 1 step (to slowdown the sweeping).
80	Returns to line No. 20.
90	End of program

(2) When the Sweep Time Is Set Directly

Example 6-16: Setting the Sweep Time to 200 ms/DIV Directly

HP200/300 Series

```
10 OUTPUT 701: "ST200MS"
20 END
```

Line No.	Meaning
10	Sets the sweep time to 200 ms/DIV.
20	End of program

When the value of the sweep time is set directly, do it using the codes shown in the table below.

Sweep Time Set Value Codes

Code	Sweep time	Code	Sweep time
ST5MS	5 ms/	ST500MS	500 ms/
ST10MS	10 ms/	ST1S	1 s/
ST20MS	20 ms/	ST2S	2 s/
ST50MS	50 ms/	ST5S	5 s/
ST100MS	100 ms/	ST10S	10 s/
ST200MS	200 ms/	ST20S	20 s/
		ST50S	50 s/
		ST100S	100 s/

6.5 Output of Setting Conditions

To make the system output the set data of measurement parameters, call it directly using the "OP" command, or make it output the mode strings to detect it.

6.5.1 "OP" Command

When making the measurement parameter output directly, use the "OP" command (Output Interrogated Parameter).

Following the "OP" command, the OP parameter code of the set data to be output is sent to this equipment.

The OP parameters of this equipment are shown below.

OP Parameter Codes

Code	Parameter output
AT	ATTENUATOR
CF	CENTER FREQUENCY
MF	MARKER FREQUENCY
ML	MARKER LEVEL
RB	RESOLUTION BAND WIDTH
RL	REFERENCE LEVEL
SP	FREQ SPAN
ST	SWEEP TIME
VF	VIDEO FILTER BAND WIDTH
PL	DISPLAY LINE
OB	OCCUPIED BAND WIDTH (for R4131D)

Program examples to output the set data are given below.

6.5 Output of Setting Conditions

Example 6-17: Setting the Value of the Center Frequency and Reference Level, and Making These Data Display by Reading It from This Equipment

HP200/300 Series

```

10 OUTPUT 701; "CF470MZ"
20 OUTPUT 701; "RL-30DM"
30 OUTPUT 701; "OPCF"
40 ENTER 701; F
50 OUTPUT 701; "OPRL"
60 ENTER 701; L
70 DISP F,L
80 END

```

Line No.	Meaning
10	Sets the center frequency to 470 MHz.
20	Sets the reference level to -30 dBm.
30	Instructs this equipment to output the set data of center frequency.
40	Reads the data and fetches it to variable F.
50	Instructs this equipment to output the set data of the reference level.
60	Reads the data and fetches it to variable L.
70	Displays the value of variables F and L. The value is displayed as "470000000 -30" in this example.
80	End of program

After the execution of the above program, the "470000000 -30" is displayed on the screen.

6.5.2 Format of Output Data

The format of the output data by the "OP" command is as shown below:

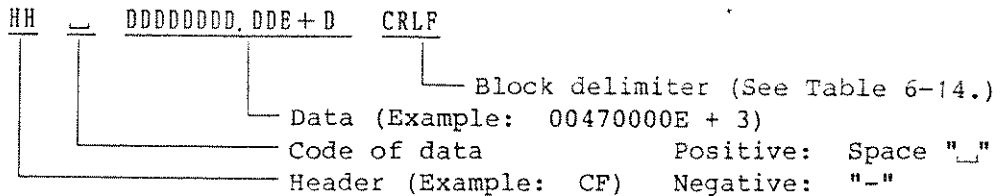

The data output from this equipment is all output in this format excluding the trace data and status byte. Since the total number of bytes of data is 17 bytes, make an array declaration with more than 17 bytes when the data is input as a character array variable from the GPIB controller, etc.

The header in the head of output data indicates the type of data and it varies according to the data to be output. See Item (1).

The header may be omitted when not required. The header is set to OFF by the "HD 0" command and to ON by the "HD 1" command.

Header set examples are given below:

(1) Header

The header in the head of output data indicates the type of data, and it varies according to the data to be output.

The table below shows the relation between the output data and header.

Relation Between Output Data and Header

Type of output data		Header	
CENTER FREQUENCY		CF	
SPAN		SP	
REFERENCE LEVEL	dBm	DM	
	dB μ	DU	
	dB μ /m	VM	
	LINEAR	LV	
	dBmV	DQ	
SWEEP TIME/DIV		ST	
RESOLUTION BAND WIDTH		RB	
VIDEO FILTER		VF	
ATT		AT	
MARKER	FREQUENCY	MF	
	LEVEL	dBm	MM
		dB μ	MU
		dB μ /m	ME
		LINEAR	ML
		dBmV	MQ

The header may be omitted when not required.

The header is set to OFF by the "HD 0" command and to ON by the "HD 1" command. Header set examples are given below:

R4131 SERIES
SPECTRUM ANALYZER
INSTRUCTION MANUAL

6.5 Output of Setting Conditions

Example 6-18: Setting the Header to OFF and Fetching the Value of Center Frequency as a Character String. Next, Setting the Header to ON and Fetching the Value of Center Frequency as a Character String.

HP200/300 Series

```

10 DIM A$(17)
20 OUTPUT 701; "HDO OPCF"
30 ENTER 701; A$
40 PRINT A$
50 OUTPUT 701; "HD1"
60 ENTER 701; A$
70 PRINT A$
80 END

```

Line No.	Meaning
10	Declares the length of character string A\$ to be 17 characters.
20	Sets the header of output data of this equipment to OFF. Also, instructs this equipment to output the value of the center frequency.
30	Reads the data and fetches it to character string variable A\$.
40	Displays the value of character string variable A\$. When the center frequency is 400 MHz, for instance, the value is displayed as " 00400000.00E+3".
50	Sets the header of output data of this equipment to ON.
60	Reads the data and fetches it to character string variable A\$.
70	Displays the value of character string variable A\$. When the center frequency is 400 MHz, the value is displayed as "CFL00400000.00E+3".
80	End of program

(2) Block Delimiter

The block delimiter indicates the end of signal.

This equipment provides four types of block delimiters as shown in the table below.

Block Delimiter Specified Codes

Code	Block delimiter
DL 1	Outputs the 1-byte code of "LF".
DL 2	Outputs the last byte of data and single-wire signal "EOI" at the same time.
DL 3	Outputs the 2-byte codes of "CR" and "LF".
DL 0	Outputs the 2-byte codes of "CR" and "LF". Also, outputs the single-wire signal "EOI" simultaneously with "LF".

When a command or data is sent from the GPIB controller, etc., to this equipment, it accepts the command or data, if the sent command or data is applicable to either one of the above-mentioned block delimiters. When the block delimiter is not applicable to either one of the above four types, the GPIB of this equipment will not operate normally.

When data is fetched from this equipment, the block delimiter of this equipment must be set to that of the data receiving side (GPIB controller, etc.). Select either one of the above four types.

The block delimiter can be changed to a different type of block delimiter by sending the appropriate command for the desired block delimiter from the GPIB controller.

The block delimiter of this equipment is set to DL 3 at power ON.

6.5.3 Mode String

The set value of center frequency and frequency span of this equipment can be output the "OP" command. The setting status of the other keys (e.g., INPUT ATTENUATOR key, etc.) can be checked by the mode string when output.

The mode string is composed of seven bytes of binary code. Each byte indicates the setting status of each function of this equipment.

When the mode string is to be output, use the "OM" (OUTPUT MODE STRING) command. When this command is sent, this equipment outputs the mode string when it is specified to TALKER.

When the mode string is output, the delimiter of the data adds the EOI of the single-wire signal to the last byte (the seventh byte). The CR and LF codes are not used.

The meanings of each byte of the mode string and the functions to be read are as follows:

- 1st byte: Setting status of MIN INPUT ATTENUATOR
- 2nd byte: Setting status of 10 dB/, 2 dB/, 5 dB/, LINEAR switches
- 3rd byte: Setting status of the unit (UNITS switch) of the reference level
- 4th byte: Setting of reference level FINE/COARSE SELECTION switch
- 5th byte: Setting status of trigger mode
- 6th byte: Definition of whether the setting of data knob is CENTER
FREQ or MARKER
- 7th byte: Definition of whether the AFC mode is ON or OFF

Mode String

Byte #	Bit usage	Decimal value	Description
	7 6 5 4 3 2 1 0		
1	0 0 0 0 0 0 0 0	0	INPUT ATTENUATOR: 0 dB
	0 0 0 0 0 0 0 1	1	10 dB
	0 0 0 0 0 0 1 0	2	20 dB
	0 0 0 0 0 0 1 1	3	30 dB
	0 0 0 0 0 1 0 0	4	40 dB
	0 0 0 0 0 1 0 1	5	50 dB
2	0 0 0 0 0 0 0 0	0	Tube surface ordinates 10 dB/DIV
	0 0 0 0 0 0 0 1	1	axis display: 2 dB/DIV
	0 0 0 0 0 0 1 0	2	5 dB/DIV(QP)
	0 0 0 0 0 0 1 1	3	LINEAR
3	0 0 0 0 0 0 0 0	0	Display unit of dBm
	0 0 0 0 0 0 0 1	1	REFERENCE LEVEL: dBμ
	0 0 0 0 0 0 1 0	2	dBμ/m(A)
	0 0 0 0 0 0 1 1	3	dBμ/m(B)
	0 0 0 0 0 1 0 0	4	dBμ/m(C)
	0 0 0 0 0 1 0 1	5	dBμ/m(D)
	0 0 0 0 0 1 1 0	6	mV, μV
	0 0 0 0 0 1 1 1	7	dBmV
4	0 0 0 0 0 0 0 0	0	REFERENCE LEVEL: COARSE
	0 0 0 0 0 0 0 1	1	FINE
5	0 0 0 0 0 0 0 0	0	TRIGGER MODE: FREE RUN
	0 0 0 0 0 0 0 1	1	LINE
	0 0 0 0 0 0 1 0	2	VIDEO
	0 0 0 0 0 0 1 1	3	SINGLE
6	0 0 0 0 0 0 0 0	0	DATA KNOB: MARKER
	0 0 0 0 0 0 0 1	1	CF
7	0 0 0 0 0 0 0 0	0	AFC: OFF
	0 0 0 0 0 0 0 1	1	ON

R4131 SERIES
SPECTRUM ANALYZER
INSTRUCTION MANUAL

6.5 Output of Setting Conditions

Example 6-19: Detecting the Value of Attenuator by Making the Mode String Output

HP200/300 Series

```
10 DIM M(6)
20 OUTPUT 701; "OM"
30 ENTER 701 USING
   "#, B"; M(*)
40 DISP M(0)
50 END
```

Line No.	Meaning
10	Secures 7 bytes for variable M.
20	Specifies the output of the mode string.
30	Fetches the mode string.
40	Displays the 1st byte (ATTENUATOR) of the mode string.
50	End of program

6.6 Input/Output of Trace Data

This equipment can output the trace data (waveform displayed on the screen). It also can input the same data from outside. This function makes it possible to analyze and arithmetically process the waveform data using the controller.

The trace data on the screen of this equipment is composed of 701 points of data on the frequency axis (horizontal axis). For input/output of the trace data, this 701-point data is input or output from the left (lower ones in frequency) sequentially. The trace data of each point is expressed with integers from 0 to 511 (Figure 6-5).

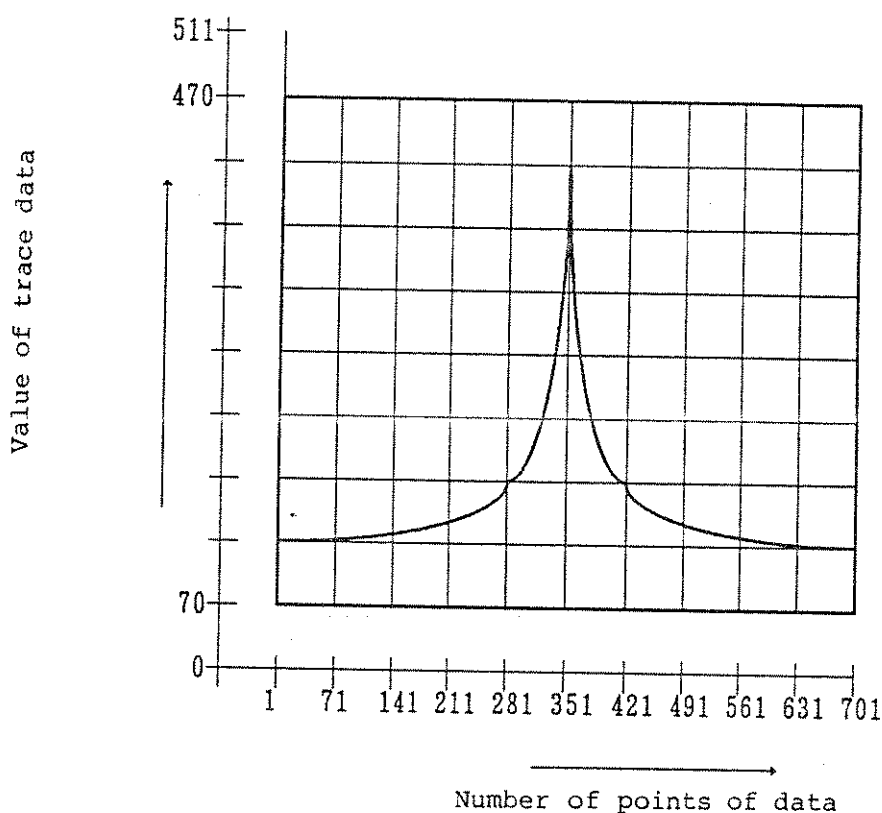

Figure 6-5 Correlation Between Screen Grids and Trace Data

The input/output of trace data can be made in two forms, ASCII code and binary code. Of the two, the ASCII code is convenient when data is input or output point by point. When the data is input or output for one screen (701 points) all together, the binary code is faster in finishing the processing. Use these two ways case by case.

6.6.1 Output of Trace Data

The "OP" command is used for the output of trace data. When the parameter code is sent in succession to the "OP" command, the desired trace data can be output. For the parameter codes of trace data, see the table below.

Trace Data Parameter Codes

Code	Data to be input or output	Type of data
TAA	Trace data of VIEW screen memory	ASCII code
TAW	Trace data of WRITE screen memory	
TBA	Trace data of VIEW screen memory	Binary code
TBW	Trace data of WRITE screen memory	

(1) Method to Output the Trace Data with ASCII Code

OUTPUT 701; "OPTAW"

When this program is executed, this equipment outputs the trace data of the WRITE screen memory with the ASCII code when it is specified to TALKER.

ENTER 701; A

When this program is executed, the trace data for one point is fetched to variable A. When the same ENTER statement is executed, the trace data of the second point, third point ... can be obtained sequentially.

The data format at this time is expressed in 4-digit numerics with no header as shown below:

```

DDDD   CRLF
  |       |
  |       |----- Block delimiter
  |       |----- Trace data (for one point: 0511 for
  |       | instance)

```

When the trace data is fetched as a character string variable, declare the array by setting the length of the character string variable used to more than 4 bytes.

A program example to output the trace data with ASCII code

Example 6-20: Output the trace data in memory with ASCII code, and store in array variable.

HP200/300 Series

```

10 DIM A(700)
20 OUTPUT 701; "OPTAW"
30 FOR I=0 TO 700
40 ENTER 701; A(I)
50 NEXT I
60 END

```

Line No.	Meaning
10	Declares array variable A(I) up to 701 points.
20	Instructs this equipment to output the trace data of the WRITE screen memory with the ASCII code.
30	Instructs this equipment to vary variable I from 0 to 700 one by one. (The loop is repeated 701 times.)
40	Reads the trace data for one point and stores it in array variable A(I).
50	Increments variable I by 1 only, and returns to line No. 40 when I < 700, but runs on to the next line when I ≥ 700.
60	End of program

(2) Method to Output Data with the Binary Code

OUTPUT 701; "OPTBW"

When this program is executed, this equipment outputs the trace data of the WRITE screen memory with the binary code when it is specified to TALKER. Since 701 points of trace data (for 1 screen) is output all together at this time, the controller side should be ready to input the 701 points of data at the one time. Also, since the EOI signal is specified to the delimiter when the data is output with the binary code, the controller side should continue the data input until the EOI signal can be detected.

The data output format with the binary code is shown below:

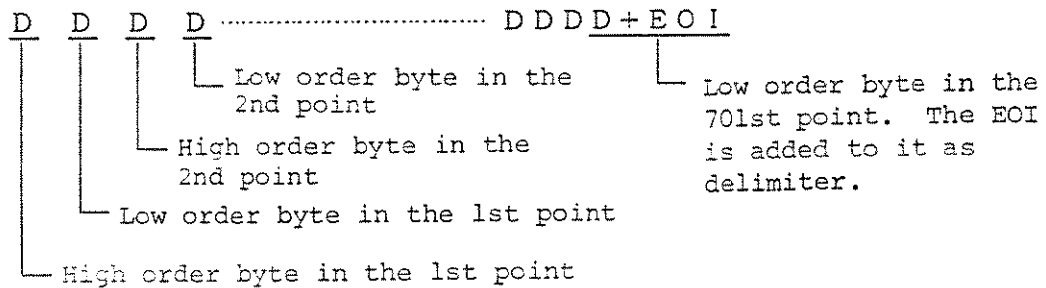

One point of data consists of 9 bits in the binary code. Consequently, one point of data is expressed in 2 bytes which are divided into high order byte and low order byte. When the data is output to the GPIB, the upper byte in the first is output first and then the low order byte in the first point, followed by the high order byte in the second point and so forth, and lastly the low order byte in the 70th point.

Example 6-21: The trace data in the memory is output with the binary code to be stored in an array variable.

HP200/300 Series

```

10 DIM A(700)
20 OUTPUT 701; "OPTBW"
30 FOR I=0 TO 700
40 ENTER 701 USING "#,W"; A(I)
50 NEXT I
60 END
  
```

Line No.	Meaning
10	Declares numeric array variable A(I) for as many numbers as required.
20	Instructs this equipment to output the trace data in the WRITE screen memory with the binary code.
30	Instructs this equipment to vary variable I from 0 to 700 one by one. (The loop is repeated 701 times.)
40	Fetches 2-byte binary data, converts it into decimal data, and stores it in numeric array variable A(I). Then, increments variable
50	I by 1 only. When I is < 700, the program execution returns to the preceding line. When I ≥ 700, it proceeds to the next line.
60	End of program. (Usually, the trace data execution program is input after this.)

6.6.2 Input of Trace Data

The "IN" command is used to input the trace data in R4131. When the parameter code of trace code is sent to this equipment after the "IN" command, the desired trace data can be input. The parameter code of trace data used for this input is the same as the code used in its output.

(1) Method to Input the Trace Data with the ASCII Code

OUTPUT 701; "INTAA"

When programmed and executed like this, this equipment enters the input mode of the trace data. When the data is sent to this equipment with the ASCII code after this, that data is stored in the first point of the VIEW screen memory.

When the data is sent further, the trace data is set to the second point, third point ... in the memory, sequentially.

If any data other than the trace data is sent to the equipment under this status, this equipment automatically exits from the trace data input mode and returns to its routine status.

The data format is the same as that when the data is output with the ASCII code.

A program example to input the trace data with the ASCII code

Example 6-22: The trace data is assumed to be provided in numeric array variable A(I). The data in A(I) is then input to the VIEW screen memory of this equipment with the ASCII code.

HP200/300 Series

```
      .  
      .  
      .  
      .  
      .  
      .  
100  OUTPUT 701; "INTAA"  
110  FOR I=0 TO 700  
120  OUTPUT 701; INT(A(I))  
130  NEXT I  
140  END
```

R4131 SERIES
SPECTRUM ANALYZER
INSTRUCTION MANUAL

6.6 Input/Output of Trace Data

Line No.	Meaning
100	Instructs this equipment to receive the trace data to the VIEW screen memory with the ASCII code.
110	Instructs this equipment to vary variable I from 0 to 700, one by one. (The loop is repeated 701 times.)
120	Converts the data in array A(I) into integers and sends it to this equipment.
130	Increments the value of variable I by 1 only. When $I < 700$, the program execution returns to line No. 120. When $I \geq 700$, it proceeds to the next line.
140	End of program

When this equipment is set to the VIEW mode after the execution of this program, it is possible to see the tracing waveform by the input data.

(2) Method to Input the Trace Data with the Binary Code

```
OUTPUT 701; "INTBA"
```

When programmed and executed like this, this equipment enters the trace data input mode with the binary code. In the binary code, input the trace data for one screen (701 points) all together at a time. Since R4131 continues the data input until the EOI signal is detected, be sure to add the EOI to the last byte of the trace data.

The data format is the same as in the output of the trace data with the binary code. A program example for the input of trace data is as follows:

A program example to input the trace data with the binary code

Example 6-23: The trace data is assumed to be provided in the numeric array variable A(I). The data in A(I) is then input in the VIEW screen memory of this equipment with the binary code.

HP200/300 Series

```
.  
. .  
. .  
. .  
. .
```

```
100 OUTPUT 701; "INTBA"  
110 FOR I=0 TO 699  
120 OUTPUT 701 USING "#,W"; A(I)  
130 NEXT I  
140 OUTPUT 701 USING "#,w"; A(I), END  
150 END
```

R4131 SERIES
SPECTRUM ANALYZER
INSTRUCTION MANUAL

6.6 Input/Output of Trace Data

Line No.	Meaning
100	Instructs this equipment to receive the trace data in its VIEW screen memory with the binary code, and to make a change so that the EOI is added to the last byte of the delimiter.
110	Instructs this equipment to vary variable I from 0 to 699, one by one. (The loop is repeated 701 times.)
120	Converts the data of numeric array A(I) into 2-byte binary code and sends it to this equipment.
130	Increments variable I by 1 only. When $I < 699$, the program execution returns to the preceding line. When $I \geq 699$, it proceeds to the next line.
140	Adds the EOI signal when the last point data is set.
150	End of program

When this equipment is set to the VIEW mode after the execution of the above program, it is possible to see the trace data input through the input data.

6.7 Service Request

By using the service request function of GPIB, various statuses of this equipment can be detected from the outside.

Contents of the service request can be known from status bytes shown in Table 6-17.

Status Byte

Bit #	Decimal value	Function
7	128	End of sweep
6	64	Service request (SRQ)
5	32	
4	16	CF CAL
3	8	Signal track
2	4	Marker search
1	2	Center frequency set
0	1	ZERO CAL

(1) Status Byte

Each bit of the status byte is set to "1" when the following conditions are met.

Status byte

- Bit 0: "1" is set when ZERO CAL is executed and the calibration is finished.
- Bit 1: "1" is set when the center frequency is set using the "CF" command of GPIB.
- Bit 2: "1" is set if the marker ends the searching when the searching function is executed by the marker.
- Bit 3: This bit is changed from 0 to 1 when the waveform peak position is ended to be set to the center frequency during the execution of the signal tracking function of marker.
- Bit 4: "1" is set when the CF CL is executed and the calibration is finished.
- Bit 6: When "1" is set to either bit 0 to bit 5, or bit 7 and the service request (SRQ) is transmitted, this bit also goes to "1" at the same time.
- Bit 7: "1" is set when the sweeping ends.

This service request is turned ON/OFF by GPIB commands "S0" and "S1".

When the status byte is read, this equipment clears the status byte.

(2) Output of Status Byte

The status byte can be read when the serial polling is executed as shown in the following example:

Example 6-24: ZERO CAL is judged to be ended by reading the status byte.

HP200/300 Series

```
10 OUTPUT 701; "SHFL"  
20 S=SPOLL(701)  
30 IF BIT(S,0)<>1 THEN 20  
40 OUTPUT 701;"CF200MZ SP100KZ"  
50 END
```

Line No.	Meaning
10	Executes the ZERO CAL.
20	Reads the status byte and incorporates it in variable S.
30	Waits until bit #0 becomes 1 after the end of the execution of ZERO CAL.
40	For the next setting after the end of ZERO CAL, the center frequency is set to 200 MHz and spans to 100 kHz in this stage.
50	End of program

6.8 Notes in Programming

(1) Noteworthy Points in Sending a Command

When a command is sent to this equipment, the command can be delimited with a space () or comma (,) as shown below:

Example 6-25: A command is delimited with a space () or comma (,) and sent to this equipment.

OUTPUT 701; "S0 OPCF, HD 1"

(2) Noteworthy Points in Spectrum Analysis When the Frequency Span Is Made Narrower

The center frequency setting accuracy is ± 10 MHz or less when R4131C/CN and the AFC of R4131D/DN are set to OFF. Hence, when the center frequency is set directly by setting the frequency span to less than 10 MHz, no spectrum is displayed on the screen in some cases.

Consequently, when the spectrum is analyzed by making the frequency span narrow, try to program so that narrow the span narrows while always seizing the signal.

Example 6-26: The frequency span is made narrow up to 50 kHz for the 200 MHz reference signal.

HP200/300 Series

```

10 OUTPUT 701; "CF 200MZ, SP20MZ, RL-30DM"
20 WAIT 1
30 OUTPUT 701; "SHM4"
40 S=SPOLL(701)
50 IF BIT(S,3)<>1 THEN 40
60 OUTPUT 701; "NR"
70 OUTPUT 701; "OPSP"
80 ENTER 701; A
90 IF A <> 50000 THEN 40
100 END

```

Line No.	Meaning
10	Sets the center frequency to 200 MHz, frequency span to 20 MHz, and reference level to -30 dBm.
20	Waits for 1 sec.
30	Sets the signal tracking function to ON.
40	Reads the status byte and incorporates it to variable S.
50	After the end of signal tracking, waits until bit #3 becomes 1.

R4131 SERIES
SPECTRUM ANALYZER
INSTRUCTION MANUAL

6.8 Notes in Programming

Line No.	Meaning
60	Makes the frequency span narrower by 1 step.
70	Reads the frequency span and sets the mode.
80	Reads the data.
90	Returns to line 40 unless the frequency span is 50 kHz.
100	End of program

(3) Noteworthy Points for the Setting of Center Frequency When the Frequency Span Is Less Than 10 MHz

When the center frequency is changed in the setting of the frequency span to less than 10 MHz, the spectrum shifts after the setting, although varied according to the amount of change. This is caused by the time constant of the frequency stabilization circuit. Note that no correct data is indicated in the case of a program used to read the marker frequency level under this status.

Example 6-27: When the Frequency of the 200 MHz Reference Signal Is Read

HP200/300 Series

```

10 OUTPUT 701; "CF 3500MZ SP 10MZ"
20 WAIT 1
30 OUTPUT 701; "CF 200MZ"
40 WAIT 10
50 OUTPUT 701; "M4"
60 OUTPUT 701; "OPMF"
70 ENTER 701; F
80 DISP F

```

.
.
.
.
.
.

Line No.	Meaning
10	Sets the center frequency to 3500 MHz and frequency span to 10 MHz.
20	Sets the waiting time for 1 sec.
30	Sets the center frequency to 200 MHz.
40	Takes the waiting time here until the spectrum is stabilized (approx. 10 sec. maximum). The waiting time is set to 10 sec. in this example.
50	Executes the PEAK SEARCH.
60	Reads the marker frequency.
70	Incorporates the marker frequency to variable F.
80	Displays the marker frequency.

R4131 SERIES
SPECTRUM ANALYZER
INSTRUCTION MANUAL

6.9 List of GPIB Codes

6.9 List of GPIB Codes

Table 6-4 List of GPIB Codes

Setting	Code	Remarks	Setting	Code	Remarks				
Input of measuring condition	Command code corresponding to each key See Figure E-1.		Input of trace data	IN	Memory, ASCII/ binary specified code is the same as in its output.				
Output of measuring condition and trace data	OP Freezing the screen data by the OP parameter code. Specifies the output waveform data by the trace memory, ASCII/binary specified code.		Output of the status byte	OS	The EO1 is added to the last byte of data as a delimiter. (CR LF is not used.)				
OP parameter code		Output format of output data	Output of the mode string	OM					
ATTENUATOR	AT	<p>(Number of bytes: 17 except delimiters)</p> <p>HH DDDDDDDD.DD E=0 CR LF</p> <p>Block delimiter</p> <p>Data index part</p> <p>Data mantissa</p> <p>Data code { Positive: Space " " (Blank) Negative: "-"</p> <p>Header</p>	Service request Transmitted	SO	"SI" at the power ON				
CENTER FREQUENCY	CF		Service request Not transmitted	SI					
MARKER FREQUENCY	MF		Initialization	IP					
MARKER LEVEL	ML		Header OFF	HDO	"HD1" at the power ON				
RESOLUTION BAND WIDTH	RB		Header ON	HD1					
REFERENCE LEVEL	RL		Header to be output						
FREQ SPAN	SP		CENTER FREQUENCY	CF	FREQUENCY SPAN	SP	MARKER FREQUENCY	MF	
SWEEP TIME	ST		REFERENCE LEVEL	RL	RESOLUTION	RB	LEVEL	dBm	MW
VIDEO FILTER BAND WIDTH	VF		LEVEL	dB μ	BAND WIDTH	DU		dB μ	MU
DISPLAY LINE	PL		dB μ /m	DM	VIDEO FILTER	VF		dB μ /m	ME
OCCUPIED FREQUENCY BAND WIDTH (R4131D only)	OB		LINEAR	LV	BAND WIDTH	VN		LINEAR	ML
			dBmV	DQ	ATTENUATOR	AT		dBmV	MQ
Trace memory, and ASCII/ binary specified code			Output format of trace data	Block delimiter	CR, LF, EO1	DLO	"DL3" at the power ON		
Trace data of memory A	TAA	ASCII DDDD CR LF (Number of bytes: 4 except delimiters)	LF	DL1					
ASCII output	TAA	Block delimiter	EO1	DL2					
Binary output	TBA	Trace data (for a point)	CR, LF	DL3					
WRITE memory trace data	TAW	Binary DDD-DDD (Number of bytes: 1402 except delimiters)							
ASCII output	TAW	High/low order bytes in the 701st point							
Binary output	TBW	High order byte in the 2nd point							
		Low order byte in the 1st point							
		High order byte in the 1st point							
		(1-point data in 2 bytes)							

Table 6-5 GPIB Code Corresponding to Each Key

Key	Code	Key	Code
INSTR PRESET	IP (SHMO)	ATT 0dB	A0
CTR FREQ	CF	VIDEO FLTR	
DATA KNOB		UP	VU
COARSE DOWN	CD	DOWN	VD
UP	CU	SWEEP TIME/DIV	
FINE DOWN	FD	UP	TU
UP	FU	DOWN	TD
MARKER ON	M1	TRIGGER	TR
OFF	M0	START/RESET	SR
MKR CF	M3	LCL	LC
PEAK	M4	WRITE	WR
CF CAL	FL	STORE	SE
FREQ SPAN	SP	VIEW	VW
ZERO SPAN	ZS (SHSP)	MAX HOLD	MA (SHWR)
AUTO	BA	RECALL	RC
RBW	RB	SAVE	SV (SHRC)
FREQ SPAN, RBW		CF ADJ	SHCF
WIDE	WD	OBW	SHM1 *
NARROW	NR	AFC	SHM3 **
UP	LU	SIG TRK	SHM4
DOWN	LD	ZERO CAL	SHFL
FINE/COARSE	FC	NOISE/Hz	SHBA
10dB/DIV	L1 (SHLD)	NORMALIZATION	SHRB
2dB/DIV	L2 (SHLU)	DSPL LINE	SHWD
QP	L3 (SHFC)	NORMAL DET	SHVD **
LINEAR	LN (SHUN)	POS DET	SHTD
UNITS	UN	SAMPLE DET	SHTR
INPUT ATTENUATOR			
UP	AU		
DOWN	AD		

Note: Codes marked with one asterisk (*) are available for R4131D.
Codes marked with two asterisks (**) are available for R4131D/DN only.

R4131 SERIES
SPECTRUM ANALYZER
INSTRUCTION MANUAL

6.9 List of GPIB Codes

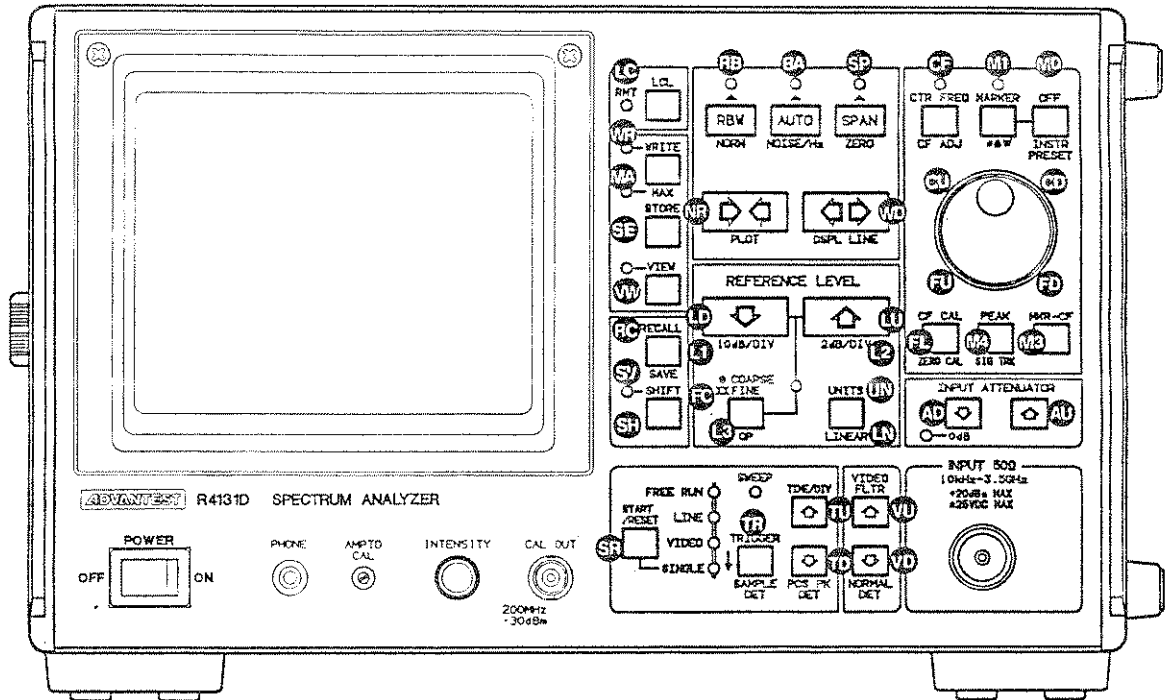

Figure 6 - 6 GPIB Code for each Key

Table 6 - 6 Direct Set GPIB Codes

Contents		Code
UNITS	dBm	DM
	dB μ	DU
	dB μ /m (A)	D1
	dB μ /m (B)	D2
	dB μ /m (C)	D3
	dB μ /m (D)	D4
	dBmV	DV
Trigger Mode	FREE RUN	FR
	LINE	LI
	VIDEO	VT
	SINGLE	SI
Attenuator	0 dB	A0
	10 dB	A1
	20 dB	A2
	30 dB	A3
	40 dB	A4
	50 dB	A5
Contents	data Code + <input type="checkbox"/> <input type="checkbox"/>	
Center frequency	CF <input type="checkbox"/> <input type="checkbox"/>	
Reference level	RL <input type="checkbox"/> <input type="checkbox"/>	
Frequency span	SP <input type="checkbox"/> <input type="checkbox"/>	
Resolution band width	RB <input type="checkbox"/> <input type="checkbox"/>	
Marker	MK <input type="checkbox"/> <input type="checkbox"/>	
Video filter band width	VF <input type="checkbox"/> <input type="checkbox"/>	
Sweep time	ST <input type="checkbox"/> <input type="checkbox"/>	
Display line	PL <input type="checkbox"/> <input type="checkbox"/>	

Table 6 - 7 Unit Display GPIB Codes

Unit	Code
GHz	GZ
MHz	MZ
kHz	KZ
Hz	HZ
V	V
mV	MV
μ V	UV
sec	S
msec	MS
dBm	DM
dB μ	DU
dB μ /m (A)	D1
dB μ /m (B)	D2
dB μ /m (C)	D3
dB μ /m (D)	D4

R4131 SERIES
SPECTRUM ANALYZER
INSTRUCTION MANUAL

6.9 List of GPIB Codes

Table 6 - 8 Numeric Value Code in Setting Condition Input

	Code	Set value
Video band width	VF10HZ	10Hz
	VF100HZ	100Hz
	VF1KZ	1kHz
	VF10KZ	10kHz
	VF100KZ	100kHz
	VF300KZ	300kHz
	VF1MZ	1MHz
Sweep time	ST5MS	5 ms/
	ST10MS	10 ms/
	ST20MS	20 ms/
	ST50MS	50 ms/
	ST100MS	100 ms/
	ST200MS	200 ms/
	ST500MS	500 ms/
	ST1S	1 s/
	ST2S	2 s/
	ST5S	5 s/
	ST10S	10 s/
	ST20S	20 s/
	ST50S	50 s/
ST100S	100 s/	
Attenuator	A0	0 dB
	A1	10 dB
	A2	20 dB
	A3	30 dB
	A4	40 dB
	A5	50 dB
Frequency span	SP50KZ	50 kHz
	SP100KZ	100 kHz
	SP200KZ	200 kHz
	SP500KZ	500 kHz
	SP1MZ	1 MHz
	SP2MZ	2 MHz
	SP5MZ	5 MHz
	SP10MZ	10 MHz
	SP20MZ	20 MHz
	SP50MZ	50 MHz
	SP100MZ	100 MHz
	SP200MZ	200 MHz
	SP500MZ	500 MHz
	SP1GZ	1 GHz
	SP2GZ	2 GHz
SP4GZ	4 GHz	
ZS	ZEROSPAN	
Resolution band width	RB1KZ	1 kHz
	RB3KZ	3 kHz
	RB10KZ	10 kHz
	RB30KZ	30 kHz
	RB100KZ	100 kHz
	RB300KZ	300 kHz
	RB1MZ	1 MHz

Table 6 - 9 Mode String

Byte #	Bit 76543210	Decimal value	Contents
1	00000000	0	INPUT ATT
	00000001	1	0 dB
	00000010	2	10 dB
	00000011	3	20 dB
	00000100	4	30 dB
	00000101	5	40 dB
2	00000000	0	Tube surface
	00000001	1	ordinates
	00000010	2	axis display
	00000011	3	10 dB/DIV 2 dB/DIV 5 dB/DIV (QP) LINEAR
3	00000000	0	Ordinates axis
	00000001	1	unit, dB μ
	00000010	2	dB μ /m (A)
	00000011	3	dB μ /m (B)
	00000100	4	dB μ /m (C)
	00000101	5	dB μ /m (D)
	00000110	6	mV, μ V
00000111	7	dBmV	
4	00000000	0	REF LVL STEP
	00000001	1	SIZE: COARSE FINE
5	00000000	0	TRIGGER MODE
	00000001	1	FREE RUN
	00000010	2	LINE
	00000011	3	VIDEO SINGLE
6	00000000	0	Data knob
	00000001	1	Marker CF
7	00000000	0	AFC
	00000001	1	OFF ON

Table 6 - 10 Status Byte

Bit	Decimal value	Function (set to 1 when ended)
7	128	End of sweeping
6	64	Service request
5	32	
4	16	CF CAL
3	8	Signal track
2	4	Marker search
1	2	Center frequency setting
0	1	ZERO CAL

MEMO 

MEMORANDUM FOR THE RECORD

R4131 SERIES
SPECTRUM ANALYZER
INSTRUCTION MANUAL

7. INSPECTION AND MAINTENANCE

7. INSPECTION AND MAINTENANCE

Defects and Abnormal Stresses

When the R4131C, R4131CN, R4131D, R4131DN is impaired as undermentioned, it is thought that the protective function is damaged.

Before the R4131C, R4131CN, R4131D, R4131DN is used, make sure to find the damage and ensure the safety of this equipment at your nearest support office.

The instruments:

- show visible damage,
- fails to perform the intended measurements,
- has been subjected to prolonged storage under unfavourable conditions,
- has been subjected to severe transport stresses.

WARNING

To remove the unit case is allowed only for the trained service personnel because there is danger of the electric shock.

7.2 Notes in Storing and Shipping this Equipment

7.2.1 Storage of This Equipment

The storage temperature range of this equipment is -20°C to $+70^{\circ}\text{C}$. When this equipment is not used for a long period of time, cover it with vinyl or put in a cardboard box, and store it in a dry place away from direct sunlight.

7.2.2 Cleaning of This Equipment

Periodically take off the filter which protects the CRT display and clean the inside of the filter and CRT display unit with a soft cloth soaked in alcohol. Do not use any cleaner other than alcohol.

The filter can be taken off by removing two screws of the bezel.

CAUTION

Never use any cleaner other than alcohol for the maintenance of this equipment. Organic solvent such as benzene, toluene or acetone may spoil the plastic parts of this equipment.

7.2.3 Shipment of This Equipment

When shipping this equipment, use the original packing materials. If they are not available, pack the equipment as follows:

- (1) Wrap this equipment in appropriate shock absorbing material and put it in a corrugated cardboard box at least 5 mm thick.
- (2) Wrap its accessories separately in the same shock absorbing material and put them in the same corrugated cardboard box together with this equipment.
- (3) Fasten the corrugated cardboard box with packing strings.

MEMO 

1
2
3
4
5
6
7
8
9
10
11
12
13
14
15
16
17
18
19
20
21
22
23
24
25

R4131 SERIES
SPECTRUM ANALYZER
INSTRUCTION MANUAL

8. Technical Data of
Function and Accessories

8. TECHNICAL DATA OF FUNCTION AND ACCESSORIES

8.1 Technical Data of Function

(1) Frequency Specification

Frequency range : 10 kHz to 3.5 GHz
 Frequency display : Displayed on the CRT screen
 Maximum resolution: 1 kHz (to be changed according to the frequency span)
 Frequency displaying accuracy:

R4131C/CN	Less than ± 10 MHz	After ZERO CAL
R4131D/DN	± 100 kHz + SPAN 3% or less	After ZERO CAL Within the range of 0 Hz to 2.5 GHz in center frequency and 5 ms to 0.5 S/DIV in sweep time.
	± 10 MHz	After ZERO CAL Center frequency 2 GHz or more

Frequency span : 4 GHz to 100 kHz, ZERO 1-2-5 step
 Frequency span accuracy: $\pm 5\%$
 Frequency stability : R4131C/CN
 Less than 100 kHz/5 min.
 Frequency is fixed after warming up for 1 hour under constant temperature.
 R4131D/DN
 Less than 10 kHz/10 min.
 AFC ON
 Frequency is fixed after warming up for 1 hour under constant temperature.
 (Within the range of 0 Hz to 2.5 GHz in center frequency, 5 ms to 0.5 S/DIV in sweep time)
 Residual FM : Less than 2 kHz_{p-p}/100 ms
 Noise sideband :

More than 80 dBc	Where the resolution band width is assumed to be 1 kHz, video filter band width to be 10 Hz, and 20 kHz to be detuned from signal.
------------------	--

Resolution:

- Resolution band width
 - 3 dB 1 kHz to 1 MHz with 1-3 step
 - 6 dB 9 kHz to 120 kHz when QP mode is selected
- Band width selectivity
 - : Less than 15:1 60 dB: 3 ratio of dB resolution band width
- Resolution band width accuracy
 - : Less than $\pm 20\%$
 - Less than the value of CISPR Standards in the QP mode
- Marker display
 - : Can be set freely
- Resolution 1 kHz max. (To be changed according to the SPAN)
- Measuring accuracy ... Center frequency display accuracy + frequency span accuracy

(2) Amplitude Specification

- Tube surface display range
 - : LOG 80 dB 10 dB/DIV
 - 20 dB 2 dB/DIV
 - 40 dB 5 dB/DIV, In the QP mode only
 - LIN 10 DIV
- Linearity
 - : LOG ± 0.15 dB/1 dB
 - ± 1 dB/10 dB
 - ± 1.5 dB/70 dB or more
 - Less than 5% of LIN scale
- Reference level
 - : LOG -69 dBm to +40 dBm: R4131C/D,
 - 40.25 dBu to 150 dBu: R4131CN/DN
 - 10 dB, 1 dB step 10 dB/DIV
 - 1 dB, 0.25 dB step 2 dB/DIV,
 - in the QP mode
 - LIN 72.77 μ V to +22.36 V: R4131C/D
 - (102.9 μ V to +31.62 V: R4131CN/DN)
- Reference level accuracy
 - : Less than ± 1 dB in the LOG mode
 - This value is taken after calibrating the level at a frequency of 200 MHz and input ATT of 10 dB within the range of 0 to 59 dBm (R4131C/D) and 110 dBu to 51 dBu (R4131CN/DN) in reference level.
- Unit of reference level: dBm, dBu, dBu/m, or dBmV, selectable
- Marker display
 - Resolution 0.2 dB 10 dB/DIV
 - 0.05 dB 2 dB/DIV

Dynamic range

Average noise level

..... -110 dBm: R4131C/D
-108 dBm: R4131CN/DN

Resolution band width
1 kHz, Video filter band
width
10 Hz, Input ATT 0 dB,
More than 1 MHz in
frequency

Secondary/tertiary distortion

..... More than 70 dB

Where the input level is
assumed to be -30 dBm
and frequency to be more
than 1 MHz

Frequency response:

R4131C	100 kHz ≤ F ≤ 2 GHz ATT 10 dB or more ±1 dB or less	10 kHz ≤ F ≤ 3.5 GHz ATT 10 dB or more ±3.5 dB or less	
R4131D	100 kHz ≤ F ≤ 2 GHz ATT 10 dB or more ±1 dB or less	10 kHz ≤ F ≤ 3.5 GHz ATT 10 dB or more ±2 dB or less	
R4131CN/DN	100 kHz ≤ F ≤ 1.5 GHz ±1.5 dB or less	10 kHz ≤ F ≤ 2 GHz ±2.5 dB or less	2 kHz ≤ F ≤ 3.5 GHz ±4 dB or less

Residual response: -95 dBm or less: When terminated at input
R4131C/D ATT 0 dB and input 50 Ω
-93 dBm or less: When terminated at input
R4131CN/DN ATT 0 dB and input 75 Ω
Note: At frequency 100 kHz

Video filter band width:

1 MHz, 300 kHz, 100 kHz, 10 kHz, 1 kHz, 100 Hz, or
10 Hz

Resolution selecting accuracy

: Less than ±1 dB at +20°C to +30°C

Gain compression : Less than 1 dB at input of -10 dBm

(3) Sweep Specification

Sweep time : 5 ms/div to 100 s/div with 1-2-5 step
Sweep time accuracy : Less than $\pm 15\%$
Sweep trigger : FREE RUN, LINE, VIDEO, and SINGLE (Reset/Start)

(4) Input Specification

RF input : Approx. 50 N-type input connector: R4131C/D
Approx. 75 N-type input connector: R4131CN/DN

Maximum input level : +20 dBm, ± 25 VDCmax Input ATT 20 dB or more: R4131C/D
127 dBu, ± 25 VDCmax Input ATT 20 dB or more: R4131CN/DN

Input ATT : 0 to 50 dB with a step of 10 dB
Input ATT selecting accuracy : ± 1 dB or less 10 kHz \leq F \leq 2 GHz (10 dB in standard)
 ± 1.5 dB or less 2 GHz < F \leq 3.5 GHz (10 dB in standard)

Input VSWR R4131C/D 100 kHz \leq F \leq 2 GHz
1.5 or less 2 GHz < F \leq 3.5 GHz
2.0 or less At input ATT 10 dB or more

R4131CN/DN 100 kHz \leq F \leq 1.5 GHz
1.5 or less 10 kHz < F \leq 2 GHz
2.0 or less 2 GHz < F \leq 3.5 GHz
2.5 or less At input ATT 10 dB or more

(5) Display Unit Specification

Display : Waveform, setting conditions, and grid
Trace : 2-screen display of WRITE waveform and VIEW waveform
WRITE : Memory is rewritten each time sweep and WRITE waveform is displayed.
STORE : WRITE waveform is stored.
VIEW : Stored waveform data is displayed.
MAX. HOLD : Each time of repetition from the starting point of this function, the maximum signal level on the horizontal axis is measured and displayed.
Dictation : This equipment provides the POSI/NEGA (for R4131D/DN only), POSI, and SAMPLE display and detection functions.

(6) Output Specification

- Output signal for calibration
: 200 MHz \pm 30 kHz, -30 dBm \pm 0.5 dB: R4131C/D
200 MHz \pm 30 kHz, 80 dBu \pm 0.5 dB : R4131CN/DN
- Monitor output : Possible to listen with an earphone (approx. 8 Ω)
- Recorder output : Analog output only for WRITE waveform
X-axis Approx. -5 V to +5 V (approx. 10 k Ω)
Y-axis Approx. 0 V to +4 V (approx. 220 Ω)
- IF output : The IF signal, 3.58 MHz, is output at approx. 50 Ω .
- Video output : This output includes the output terminal to external CRT display and VIDEO plotter, etc., output impedance of approx. 75 Ω , 1 V_{p-p}, and composite signal.
- Probing power terminal \pm 15 V
: 4-pin connector
- GPIB data output : Mode operation and I/O are enabled using the GPIB.
- Plotter interface: Display screen can be recorded by connecting this equipment directly to the plotter without passing through the controller.
- Output for TG:
1st LOCAL OUT -5 dBm or more Approx. 4 GHz to 7.5 GHz
2nd LOCAL OUT -5 dBm or more Approx. 3.77 GHz
SLOPE OUT; Sweep signal output for TG output level correction 2 V/GHz

(7) General Specifications

- Using ambient conditions
: Less than 0 $^{\circ}$ C to 50 $^{\circ}$ C and 85% RH
- Storage temperature range
: -20 $^{\circ}$ C to +70 $^{\circ}$ C
- Power supply : 90 V to 132 V or 198 V to 250 V
48 to 66 Hz
- Power consumption: Less than 120 VA
- External dimensions
: Approx. 300 (W) x 177 (H) x 460 (D) (mm)
- Weight : Approx. 10 kg : R4131C/CN
Approx. 10.5 kg: R4131D/DN

8.2 Accessories

● TR1625 RF Coupler

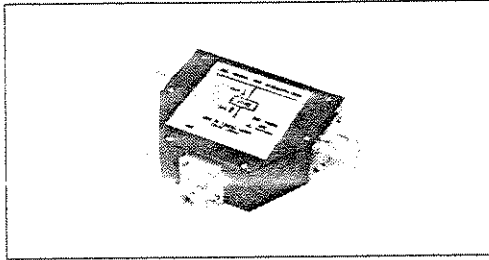

Frequency range : DC-500 MHz
Maximum input : 50 W
Degree of coupling : 40 dB \pm 1 dB
Impedance : 50 Ω in both main and auxiliary lines
V.S.W.R : Less than 1.5
Insertion loss : Less than 1 dB
Connector : Main line ... N-type for both main and auxiliary lines

● TR1626 RF Coupler

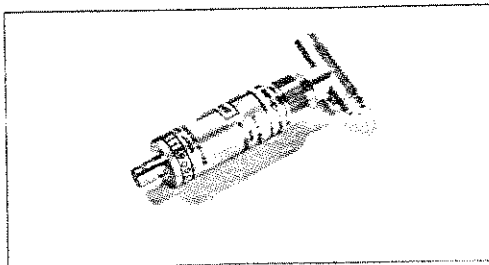

Frequency range : DC-1500 MHz
Maximum input : 50 W
Degree of coupling : 40 dB \pm 1 dB
Impedance : 50 Ω in both main and auxiliary lines
V.S.W.R : Less than 1.5
Insertion loss : Less than 1 dB
Connector : Main line ... N-type, and auxiliary line ... BNC type

● BNC-FJ Conversion Adaptor

Dielectric strength : 500 VAC/1 min.
Insulation resistance: More than 500 k Ω at 500 VDC
Contact resistance : Less than 5 M Ω
V.S.W.R : Less than 1.2 at 0.1 GHz

● Earphone for TR16191 Voice Monitor

When the FREQ SPAN is set to 0 (zero) and this spectrum analyzer is tuned with the data knob, the demodulation wave can be observed on the screen, but also listening can be done through the earphone connected to the phone.

Connection cables

MO-15 Connection cable BNC-BNC (75 Ω)

Part code: DCB-FF0442

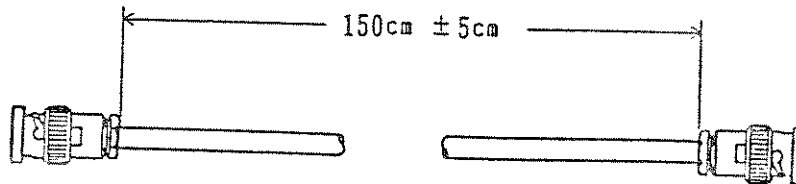

MC-37 Connection cable BNC-SMA

Part code: DCB-FF1130X01

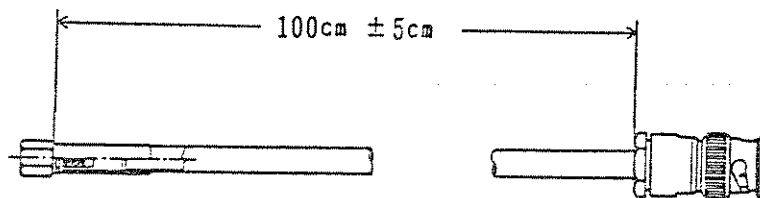

GPIB connection cable

Model name	Length
408JE-1P5	0.5 m
408JE-101	1 m
408JE-102	2 m
408JE-104	4 m

Antenna

- TR1711 Log-periodic Antenna

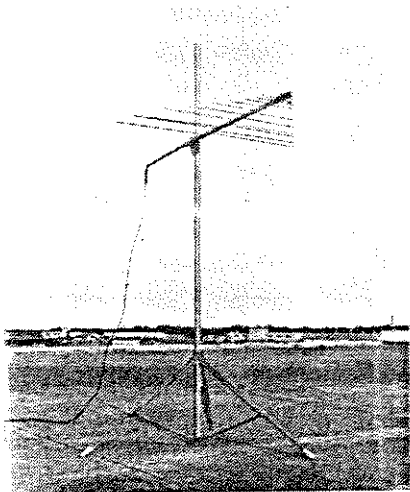

This is a broad band reception antenna of 8 to 1000 MHz in frequency range. It can be used for monitoring radio waves and for analyzing disturbing waves which occurs in wide bands.

Frequency range	:	80 MHz to 1000 MHz
Gain	:	5 dB ($\lambda/2$ dipole antenna ratio)
Front-to-back ratio	:	More than 14 dB
V.S.W.R	:	Less than 2.5
I/O impedance	:	50 Ω
Weight	:	Antenna main body ... Approx. 5 kg
Components	:	Log-periodic antenna (Element 31 x 2, antenna main body, and balancer), angle adjuster (45° to 0° to 90°), tripod, measuring scale (with N-type connector, 10 m), elements container box, and antenna main body container bag

● TR1722 Half-wave Dipole Antenna

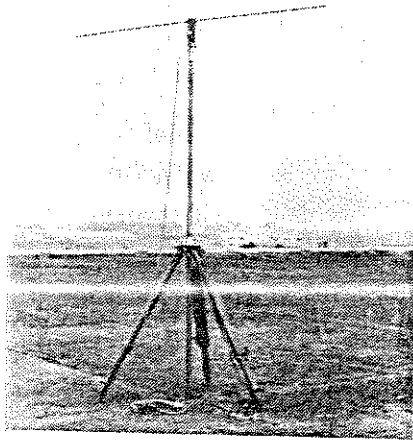

When measuring the field intensity and disturbing wave by using the spectrum analyzer, this antenna is used by changing the length of elements according to the measuring frequency.

Frequency range : 25 MHz to 1000 MHz
Element 1 ... 25 MHz to 80 MHz
Element 2 ... 80 MHz to 250 MHz
Element 3 ... 250 MHz to 600 MHz
Element 4 ... 600 MHz to 1000 MHz

Transmission impedance : 50 Ω

Polarization : Horizontal polarization/vertical polarization selected

Antenna ground height: Approx. 1 to 4 m

Tripod : Folding type

Attached coaxial cable : Attached with 50D, 2W, 10 m, and N-type connector

● TR1720 Loop Antenna

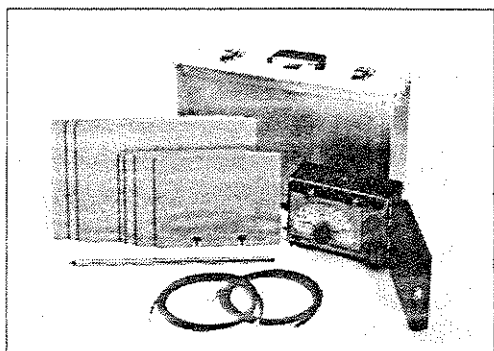

Frequency range	:	100 kHz to 30 MHz
Antenna tuner unit	:	1-band ... 100 kHz to 200 kHz 2-band ... 150 kHz to 300 kHz 3-band ... 300 kHz to 600 kHz 4-band ... 600 kHz to 1400 kHz 5-band ... 1.4 MHz to 3.5 MHz 6-band ... 3.5 MHz to 10 MHz 7-band ... 10 MHz to 30 MHz
Loop antenna section	:	7 types of loop antenna for 1-7 bands
Vertical antenna section	:	Set to 2 m and 1 m in total length
Impedance	:	75 Ω (TR1720N) or 50 Ω (TR1720)
Dimensions and weight:		
Tuner unit	:	Approx. 210 (W) x 140 (H) x 110 (D) (mm); and 2 kg
Loop antenna	:	Approx. 3 kg in one set
Big)	:	Approx. 360 (W) x 250 (H) x 6 (D) (mm)
Small)	:	Approx. 250 (W) x 190 (H) x 6 (D) (mm)
Vertical antenna	:	2 m (5 stages in total length) 1 m (expansion and contraction) and 0.2 kg
Container case	:	Approx. 495 (W) x 290 (H) x 155 (D) (mm) Aluminum made and approx. 1.9 kg in weight

● TR17201 10 kHz to 30 MHz Active Antenna

This is an antenna used for the measurement of field intensity from 10 kHz to 30 MHz. Since it integrates a low noise and broad band amplifier and the antenna factor is almost constant, the field intensity can be directly read easily.

Frequency range	: 10 kHz to 30 MHz
Antenna factor	: Approx. 10 to 13 dB
Output impedance	: Approx. 50 Ω
Input impedance	: More than 1 M Ω (when measured at the antenna block)
Amplification gain	: 7 dB \pm 2 dB in nominal gain
Connector	: BNC type
Power supply	: 12.6 V mercury cell (approx. 20 hours)
External dimensions	: Approx. 131 (L) x 108 (W) x 77 (H) (mm)
Weight	: Approx. 1 kg

● TR17203 25 MHz to 230 MHz Active Dipole Antenna

Since the antenna factor for the measurement of field intensity from 25 MHz to 230 MHz is close to 0 (zero), this antenna can directly read the field intensity in a wide range when used in combination with the spectrum analyzer.

Frequency range	: 25 MHz to 230 MHz
Antenna factor	: Approx. 0 dB
Impedance	: Approx. 50 Ω
Connecting terminal	: N-type
Power supply	: 15 VDC (with 1 m long cable)
Weight	: Approx. 580 g

● TR17204 200 MHz to 1000 MHz Log-periodic Antenna

The antenna can measure a broad band of 200 MHz to 1000 MHz without replacing any element. In addition to its compactness and lightweight, it can be used for transmission and reception. So, it is suitable for immunity measurement in high frequency.

Frequency range	: 200 MHz to 1000 MHz
Antenna factor	: Approx. 14 dB to 25 dB at 200 MHz to 1000 MHz
Impedance	: Approx. 50 Ω
Connecting terminal	: N-type
Average V.S.W.R.	: Less than 2.0
Average gain	: Approx. 7 dB
Antenna dimensions	: Approx. 750 (length) x 750 (maximum width) x 63.5 (thickness) (mm)
Weight	: Approx. 2 kg

● TR17205 1 GHz to 10 GHz Log-spiral Antenna

This is an antenna of 1 GHz to 10 GHz which is used to measure EMI conformable to the MIL Standards.

Frequency range : 1 GHz to 10 GHz
Average power gain : 3.75 dB
Average V.S.W.R. : Less than 2.0
Axial ratio : Less than 1 dB
Average beam width : 50°
Impedance : Approx. 50 Ω
Polarization : Circular polarization
External dimensions : Approx. 381 (length) x 127 (maximum diameter)
(mm)
Weight : Approx. 3.6 kg

● TR17206 1 GHz to 18 GHz Double-ridged Guide Antenna

This is the most suitable antenna for the EMI measurement. It can measure a wide band of 1 GHz to 18 GHz.

Frequency range : 1 GHz to 18 GHz
Average power gain : 10.7 dB (Isotropic)
Average V.S.W.R. : Less than 1.5
Impedance : Approx. 50 Ω
Average beam width : E Plane 53°
H Plane 48°
Connector : N-type
External dimensions : Approx. 280 (L) x 245 (W) x 159 (H) (mm)
Weight : Approx. 1.8 kg

R4131 SERIES
SPECTRUM ANALYZER
INSTRUCTION MANUAL

8.2 Accessories

Filter

MEP-293/MEP-294/MEP-295/MEP-29, TR14101

Model name		MEP-292	MEP-293	MEP-294	MEP-295	TR14101
Filter name		By-pass filter	By-pass filter	By-pass filter	By-pass filter	Rejection filter
Objective communication equipment frequency band		27 MHz	50 MHz	150 MHz	400 MHz	800 MHz to 900 MHz
Working frequency range		26 MHz to 30 MHz	50 MHz to 80 MHz	120 MHz to 190 MHz	335 MHz to 520 MHz	800 MHz to 900 MHz
Filter Characteristics	Cut-off frequency	40 MHz	100 MHz	240 MHz	670 MHz	1200 MHz
	Attenuation characteristic	More than 35 dB at 28 MHz or less More than 40 dB at 27 MHz	More than 50 dB at 70 MHz More than 30 dB at 80 MHz	More than 50 dB at 170 MHz More than 30 dB at 190 MHz	More than 50 dB at 470 MHz More than 30 dB at 520 MHz	More than 35 dB at 800 MHz to 900 MHz More than 30 dB at 800 MHz or less
	Pass band	40 MHz to 300 MHz	100 MHz to 1000 MHz	240 MHz to 1000 MHz	670 MHz to 1500 MHz	1500 MHz to 3000 MHz
	Insertion loss (within the pass band)	Less than 1 dB	Less than 2 dB	Less than 2 dB	Less than 2 dB	Less than 2 dB
Through characteristics	Pass band	DC to 300 MHz	-	-	-	DC to 1000 MHz
	Insertion loss (within the pass band)	Less than 1 dB	-	-	-	Less than 1 dB
Characteristic impedance		50 Ω (BNCJ-BNCJ)	50 Ω (NP-NJ)	50 Ω (NP-NJ)	50 Ω (NP-NJ)	50 Ω (NP-NJ)

R4131 SERIES
SPECTRUM ANALYZER
INSTRUCTION MANUAL

8.2 Accessories

Band Pass Filter

TR14201/14202/14203/14204

This filter is used to remove the large signal out of a measurement band in the measurement conforming to the CISPR Standards using the spectrum analyzer.

	TR14201	TR14202	TR14203	TR14204
Pass band	10 kHz to 150 kHz	150 kHz to 30 MHz	25 MHz to 300 MHz	300 MHz to 1000 MHz
Insertion loss within the pass band	Less than 1.5 dB	Less than 1.5 dB	Less than 1.5 dB	Less than 1.5 dB
Attenuation characteristic	More than 20 dB at less than 3 kHz but more than 300 kHz	More than 35 dB at less than 30 kHz but more than 60 MHz	More than 35 dB at less than 12 MHz but more than 600 MHz	More than 30 dB at less than 150 MHz but more than 1500 MHz
Characteristic impedance (connector)	Approx. 50 Ω (NJ-NP)	Approx. 50 Ω (NJ-NP)	Approx. 50 Ω (NP-NJ)	Approx. 50 Ω (NP-NJ)

External dimensions: Approx. 31 (H) x 50 (S) x 100 (L) (mm)
Weight : Approx. 350 g

MEMO



9. FUNCTIONAL DESCRIPTION



9.1 Outline

9.1.1 Basic Operations

Figure 9-1 shows the block diagram of this equipment.

- (1) When the measuring signal is input to the input connector, the input signal, after passing through the 50 dB RF input attenuator, enters the first mixer where it is mixed with the first local signal sent from the 4 to 7.5 GHz YTO (YIG tuning transmitter), and then it is output as the first IF signal of 4 GHz.

The YTO, under the control of the YTO circuit, sweeps the range of 4 to 7.5 GHz using the RAMP signal and also varies the center frequency with the maximum resolution of 500 Hz.

- (2) The output first IF signal of 4 GHz enters the second mixer where it is mixed with the second local signal of 3.77 GHz and then enters the third mixer as the second IF signal of 226 MHz. This signal is mixed with the third local signal of 200 MHz and then enters the fourth signal as the third IF signal of 26.4 MHz. This signal is further mixed with the fourth local signal of 30 MHz and converted into the fourth IF signal of 3.58 MHz.

Incidentally, the CAL OUT signal of 200 MHz is generated through the crystal oscillator of the third local signal.

- (3) The fourth IF signal of 3.58 MHz passes through the LC filter second stage and crystal filter second stage, through which the resolution band width is selected in a range from 1 MHz to 1 kHz, and further, the output level is controlled by the resolution of 0.25 dB max. by the STEP AMP. of 50 dB.
- (4) The 3.58 MHz IF signal of which resolution band width and output level are controlled enters the LOG AMP. of the dynamic range 80 dB, and after being subjected to logarithmic companding, the signal enters the detector where it is detected and converted into the DC output. The detection output signal enters video filter circuit where the video filter band width is selected to a range from 1 MHz to 10 Hz and then output as the Y. OUT signal.
- (5) The Y. OUT signal and the X. OUT signal of the RAMP signal are both input to the A/D circuit. The Y. OUT (ordinates axis) is converted from analog to digital signal at 9 bits (512 points) and the X. OUT (quadrature axis) is converted the similarly at 10 bits (1024 points). After being stored in the memory, these signals are controlled by the CPU to display the waveform on CRT through the CRT control circuit.

R4131 SERIES
SPECTRUM ANALYZER
INSTRUCTION MANUAL

9.1 Outline

This equipment has two memories, the WRITE memory which rewrites data at each sweeping and VIEW memory which stores the displayed waveform. It also has a non-volatile memory which stores data even after power OFF.

Furthermore, it performs the MAX. HOLD and normalization processing using the WRITE memory, VIEW memory, and the CPU's arithmetic operation function.

- (6) The AFC (Automatic Frequency Control) block is mounted on R4131D/DN only. It applies locking in a range from 4 to 6.5 GHz in the YTO frequency to improve the center frequency setting accuracy.

(This page has been intentionally left blank.)

9.1 Outline

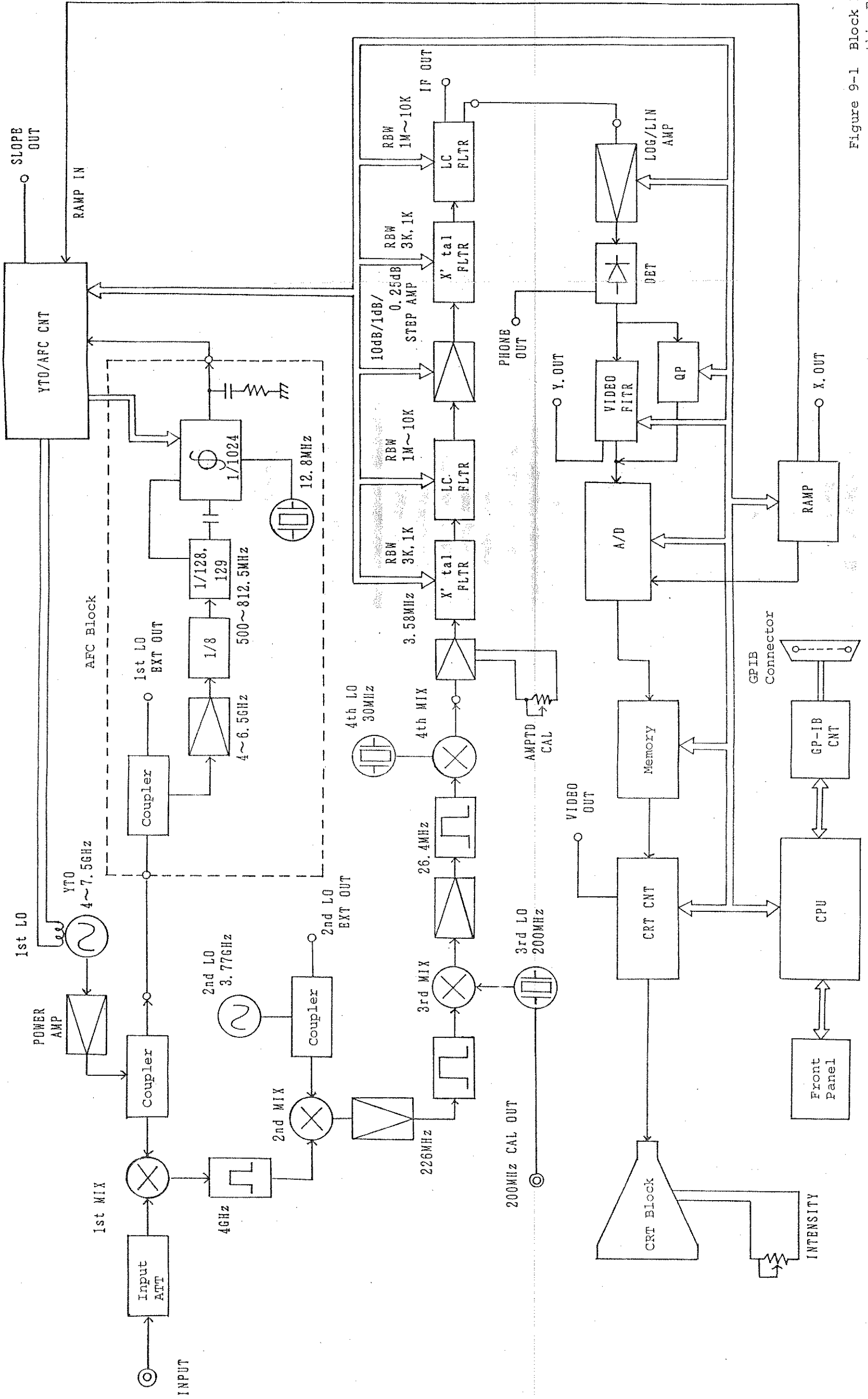

The AFC block encircled with the broken line is added to R4131D/DN only.

Figure 9-1 Block Diagram of this Equipment

9.1.2 R4131 Series Configuration

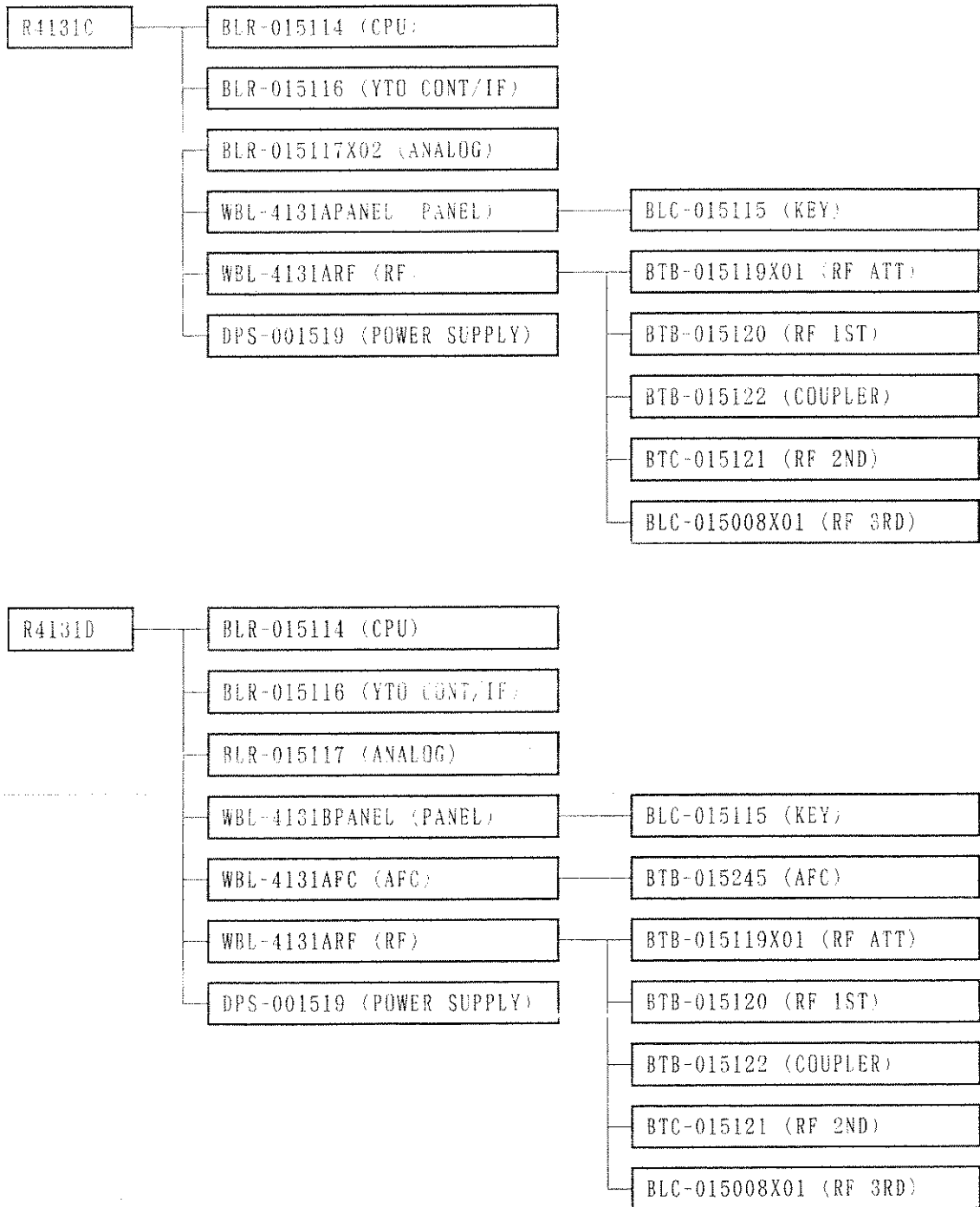

R4131 SERIES
SPECTRUM ANALYZER
INSTRUCTION MANUAL

9.1 Outline

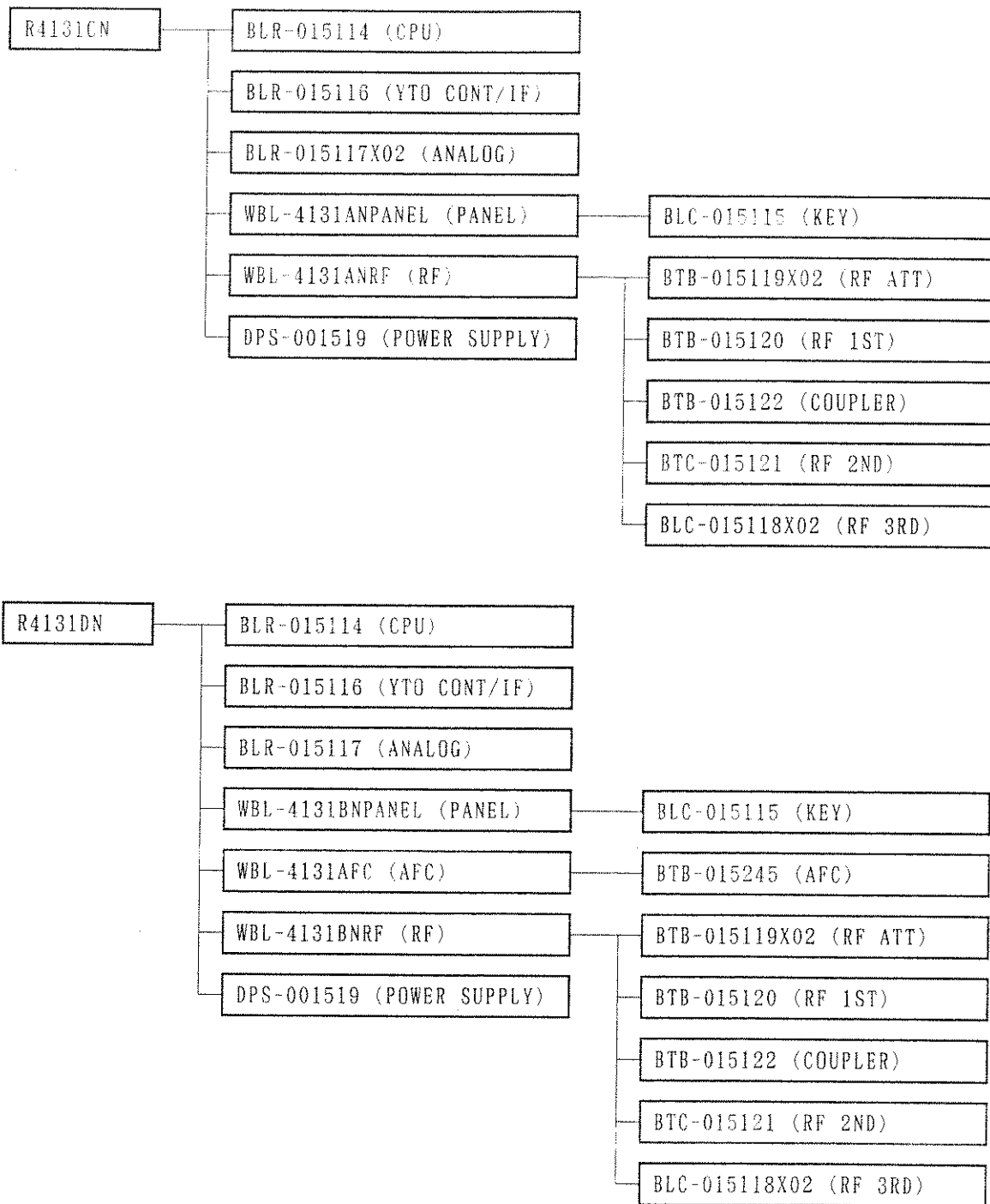

9.2 RF Block

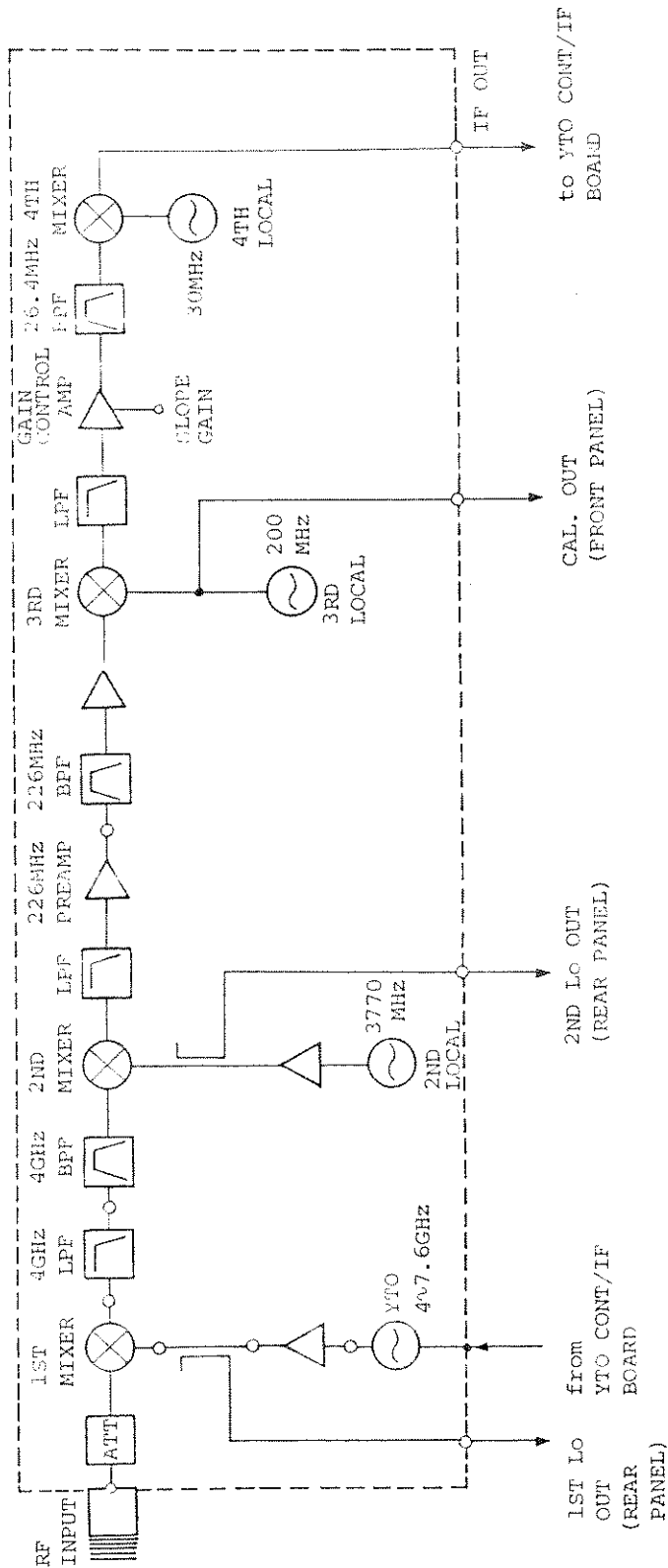

Figure 9-2 RF Block

9.2.1 First Mixer

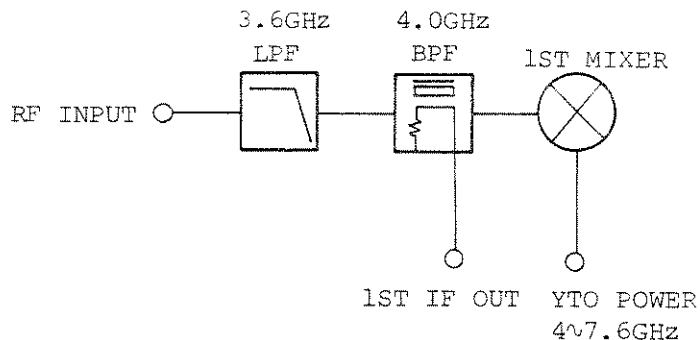

Figure 9-3 First Mixer Block Diagram

(1) 3.6 GHz Low-pass Filter

The 3.6 GHz low-pass filter limits the input frequency band.

(2) 4.0 GHz Band Pass Filter

The 4.0 GHz band pass filter passes only 4 GHz frequency signals of the first IF signals generated by the first mixer.

(3) First Mixer

The first mixer is single-balanced type. It has two ports: one mixes the RF input signals and IF output signals which are isolated by the LPF and BPF in the previous stage.

9.2.2 Second Mixer

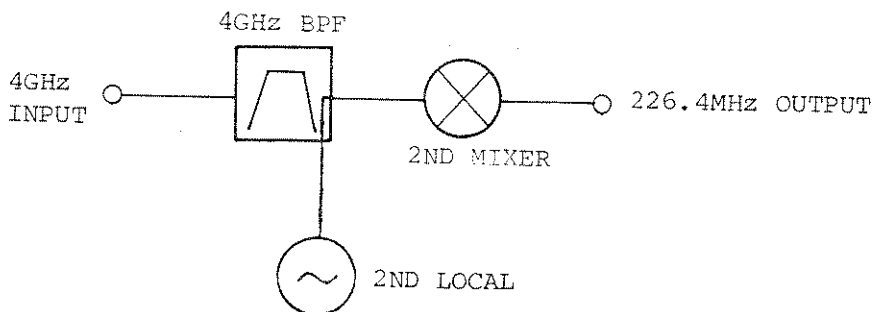

Figure 9-4 Second Mixer Block Diagram

(1) 4.0 GHz Band Pass Filter

The 4.0 GHz band pass filter consists of two dielectric resonators.

(2) Second Local Oscillator

The second local oscillator using a dielectric resonator oscillates the 3770 MHz frequency.

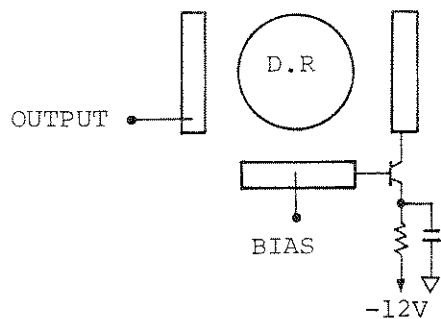

Figure 9-5 Second Local Oscillator

(3) Second Mixer

The second mixer converts the first IF signals (4 GHz) to the second IF signals (226.4 MHz).

9.2.3 Third and Fourth Mixers

The second IF signals (226.4 MHz) are converted to 26.4 MHz (third IF signals) by the third mixer and further converted to 3.58 MHz by the fourth mixer.

The third local oscillator signal is also used as a CAL.OUT signal.

The third IF signal uses a slope signal from the YTO-CONT/IF board to correct the frequency characteristics.

(1) 226.42 MHz Preamplifier

The 226.42 MHz preamplifier has a gain of 20 dB. L3, L4, and C9 are input matching filters. L5, L6, and C13 are output matching filters.

(2) Third Mixer

The third mixer is designed so that it does not input signals outside the band by using the 226.42 MHz BPF. The BPF band width is 4 MHz.

The BPF output is input to the isolation amplifier (Q1) and mixed with 200 MHz signals from the third local oscillator by the third mixer, then converted to 26.4 MHz. The third mixer is a double-balanced type.

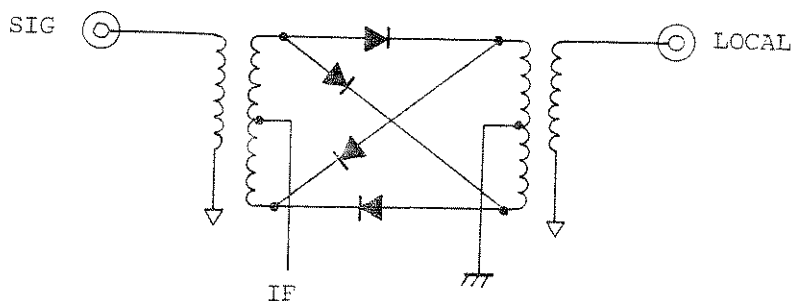

Figure 9-6 Double-balanced Mixer

(3) 200 MHz Crystal Oscillator

The base-ground Colpitts 200 MHz crystal oscillator oscillates a 200 MHz signal. It also oscillates a CAL.OUT signal (200 MHz, -30 dBm).

(4) Gain Control Amplifier

The gain control amplifier changes the resistance of the Q1 emitter and collector to convert the amplifier gain.

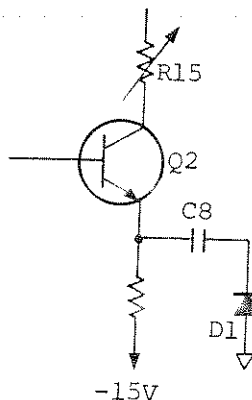

Figure 9-7 Gain Control Amplifier

As the current flowing through the pin diode D1 changes, the resistance changes. Using this characteristic, the gain control amplifier corrects the level. D1 uses a Slope Gain signal to correct the frequency characteristics.

L9 and R20 build a 50-ohm wide band matching circuit so that the gain control amplifier does not affect the 26.4 MHz BPF in later stages.

The 26.4 MHz band pass filter consists of four helical resonators. The circuit converts the signal frequency to 3.58 MHz by the fourth mixer in the next stage. The double-balanced fourth mixer mixes signals by using a 30 MHz signal generated by the fourth local oscillator.

(5) 30 MHz Crystal Oscillator

The Colpitts 30 MHz crystal oscillator oscillates a 30 MHz local signal. The circuit outputs the signal via a tank circuit (C30 and L13) so that it is not changed by the load.

9.3 YTO-CONT/IF Board

9.3.1 IF Filter

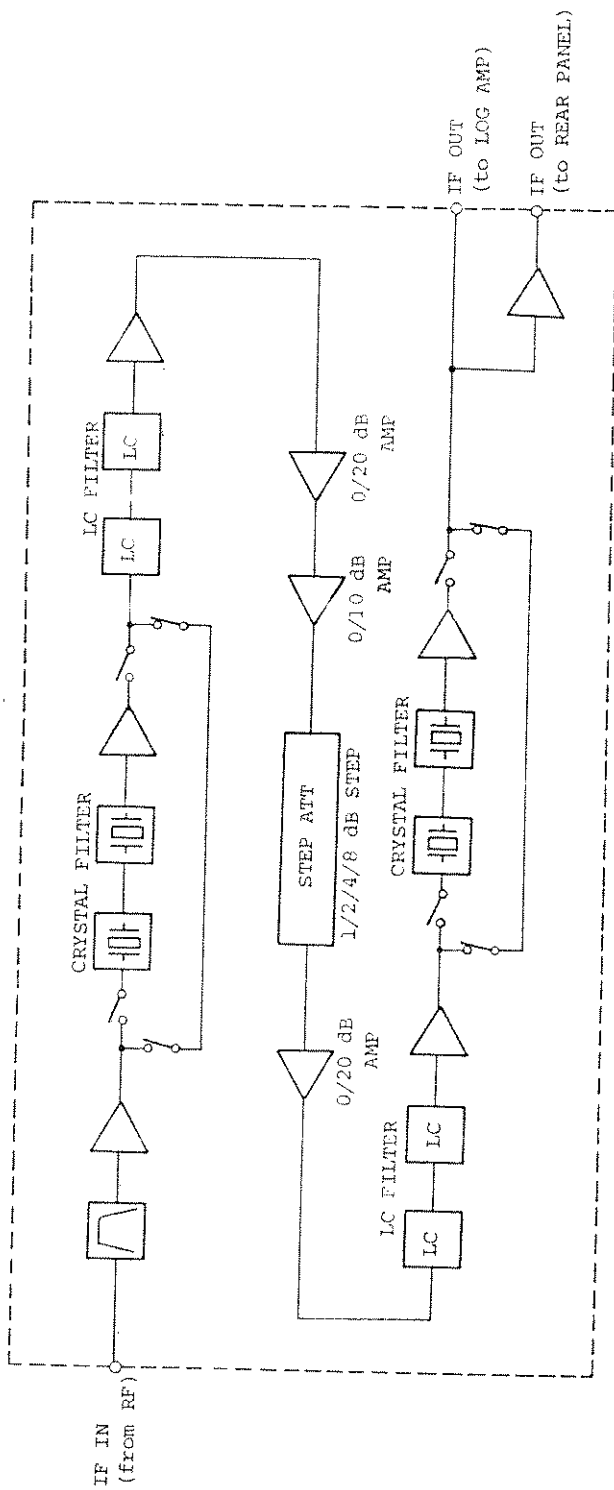

Figure 9-8 IF Filter

The IF filter consists of filters having the resolution bandwidth.

The bandwidth of the filter can be switched by the center frequency of 3.58 MHz according to the setting from the front panel. The filter with narrow bandwidths (1 kHz and 3 kHz) uses four crystal filters; the filter with other bandwidths (1 MHz to 10 kHz) uses four LC filters.

(1) Input 3.58 MHz Band Pass Filter

L2, L3, L4, C2, C3, C4, and C124 form a 3.58 MHz BPF. L1, C1, and R1 form a wide-band impedance matching circuit.

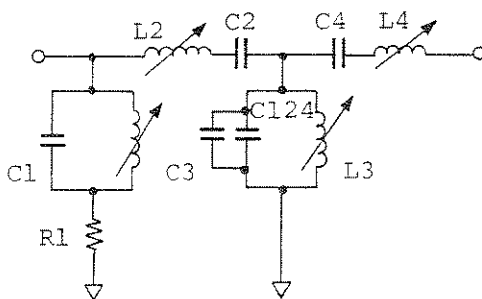

(2) Gain Adjust Amplifier

The gain adjust amplifier is non-inverse type. The circuit changes the total gain by adjusting the variable resistor (AMPTD_CAL) on the front panel.

AMPTD_CAL is used to change the resistance using the FET (Q1) to change the total gain.

R6 is a thermister. It compensates the gain changed by the temperature.

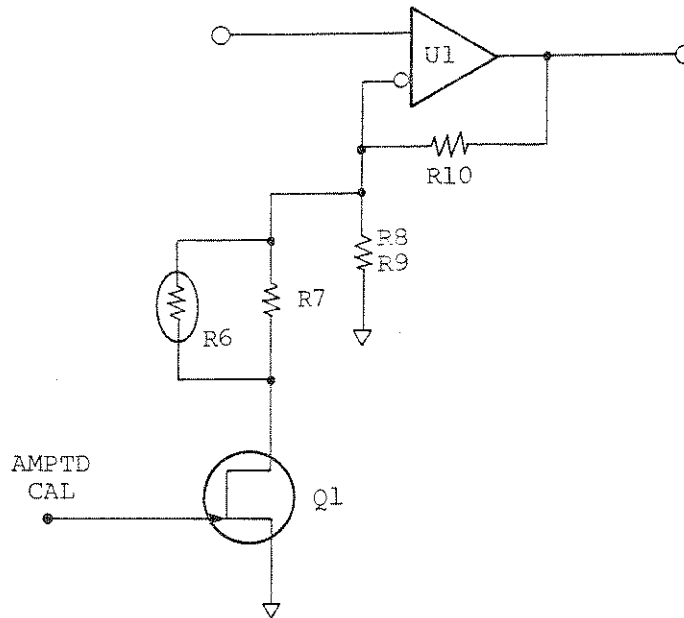

Figure 9-9 Gain Adjust Amplifier

When Q1 = OFF

$$G = 1 + \frac{R10}{R8 + R9} = 1 + \frac{470}{120} = 4.92$$

$$G \text{ (dB)} = 20 \text{ Log}G = 14 \text{ (dB)}$$

When Q1 = ON (10 ohms)

$$G = 1 + \frac{R10}{RT} = 1 + \frac{470}{44.2} = 11.63$$

$$G \text{ (dB)} = 20 \text{ Log}G = 21 \text{ dB}$$

Note: RT is the resistance of R6 to R9 and Q1.

(3) Crystal Filter

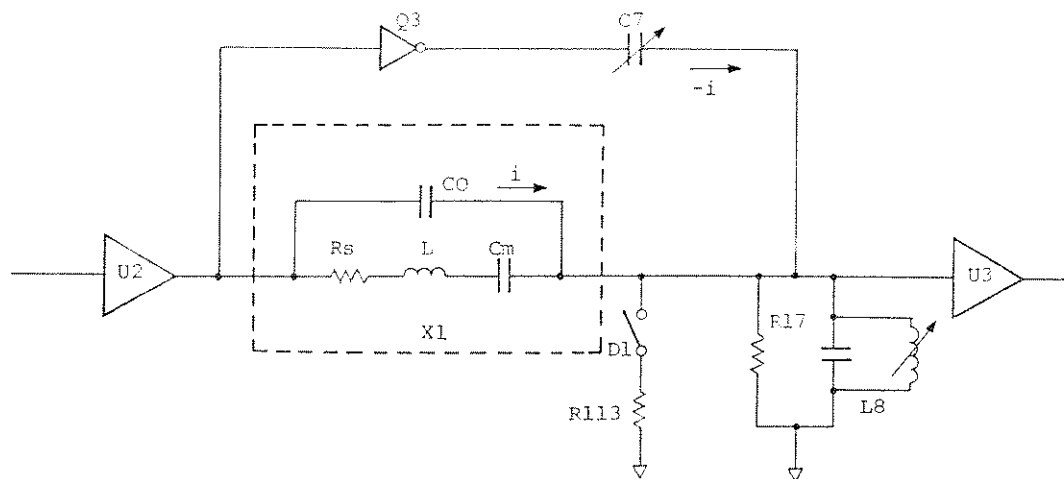

Figure 9-10 Crystal Filter

The bandwidth is selectable with the switch (D1): 1 kHz or 3 kHz. C7 adjusts the symmetry of the filter.

(4) LC Filter

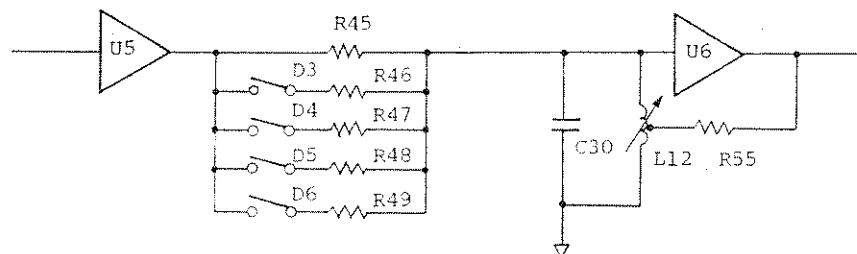

Figure 9-11 LC Filter

The bandwidth is changeable from 10 kHz to 1 MHz by switching the R45 to R49. The bandwidth is narrower as the resistance is larger.

(5) Step Amplifier

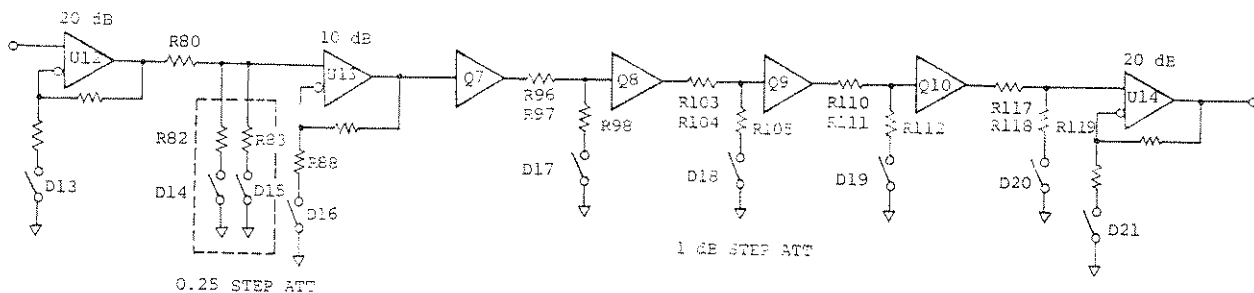

Figure 9-12 Step Amplifier

The step amplifier consists of three step amplifiers (U12 to U14), four 1 dB step attenuators (Q7 to Q10), and a 0.25 dB step attenuator.

U12 and U14 are 0/20 dB step amplifiers and U13 is a 0/10 dB step amplifier.

These step amplifiers and attenuators set the level by steps of 0.25 dB in the range from 0 dB to 59.75 dB.

9.3.2 YTO Controller and AFC

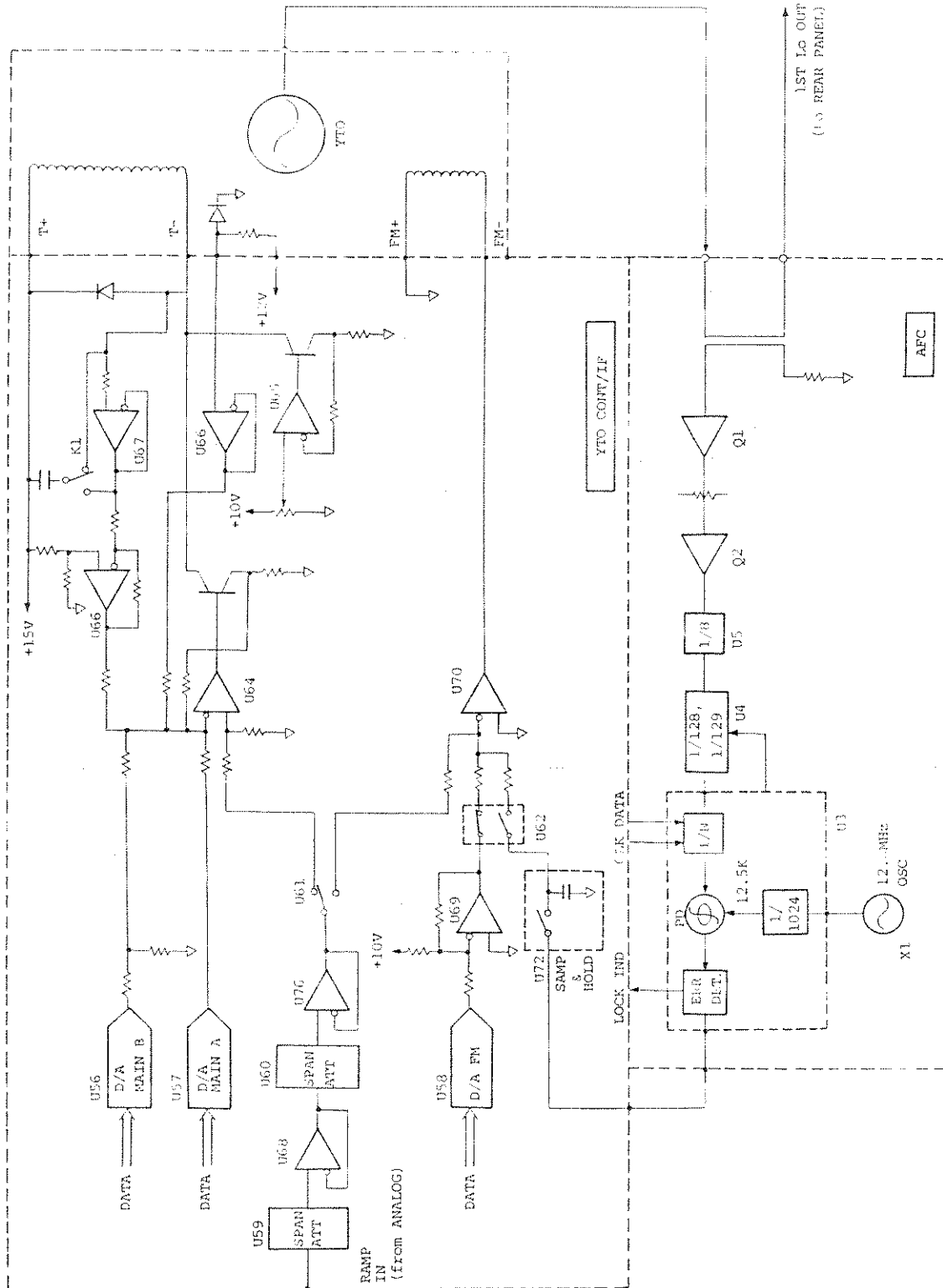

Figure 9-13 YTO Controller & AFC

(1) YTO Controller

The YTO controller consists of a controller and a driver.

The tune voltage changes depending on the set center frequency. The YTO controller sets three digital/analog frequency bands and generates a tune voltage by a combination of the three bands. The three D/A converters have different setting ranges.

Table 9-1 Tune Voltage Data

Tune D/A	Input data	Cent, freq, data	Freq, span
MAIN A (U57)	32 to DE _H	0 to 3.5 GHz	20 MHz to 4.0 GHz
MAIN B (U56)	00 to F9 _H	Δ 25.6 MHz	
FM (U58)	00 to F9 _H	Δ 128 kHz	100 kHz to 10 MHz

For the span voltage, the YTO controller converts the ramp voltage from the ramp generator of the analog board for setting a span by two step attenuators and adds it by the tune voltage in the U64. When the span voltage reaches 10 MHz, a relay (K1) is switched and a noise filter (large-capacity chemical capacitor) is inserted between the main coils. If a charged or discharged current flows through the capacitor, however, the current flowing through the main coil changes, causing a frequency drift. To solve this problem, a charger/discharger is added to charge or discharge at the main T- (See Figure 9-3) even if the noise filter is turned off.

The frequency may also drift because of temperature change. The YTO controller corrects the frequency by the following two methods:

- ① Feeds back the voltages at the both ends of the main coil.

When the current flowing through the main coil is increased or decreased to change the YTO oscillation frequency, the temperature inside the YTO controller changes and causes a frequency drift. Temperature change also causes the main coil resistance. The resistance change can be canceled by feeding back the voltages at both ends of the coil.

- ② Mounts a diode inside the YTO controller and feed back the on-voltage change of the diode to the U64. As the ambient temperature changes, the on-voltage of the diode changes.

Using the above two circuits, the YTO controller reduces frequency drifts without the PLL.

(2) AFC

The AFC mounted on R4131D/DN operates at the frequency span of 200 MHz or smaller and applies AFC to the YTO. The AFC function is available in the band from 0 to 2.5 GHz.

The YTO output (4.0 to 6.5 GHz) is input to the AFC block and converted to the 500 MHz to 812.5 MHz range by the 1/8 divider.

Then, it is compared with the 12.8 MHz oscillation signal by the phase detector and fed back to the tune FM voltage. At this time, if a fault is found in the phase detector output, a pulse is output to the LOCK_IND signal line.

The AFC function is executed between sweeps. During AFC, the span is set to 0 and the SAMP/HOLD circuit is closed. It opens when a sweep starts.

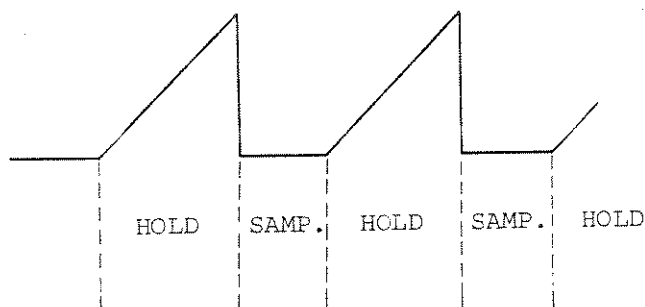

Figure 9-14 SAMP & HOLD

AFC operation sequence is shown below.

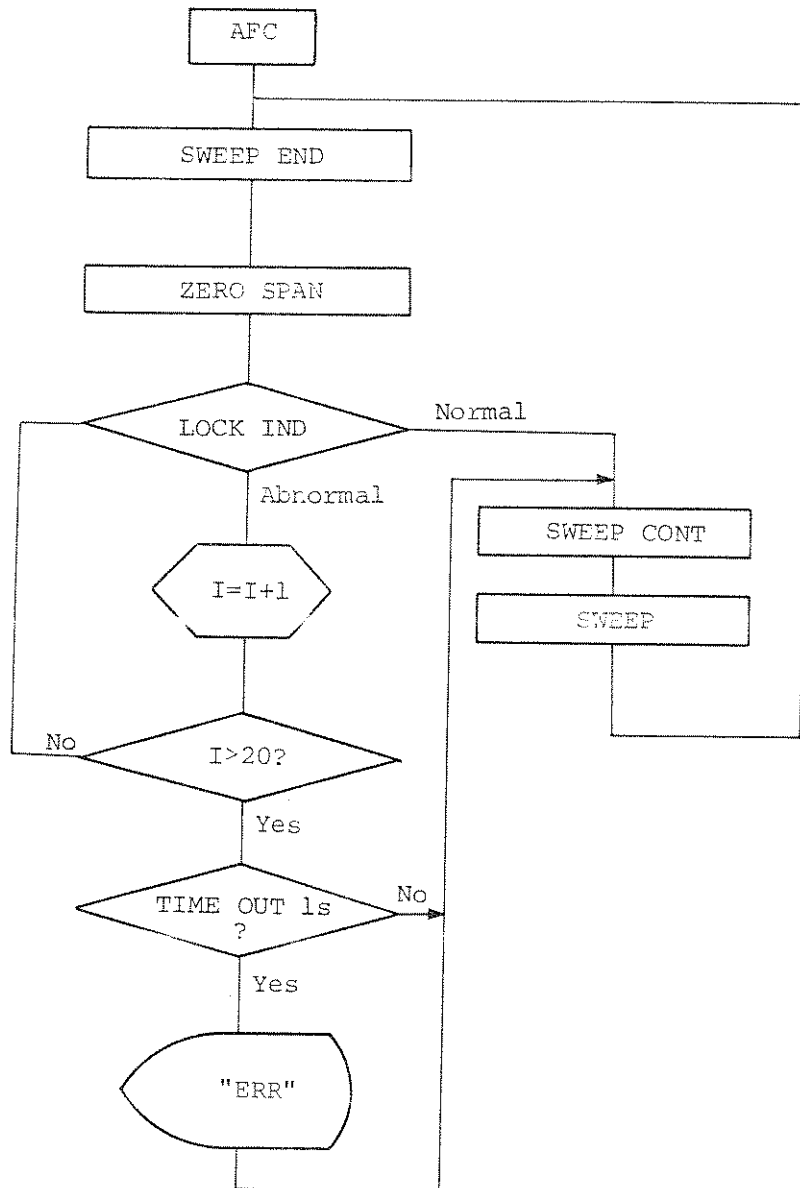

Figure 9-15 Flowchart for AFC

9.4 Analog Board

9.4.1 Log Amplifier

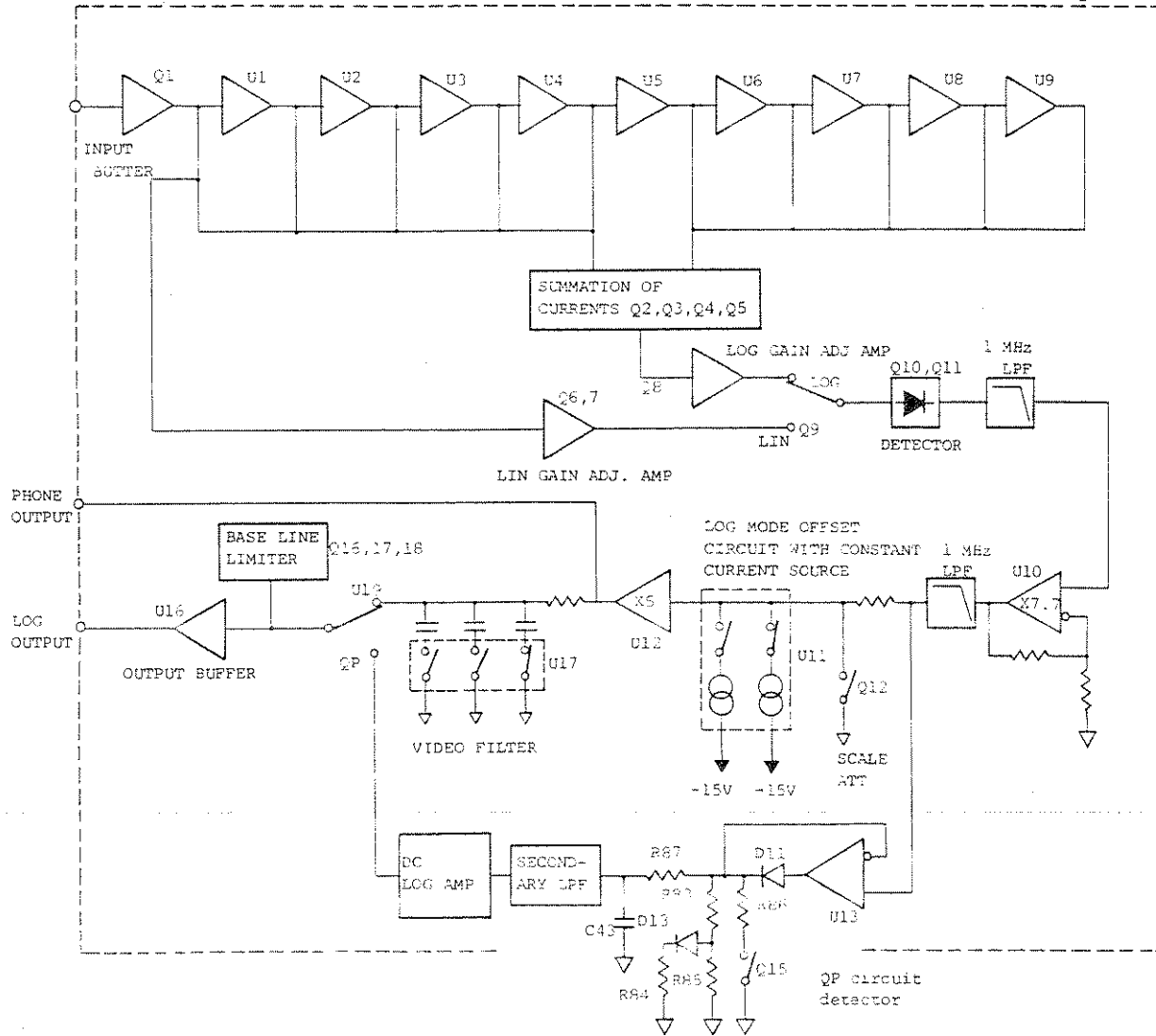
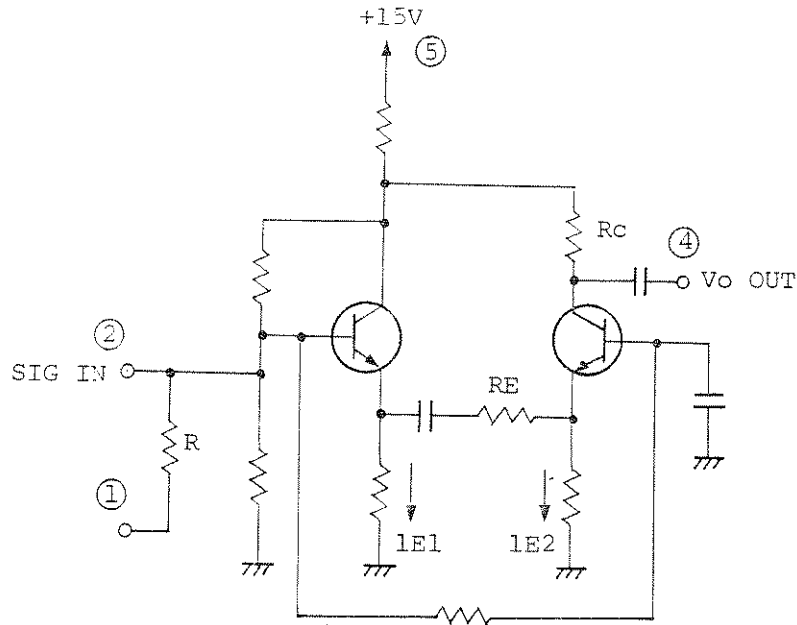

Figure 9-16 Log Amplifier Schematic Diagram

The log amplifier consists of nine saturation amplifiers: each has a gain of 10 dB.

Figure 9-17 shows the saturation amplifier.



$$\text{Gain} = 20 \text{ Log} \frac{R_C}{R_E}$$

$$V_{\text{sat p-p}} = R_C \times (I_{E1} + I_{E2})$$

Figure 9-17 One Stage of 10 dB Amplifier

A signal from the IF block is input to the input buffer (Q1) then to the saturation amplifier. $V_O \text{ OUT}$ is converted to the current V_O/R and input to the current amplifier.

To amplify the current, base-ground amplifiers Q3 and Q4 are used with Q2 and Q3, just as for the bias constant current source.

The current amplified by the base-ground amplifier is converted to the voltage by the R19.

When a 3 Vp-p signal is input to the input buffer (Q1), the 10 dB saturation amplifier output is all 3 Vp-p.

The current amplifier output is found as shown below.

$$V_I = (3/0.62R + 9 \times 3/R) \times R19$$

Assume that $3/R \times R13 = V$.

$$V_I = 10.56 \text{ V}$$

When the input level decreases by 10 dB, the following voltage is output:

$$V_I(-10) = (3/3.16 \times 1/0.62R + 9 \times 3/R) \times R13 = 9.49 \text{ V}$$

Similarly,

$$V_I(-20) = \left(\frac{1}{10} \times \frac{1}{0.62} + \frac{1}{3.16} + 8\right) \text{ V} = 8.47 \text{ V}$$

$$V_I(-30) = \left(\frac{1}{100} \times \frac{1}{0.62} + \frac{1}{10} + \frac{1}{3.16} + 7\right) \text{ V} = 7.43 \text{ V}$$

⋮

$$V_I(-80) = \left(\frac{1}{100} + \frac{1}{10} + \frac{1}{3.16} + 2\right) \text{ V} = 2.43 \text{ V}$$

As shown above, if the input level changes by 10 dB, the output level changes by approximately 1 dB.

The current amplified by the log gain adjust amplifier (Q8) is sent to the base-ground amplifiers (Q10 and Q11) and shaped to half waves for detection. The output is input to the x7.7 amplifier via the LPF, then to the scale attenuator or QP circuit via the 1 MHz LPF.

The scale attenuator sets the vertical axis mode (10 dB/div., 2 dB/div.) by switching the Q12 on/off.

The U11 is a constant current source used to set the offset in logarithms. It is switched according to the horizontal axis mode selected.

The QP circuit detects an envelope by a detector consisting of the U13 and D13 and a discharger consisting of the R84 to R87, D13, and C43.

The D13 and C84 change for each time constant when repetitive frequency goes high or low.

The Q15 is turned off when the bandwidth is 120 kHz and on when it is 9 kHz.

Signals detected by the QP circuit is input to the LPF then to the DC log amplifier consisting of the U15 and U17.

The LOG or LIN/QP modes is set by the switch consisting of the U19 and output via the U16 and output buffer.

9.4.2 Ramp Generator

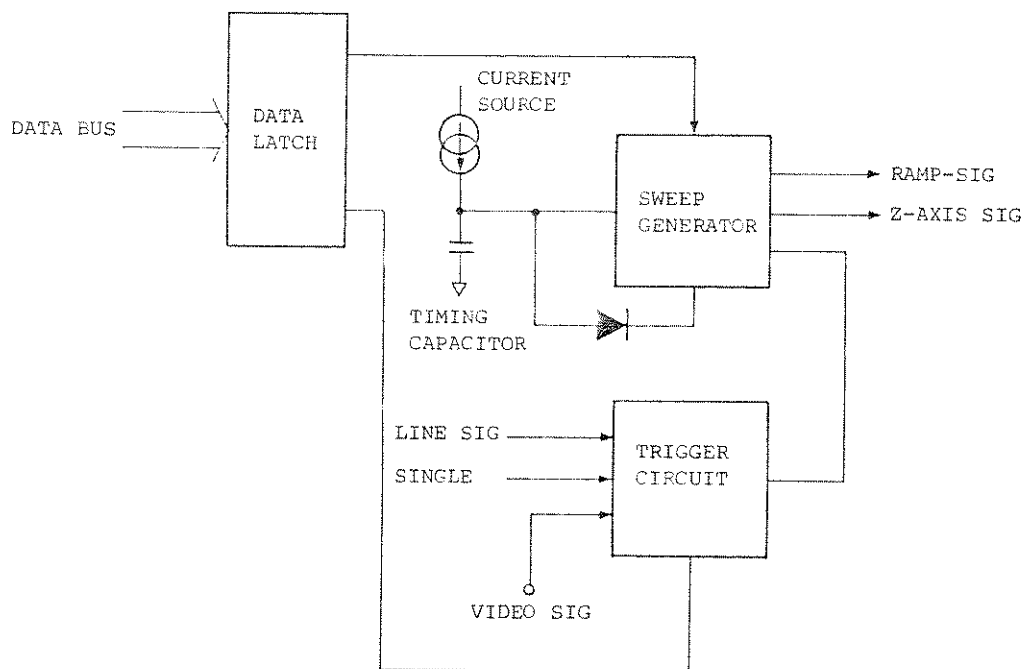

Figure 9-18 Block Diagram

The ramp generator generates a ramp voltage from approximately -5 V to +5 V which is used to sweep the YTO (first local oscillator). The ramp voltage is also used as X-axis data by the A/D converter.

The ramp generator also generates a Z-axis signal which is used to reset the X-axis A/D converter.

The constant current generated from the current source of the ramp generator is applied to the timing capacitor and generates the ramp voltage.

(1) Current Source

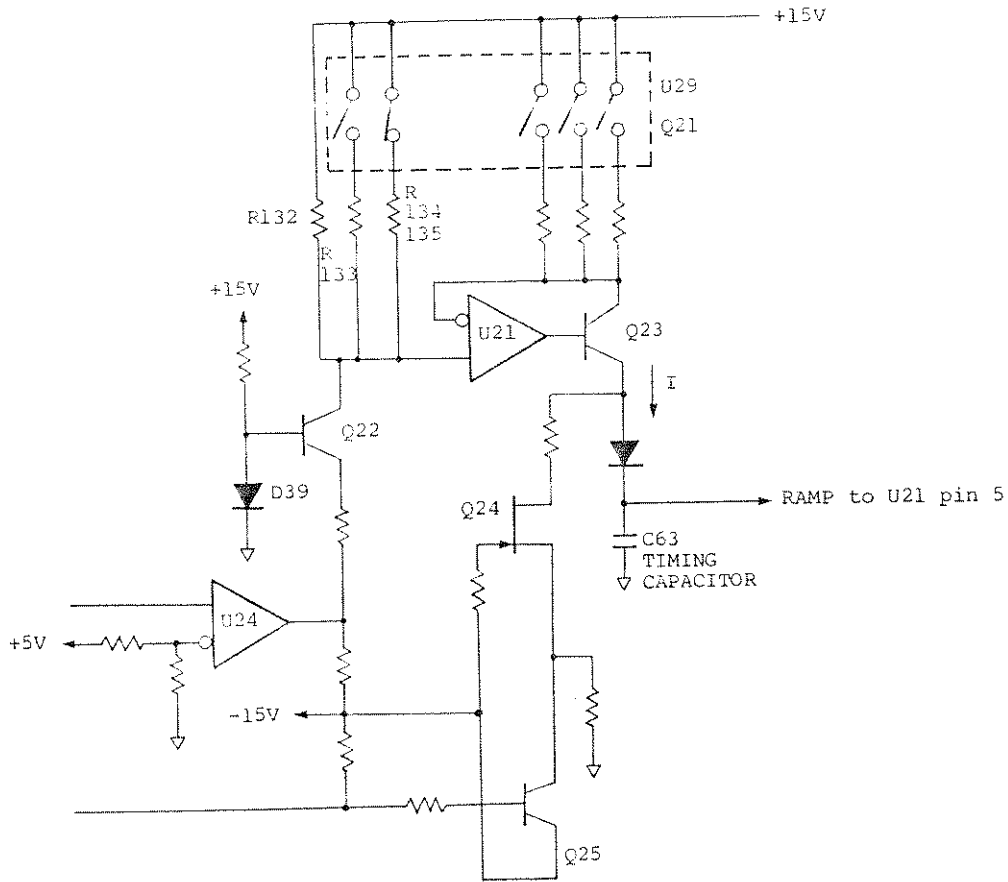

Figure 9-19 Current Source Circuit

The Q22 is a current source that is used to determine the voltage of the U21, pin 5. The voltage is used to correct the temperature of V_{BE} of the Q22.

The voltage of the U21, pin 5 is determined by a combination of the R132 to R135. After the voltage is determined, the emitter current of the Q23 flows until the voltage of the U21, pin 5 is the same as that of the U21, pin 6. The Q23 emitter current is controlled by a combination of the switches (U29 and Q21).

The Q23 collector current is the same as the emitter current because the Q23 current amplifier ratio (h_{fe}) is large.

The constant current determined by the switches (U19 and Q21) flows through the timing capacitor (C63), and then generates a ramp voltage. $v = \frac{1}{C} It$.

The Q24 and Q25 form a sweep stop controller. When a +5 signal is applied to the base of the Q25, the Q24 and Q25 are switched on and all currents flowing through the C63 flow through the Q24 and Q25. At this time, the ramp voltage is in hold state.

(2) Ramp Generator

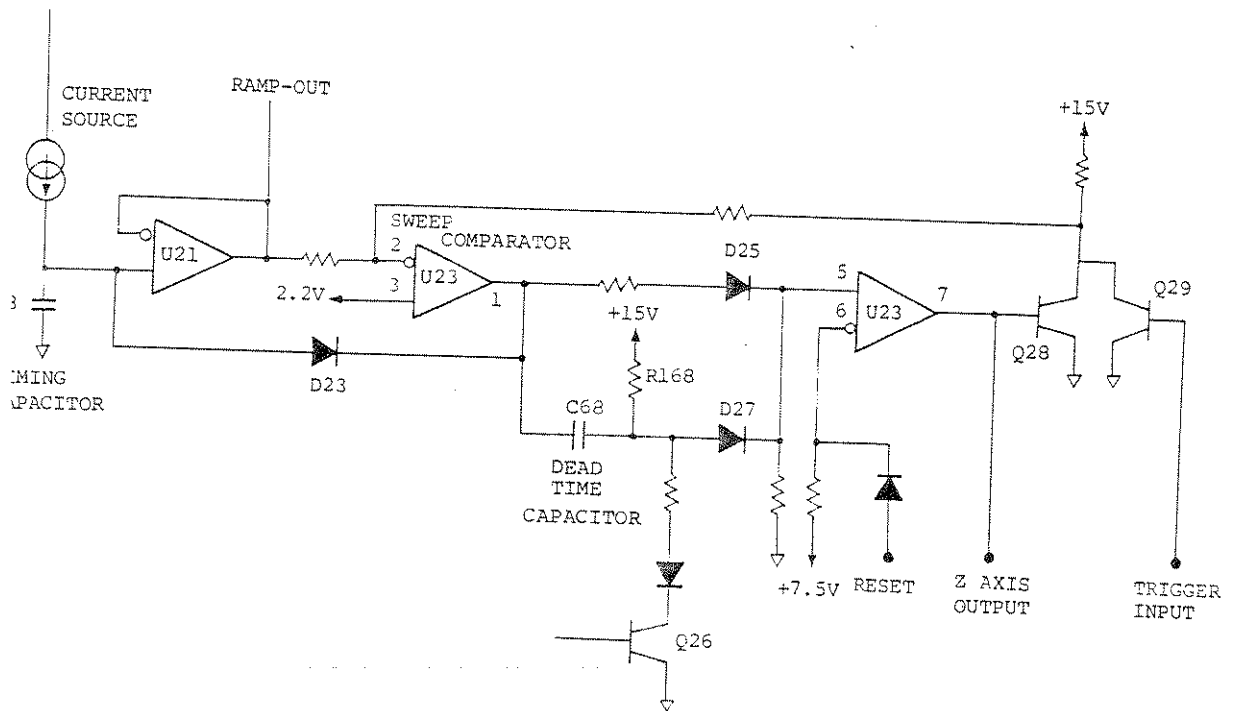

Figure 9-20 Ramp Generator

The ramp voltage from the C63 is input to the sweep comparator U23, pin 2. When the ramp voltage is low, the U23, pin 7 is +15 V and the Q28 is switched on.

When the ramp voltage increases, the voltage of the U23, pin 2 reaches 2.2 V. In other words, when the ramp voltage is 6 V, the U23, pin 1 is inverted and the D25 is switched off. Along with this change, the anode voltage of the D27 also changes via the dead time capacitor. Then, the voltage of the U23, pin 7 becomes -15 V and the Q28 is switched off.

At the same time, the U23, pin 1 is -15 V, the D23 is switched on, and the voltage charged by the C63 is discharged.

When the ramp voltage reaches -6 V, the U23, D23, and U21 form a close loop to keep -6 V. The dead time capacitor (C68) is charged by the R168 because the D27 anode voltage increases. When the voltage of the U23, pin 5 exceeds 7.5 V, the U23, pin 7 becomes +15 V and the Q18 is switched on.

This changes the voltage of the U23, pin 2 and the voltage of the U23, pin 1 to +15 V. The D23 is switched off then the timing capacitor starts charging.

Thus, the ramp generator generates a ramp voltage.

The dead time of the ramp voltage is determined by the R168 and C68. The Q26 is switched on when the trigger mode is set to line, video, or single. Then the D27 anode voltage is set to 7.5 V or less. When the ramp voltage reaches 6 V, the U23, pin 1 is inverted and the Q28 is switched off. When it reaches -6 V, the U23, pin 1 is kept constant.

If the Q29 is switched on by a trigger signal, the voltage of the U23, pin 1 becomes +15 V and the D23 is switched off. Then, the timing capacitor C63 starts charging and a ramp voltage is generated.

9.4.3 A/D Converter

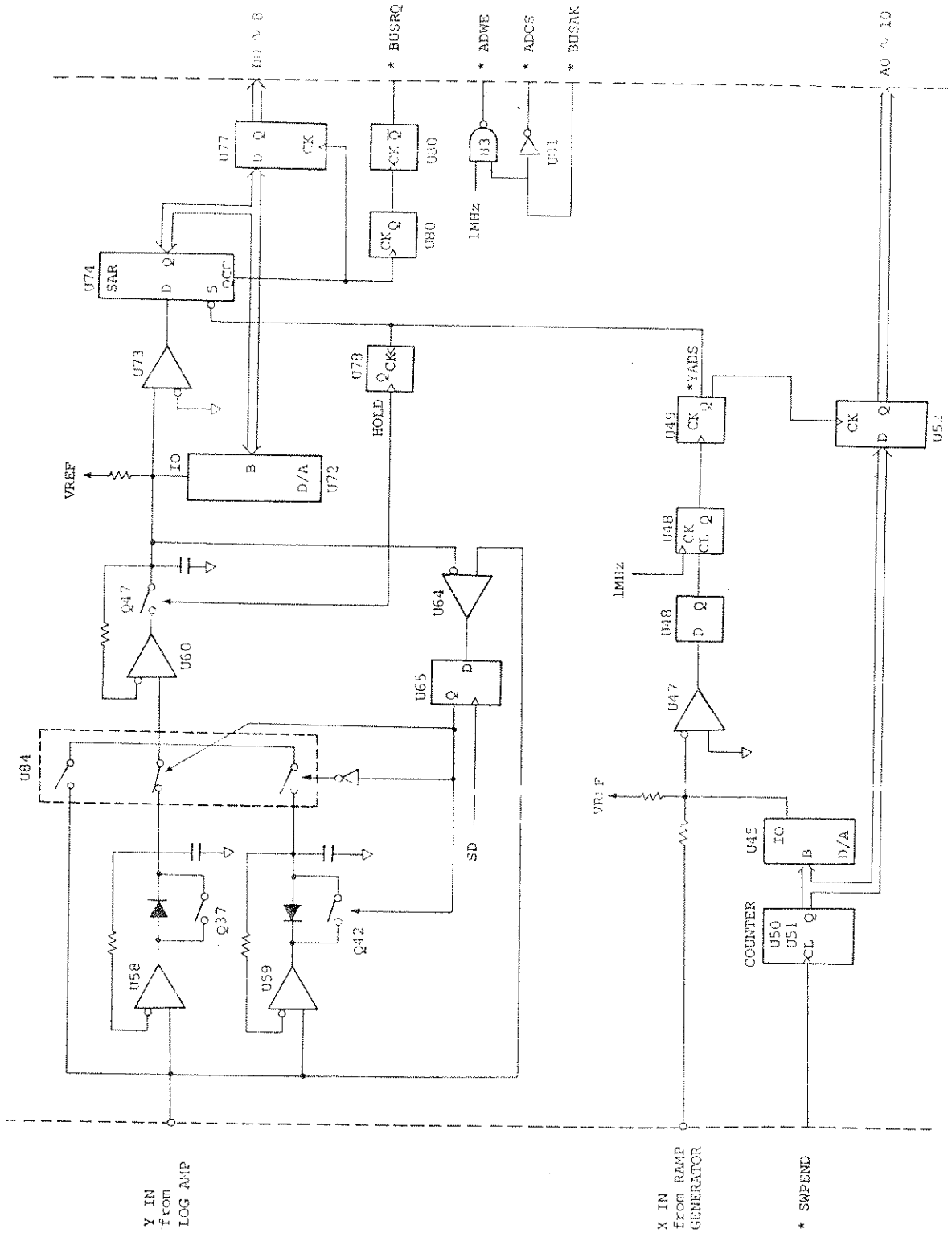

Figure 9-21 A/D Converter

(1) X-axis A/D Converter

The X-axis A/D converter compares the voltage generated by the ramp generator and outputs data from the counter with the D/A converted value. The comparator U47 is inverted when the difference between the current generated by VREF and the current generated by the sweep voltage match the current generated by D/A converter input data. At this time the converter latches the counter and at the same time starts Y-axis A/D by *YADS.

(2) Y-axis A/D Converter

The Y-axis A/D converter converts data analog to digital via the peak detector by the successive approximation for display data.

The peak detector mode is selectable using the input waveform: POSI or NEGA.

When a *YADS signal is input to the U74 from the X-axis A/D converter, the Y-axis A/D converter starts Y-axis A/D conversion and outputs QCC from the SAR (U74) successive comparator. Then, converted Y-axis data is latched by the U77.

The converter issues *BUSRQ to the CPU board. When receiving a *BUSAK signal from the board, it selects the fresh memory on the CPU board by *ADCS and transfers it from the A/D board to the CPU board by a direct memory access (DMA).

When a *ADCS signal is input to the OE terminal of the X-axis and Y-axis latch circuits (U52 and U77), the A/D converter is set to the output mode.

Analyzer Test

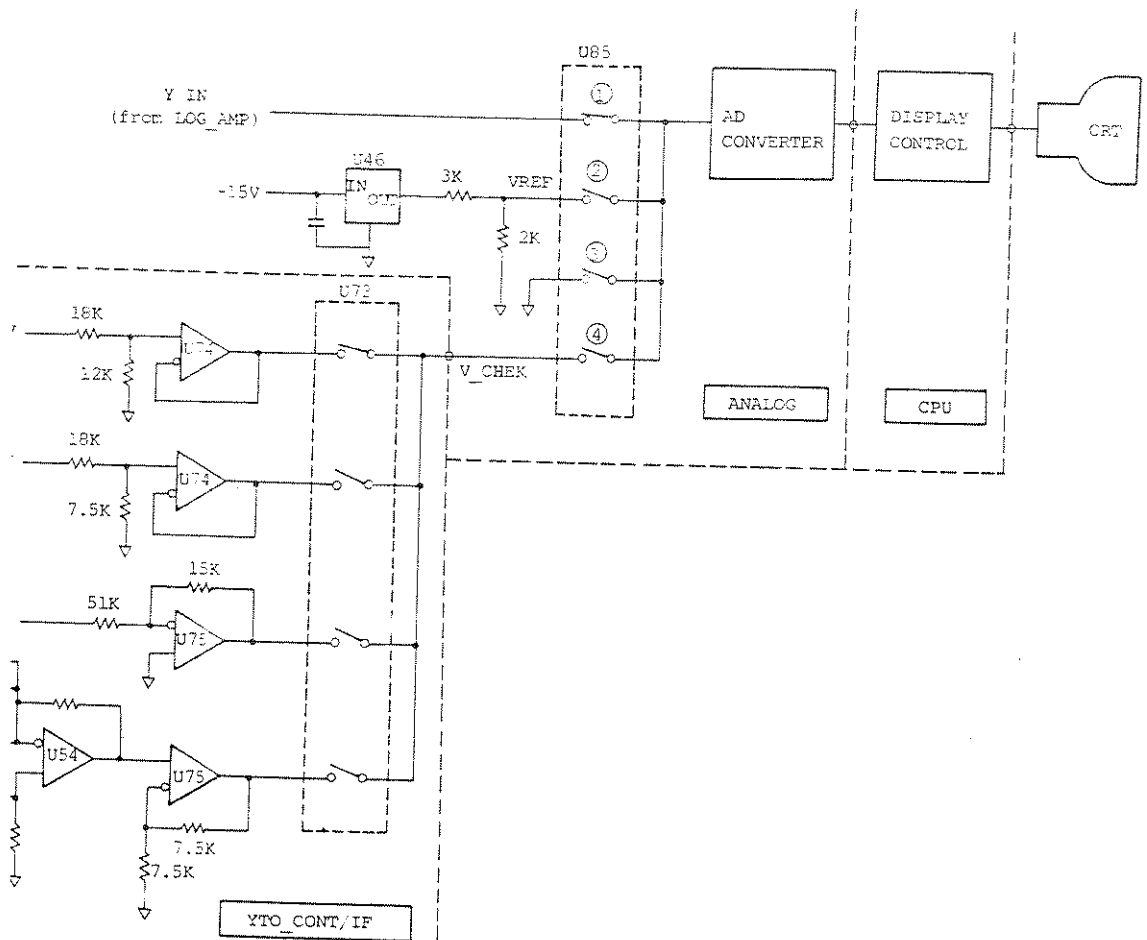

Figure 9-22 Analyzer Test

The R4131 Series has an adjustment function on the screen display. It generates a stable reference voltage and divides it into the 4 V reference voltage. The output is sent to the A/D converter and displayed on the top of the scale. The A/D gain can be adjusted by the 4 V power without DVM. The operator simply aligns the displayed line on the top of the scale. Similarly, adjust the A/D offset by setting the U85 switch to ③ (Figure 9-22) so that the displayed line is on the bottom of the scale.

When the U85 switch is set to ④, the three power sources and slope gain of the YTO CONT/IF board can be tested.

R4131 SERIES
SPECTRUM ANALYZER
INSTRUCTION MANUAL

9.4 Analog Board



These operations can be set by keys. To start the analyzer test mode, press as follows:



The screen shown below appears.

+4 V							
ANALYZER TEST		:	#	Y,OFF			
		:	Y,GAIN				
		:	REF,	+13.5 V			
		:	REF,	-13.5 V			
		:	REF,	+10 V			
		:	SLOPE	0 V			
		:	SLOPE	2 V/GHz			
		QUIT	:	UNIT			
0 V							

Figure 9-23 Analyzer Test Display

Move the mark "#" to the item to be tested with the  and  keys.

MEMO

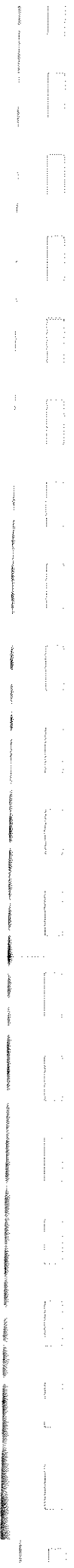

10. CALIBRATION AND ADJUSTMENTS

This section describes the procedures for making basic checks on the R4131 and for calibrating them after performance testing.

MEMO 

R4131 SERIES
SPECTRUM ANALYZER
INSTRUCTION MANUAL

10. Calibration and Adjustments

10. CALIBRATION AND ADJUSTMENTS

This section describes the procedures for making basic checks on the R4131 and for calibrating them after performance testing.

R4131 SERIES
SPECTRUM ANALYZER
INSTRUCTION MANUAL

10.1 Preparation

10.1 Preparation

Table 10-1 lists the equipment and tools required for calibration and adjustment. Use equipment and tools equivalent or superior in performance to these.

Table 10-1 Equipment and Tools Required for Calibration and Adjustment

Equipment	Performance	Recommended equipment
Digital voltmeter	Range : ± 1000 V Accuracy : $\pm 0.1\%$ Input impedance: $10\text{ M}\Omega$	TR6846 (Voltage adjustment)
Synthesized signal generator	Frequency range : Frequency accuracy:	TR4511 Adjustment for YTO CONT/IF
10 dB step attenuator	Frequency range: DC to 500 MHz Variable : 0 to 80 dB or more Accuracy : ± 0.5 dB or less	Adjustment for LOG AMP
1 dB step attenuator	Frequency range: DC to 500 MHz Variable : 0 to 10 or more Accuracy : ± 0.2 dB or less	Adjustment for LOG AMP
Spectrum analyzer	Frequency range : 10 MHz to 4 GHz Frequency accuracy: ± 100 kHz	R4136 Adjustment for RF
Spectrum analyzer	Frequency range : 10 Hz to 120 MHz Tracking generator output: 10 Hz to 120 MHz T.G. output flatness : ± 1 dB Impedance : $50\ \Omega$ and $1\text{ M}\Omega$	TR4171 or R4136 + TR4154 Adjustment for IF FILTER

Table 10-2 Maintenance Tools Required for Calibration and Adjustment

Product name	Stock number	Remarks
Cable (SMA-SMA)	MM-14	
Cable (BNC-UM)	MC-36	2 pcs.
Cable (BNC-BNC)	MI-02	
UM to UM linear adapter	JCF-AC001JX07-1	UM-QA-JJ

(1) Notes on Adjustment

Before adjustment, performs the following operations:

- ① Before setting the Power switch to OFF, press ^{SHIFT} and ^{LCL}.

This operation sets correct data set by the CPU to zeros when ZERO CAL is executed.

Corrected data is not erased even if the power is switched off. To reset correction, press these keys again.

- ② Adjust the R4131D/DN having the AFC function as follows:

- Set the Power switch to ON while the ^{START/RESET} key is pressed down.
- The message "strike any key" appears on the screen.
- Press the ^{TRIGGER} key and the following screen appears:

```
<TYPE>:#R4131C (50)
        R4131D (50) (AFC)
        R4131CN (75)
        R4131DN (75) (AFC)

<OPTION>: OBW ON
```

- Move the mark "#" to the R4131C or R4131CN with the ^{TIME/DIV} keys.

```
R4131D → R4131C
R4131DN → R4131CN
```

- Press the ^{TRIGGER} key.
- Adjust the values.
- Return setting to the original type.

```
R4131C → R4131D
R4131CN → R4131DN
```

10.2 A/D Adjustment (Analog Board) (BLR-015117)

- ① Measure the voltage between the TP19 and TP1 (GND) by the DMM and remember the measured value (V_{TP19}).
- ② Adjust the variable resistors so that the voltages of the TP20, TP21, and TP22 are as shown in Table 10-3. (This adjustment is available for the R4131D/DN only.)

Table 10-3 TP20, TP21, TP22 Voltage Adjustment Values

TP	Voltage	VR
TP20	$V_{TP19} \pm 10 \text{ mV}$	R241
TP21		R258
TP22		R277

- ③ Press SHIFT, START, and SWT.
- ④ The following data appears on the screen display:

+4 V									
ANALYZER TEST		:	#	Y,OFF					
		:	Y,GAIN						
		:	REF,	+13.5 V					
		:	REF,	-13.5 V					
		:	REF,	+10 V					
		:	SLOPE	0 V					
		:	SLOPE	2 V/GHz					
	QUIT	:	UNIT						
0 V									

- ⑤ Move the mark "#" to Y.OFF with the ↓ and ↑ keys.
- ⑥ Adjust the R308 so that the displayed line aligns with the bottom line on the scale.
- ⑦ Similarly, move the mark "#" to Y.GAIN with the ↓ and ↑ keys.

R4131 SERIES
SPECTRUM ANALYZER
INSTRUCTION MANUAL

10.2 A/D Adjustment (Analog Board)
(BLR-015117)

- ⑧ Adjust the R310 so that the displayed line aligns with the top line on the scale.
- ⑨ Press the UNITS key to initialize the R4131.
- ⑩ Set the local feed-through to the center of the screen at the span 20 MHz.
- ⑪ If the local feed-through is not at the center when the span is returned to 4 GHz, adjust the R233 so that it comes to the center. (X-axis and position adjustment)
- ⑫ Set the local feed-through at the center of the screen and change the span to 1 MHz and RBW to 30 kHz.
- ⑬ Set the display detection mode to POSI with the SHIFT and POS PK DET keys.
- ⑭ Adjust the R296 so that the waveforms are smoothed.
- ⑮ Set the display detection mode from POSI to NEGA with the SHIFT and NORMAL DET keys.
- ⑯ Adjust the R302 so that waveforms are smoothed.

10.3 LOG Amplifier Adjustment (Analog Board) (BLR-015117)

- ① Disconnect the UM cable from the J4 and press ^{SHIFT} and _{LINEAR} to set the X-axis to the linear mode.
- ② Adjust the R57 and R72 so that voltage of the TP13 and TP14 is within ± 1 mV.

	Voltage	VR
TP.13	± 1 mV	R57
TP.25		R72

- ③ Connect the log amplifier as shown in Figure 10-1.
- ④ Set the signal generator as follows:

Frequency: 3.5789 MHz
Amplitude: -1 dBm

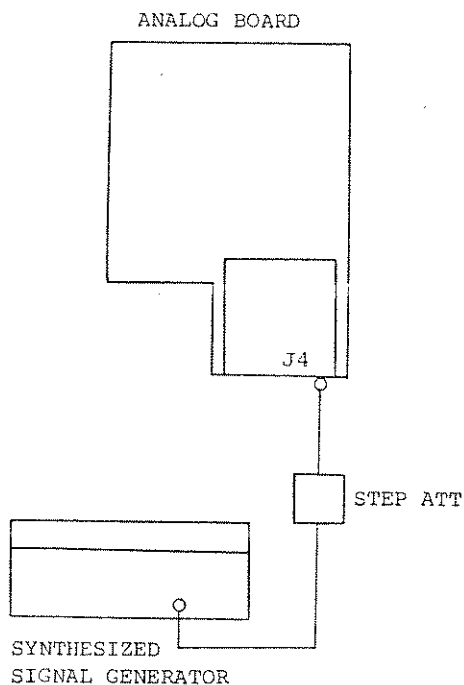

Figure 10-1 Log Amplifier Adjustment

R4131 SERIES
SPECTRUM ANALYZER
INSTRUCTION MANUAL

10.3 LOG Amplifier Adjustment (Analog Board)

(BLR-015117)

- ⑤ Set the R4131 as follows:

Frequency span: 1 GHz
10 dB/DIV

- ⑥ Set the step attenuator to 0 dB.
- ⑦ Adjust the R40 so that the waveform aligns with the top line on the scale.
- ⑧ Set the step attenuator to 70 dB.
- ⑨ Adjust the R69 so that the waveform aligns with the second line from the bottom on the scale.
- ⑩ Repeat steps ⑥ to ⑨.
- ⑪ Set the R4131 to 2 dB/div.
- ⑫ Set the step attenuator to 0 dB.
- ⑬ Adjust the R65 so that the waveform aligns with the top line on the scale.
- ⑭ Set the R4131 to LINEAR.
- ⑮ Adjust the R38 so that the waveform aligns with the top line on the scale.
- ⑯ Set the R4131 to QP.
- ⑰ Adjust the R109 so that the waveform aligns with the top line on the scale.
- ⑱ Set the step attenuator to 20 dB.
- ⑲ Adjust the R102 so that the waveform aligns with the middle line on the scale.
- ⑳ Set the step attenuator to 35 dB.
- ㉑ Adjust the R96 so that the waveform aligns with the second line from the bottom on the scale.
- ㉒ Repeat steps ⑰ to ㉑.

10.4 IF Filter Adjustment (YTO-CONT/IF Board)

10.4.1 3.58 MHz BPF Adjustment

- ① Set the TR4171 as follows:

INPUT IMPEDANCE : 1 MΩ
MAG mode
CENTER FREQ. : 3.5795 MHz
FREQ. SPAN : 5 MHz
REF. LEVEL : -30 dBm
TG LEVEL : -10 dBm
1 dB/DIV.

- ② Connect the units as shown in Figure 10-2.

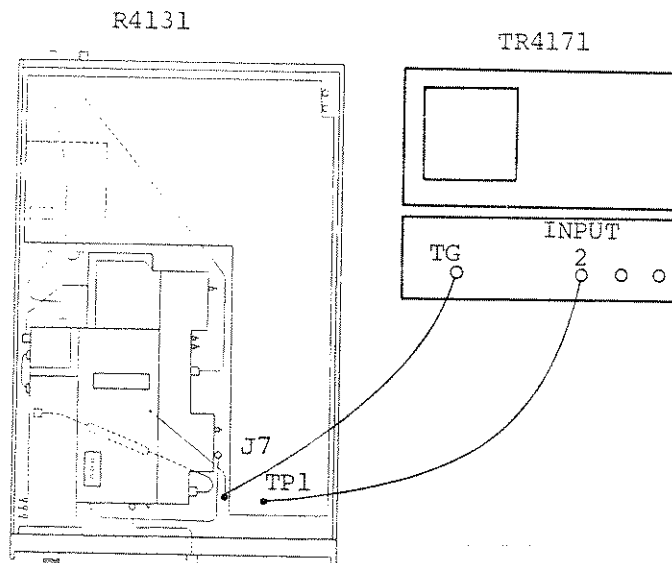

Figure 10-2 3.58 MHz BPF Adjustment

- ③ Turn the core of the L1 to L4 to adjust the waveform so that its peak is at 3.5789 MHz.

R4131 SERIES
SPECTRUM ANALYZER
INSTRUCTION MANUAL

10.4 IF Filter Adjustment (YTO-CONT/IF
Board)

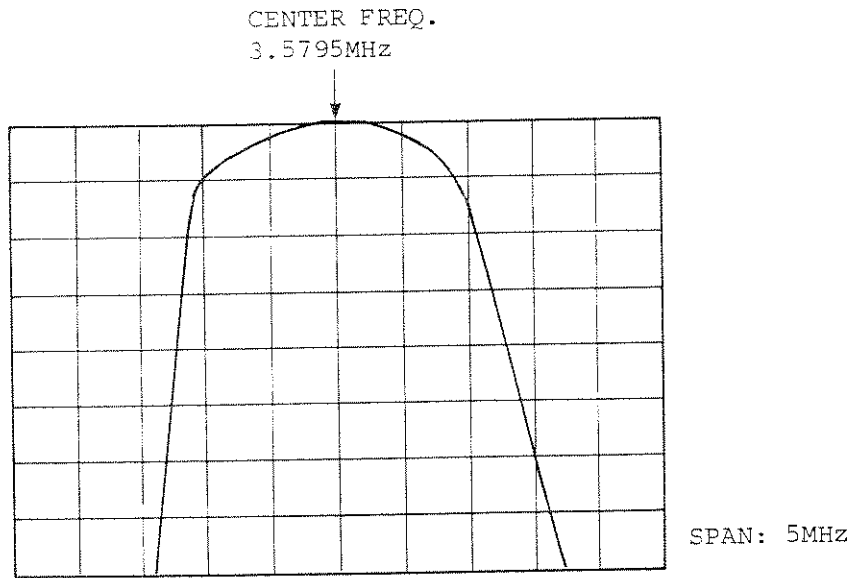

Figure 10-3 Waveform of 3.58 MHz BPF

10.4.2 Crystal Filter Adjustment

- ① Connect the units as shown in Figure 10-4.

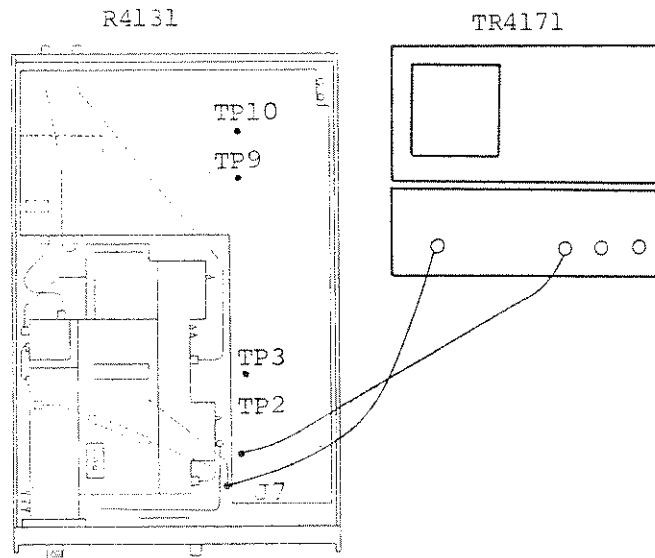

Figure 10-4 Crystal Filter Adjustment

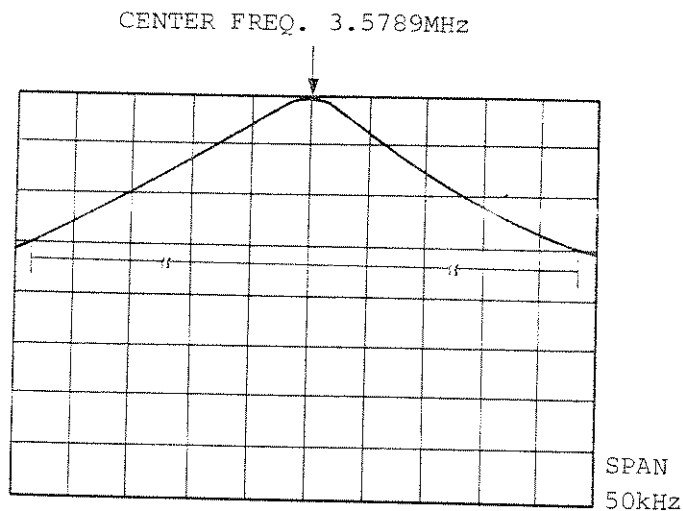

Figure 10-5 Waveform of Crystal Filter

- ② Set the TR4171 as follows:
 CENTER FREQ.: 3.5795 MHz
 FREQ. SPAN : 50 kHz
 10 dB/DIV.
- ③ Set the R4131 as follows:
 RBW: 3 kHz
- ④ Connect the TP1 with the INPUT2 of the TR4171 and adjust the C9 so that the waveform is symmetrical. Then adjust the L8 so that the peak of the waveform is at its lowest level.
- ⑤ Connect the TP2 with the INPUT2 of the TR4171 and adjust the C18 so that the waveform is symmetrical. Then adjust the L10 so that the peak of the waveform is at its lowest level.
- ⑥ Press RBW, SHIFT, INPUT ATTENUATOR and set the R4131 as follows:
 RBW: QP
 BW : 9 kHz
- ⑦ Connect the TP9 with the INPUT2 of the TR4171 and adjust the C99 so that the waveform is symmetrical. Adjust the L27 so that the peak of the waveform is at its lowest level.
- ⑧ Connect the TP10 with the INPUT2 of the TR4171 and adjust the C108 so that the waveform is symmetrical. Adjust the L28 so that the peak of the waveform is at its lowest level.

R4131 SERIES
SPECTRUM ANALYZER
INSTRUCTION MANUAL

10.4 IF Filter Adjustment (YTO-CONT/IF
Board)

- ⑨ Adjust the L29 so that the waveform is at its maximum size.

10.4.3 LC Filter Adjustment

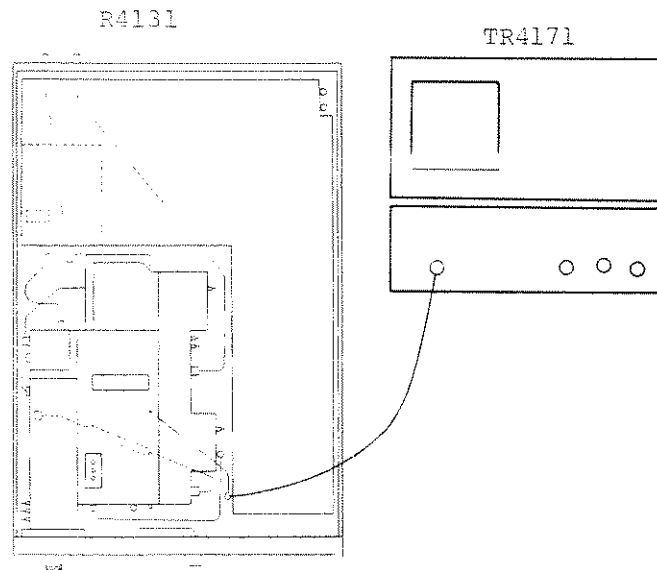

Figure 10-6 LC Filter Adjustment

- ① Set the TR4171 as follows:
- CENTER FREQ.: 3.5789 MHz
FREQ. SPAN : 100 kHz
2 dB/DIV.
- ② Set the R4131 as follows:
- RBW: 10 kHz
- ③ Connect the TP4 with the INPUT2 of the TR4171 and adjust REF.LEVEL so that the waveform appears on the screen.
- ④ Adjust the L12 so that the waveform aligns with the center frequency.
- ⑤ Connect a probe to the TP5 and adjust REF.LEVEL so that the waveform appears on the screen.
- ⑥ Adjust the L13 so that the waveform aligns with the center frequency.
- ⑦ Connect a probe to the TP7 and adjust REF.LEVEL of the TR4171 so that the waveform appears on the screen.

- ⑧ Adjust the L23 so that the waveform aligns with the center frequency.
- ⑨ Connect a probe to the TP8 and adjust REF.LEVEL of the TR4171 so that the waveform appears on the screen.
- ⑩ Adjust the L24 so that the waveform aligns with the center frequency.

10.4.4 Resolution Bandwidth Level Adjustment

- ① Connect the TP5 with the INPUT2 of the TR4171.
- ② Set the TR4171 as follows:
CENTER FREQ.: 3.5795 MHz
FREQ. SPAN : 100 kHz
2 dB/DIV.
- ③ Set the R4131 as follows:
RBW: 300 kHz
- ④ Adjust REF.LEVEL so that the waveform positions at the center on the scale of the TR4171 and store the waveform.
- ⑤ Set the R4131 as follows:
RBW: 10 kHz
- ⑥ Adjust the R67 so that RBW is set to the same level as at 300 kHz.
- ⑦ Set the R4131 as follows:
RBW: 3 kHz
- ⑧ Adjust the R35 so that RBW is set to the same level as at 300 kHz.
- ⑨ Connect the J8 with the INPUT2 of the TR4171.
- ⑩ Set the R4131 as follows:
RBW: 300 kHz
- ⑪ Adjust REF.LEVEL so that the waveform positions at the center on the scale of the TR4171 and store the waveform.
- ⑫ Set the R4131 as follows:
RBW: 10 kHz
- ⑬ Adjust the R141 so that RBW is set to the same level as at 300 kHz.

- ⑭ Set the R4131 as follows:

RBW: 3 kHz

- ⑮ Adjust the R184 so that RBW is set to the same level at 300 kHz.

10.4.5 Step Amplifier Adjustment

- ① Connect the units as shown in Figure 10-7.

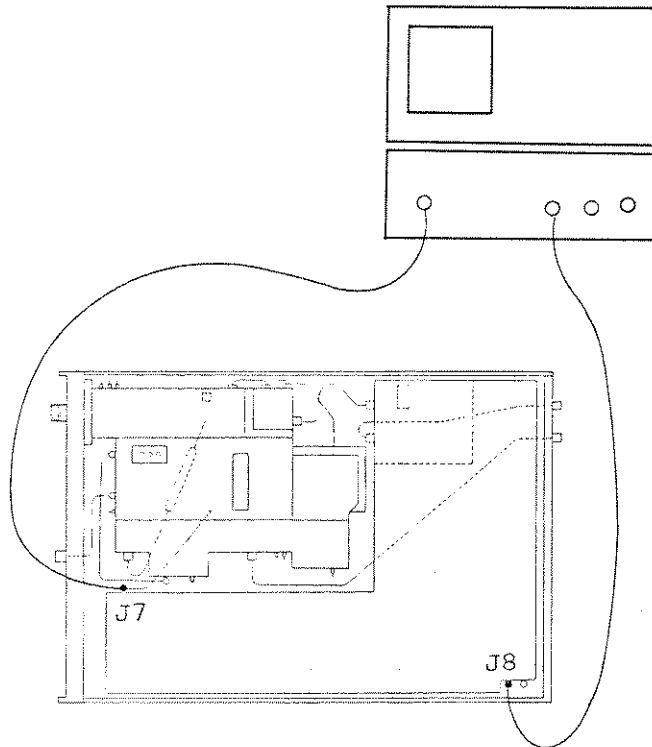

Figure 10-7 Step AMP Adjustment

- ② Set the R4131 as follows:

RBW: 300 kHz

- ③ Set the TR4171 as follows:

CENTER FREQ.: 3.5789 MHz
FREQ. SPAN : 200 kHz
REF. LEVEL : -10 dBm
TG LEVEL : -30 dBm
1 dB/DIV.

- ④ Set and adjust R4131 REF.LEVEL and external ATT as shown in Table 10-4 using the R4131 REF.LEVEL as reference.

Table 10-4 Step Amplifier Adjustment

REF.LEVEL	0 dBm	-10 dBm	-20 dBm	-30 dBm	-40 dBm	-50 dBm
External ATT value	0 dB	10 dB	20 dB	30 dB	40 dB	50 dB
VR to be adjusted	Reference	R89	R75	Check	R123	Check

R4131 SERIES
SPECTRUM ANALYZER
INSTRUCTION MANUAL

10.5 YTO-CONT Adjustment (YTO-CONT/IF Board)

(BLR-015116)

10.5 YTO-CONT Adjustment (YTO-CONT/IF Board) (BLR-015116)

- ① Press ^{SHIFT}, ^{LCL}, and set the Power switch to OFF. Then set the Power switch to ON and press ^{SHIFT}, ^{UNIT OFFSET}, and ^{UNIT}.
- ② The following data appears on the screen display:

+4 V									
ANALYZER TEST : #Y,OFF									
: Y,GAIN									
: REF,+13.5 V									
: REF,-13.5 V									
: REF,+10 V									
: SLOPE 0 V									
: SLOPE 2 V/GHz									
QUIT : UNIT									
0 V									

Figure 10-8 Analyzer Test Display

- ③ Move the mark "#" to REF.+10 V with the [↓] and [↑] keys.
- ④ Adjust the R232 so that the displayed line aligns the top line on the scale.
- ⑤ Move the mark "#" to REF.-13.5 V with the [↓] and [↑] keys.
- ⑥ Adjust the R240 so that the displayed line aligns the top line on the scale.
- ⑦ Move the mark "#" to REF.+13 V with the [↓] and [↑] keys.
- ⑧ Check whether the displayed line is almost overlapped on the top line on the scale.
- ⑨ Set the offset of the R4131 as follows:
 CENTER FREQ.: 0 MHz
 FREQ. SPAN : 20 MHz
- ⑩ Set the local feed-through to the center of the screen by the encoder.
- ⑪ Adjust the R355 so that the local feed-through does not shift horizontally even if the frequency span is set to 10 MHz.

⑫ Main Span

Connect the units as shown in Figure 10-9.

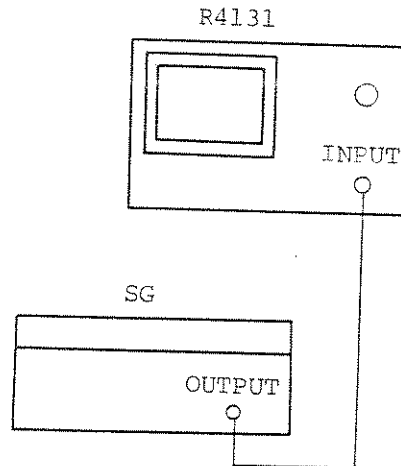

Figure 10-9 Adjustment for Main Span

⑬ Set the SG as follows:

FREQUENCY: 800 MHz
AMPLITUDE: +10 dBm

⑭ Set the R4131 as follows:

CENTER FREQ.: 2 GHz
FREQ. SPAN : 4 GHz

⑮ Adjust the R308 so that the spectrum aligns the scale.

⑯ Set the SG of FM span as follows:

FREQUENCY: 80 MHz
AMPLITUDE: +0 dBm

⑰ Set the R4131 as follows:

FREQ. SPAN: 10 MHz

⑱ Adjust the R319 so that the spectrum aligns the first vertical line from both ends of the scale.

R4131 SERIES
SPECTRUM ANALYZER
INSTRUCTION MANUAL

10.5 YTO-CONT Adjustment (YTO-CONT/IF Board)
(BLR-015116)

- ⑲ Set the SG of 0M tune A as follows:

FREQUENCY: 800 MHz
AMPLITUDE: +0 dBm

- ⑳ R4131 as follows:

CENTER FREQ.: 0 MHz
FREQ. SPAN : 20 MHz
CF CAL

- ㉑ Adjust the R287 so that the local feed-through is 0 MHz \pm 2 MHz.

- ㉒ Set the R4131 as follows:

CENTER FREQ.: 3200 MHz
FREQ. SPAN : 20 MHz
CF CAL

- ㉓ Adjust the R270 so that the spectrum is 3200 MHz \pm 2 MHz.

- ㉔ Repeat steps ⑳ to ㉓.

- ㉕ Tune B

Set the Power switch of the R4131 to OFF.

- ㉖ Set the Power switch to ON while the key is pressed down.

- ㉗ The following data appears on the screen display:

A : 96
B : 32
FM: 32

01,Dec,87

- ㉘ Set the R4131 as follows:

CENTER FREQ.: 0 MHz
FREQ. SPAN : 20 MHz

- ㉙ Turn the encoder so that B: 05 is set.

- ㉚ Press and .

- ㉛ Turn the encoder so that B: CD is set.

- ㉜ Adjust the R269 so that the current waveform aligns the stored waveform.

③③ Tune FM

Set the R4131 as follows:

CENTER FREQ.: 0 MHz
FREQ. SPAN : 200 kHz
SWEEP TIME : 5 ms/

③④ Turn the encoder so that FM: F8 is set.



③⑤ Press ^{STORE} and ^{WRITE}.

③⑥ Turn the encoder so that FM: 32 is set.



③⑦ Adjust the R317 so that the spectrum aligns the stored waveform.

③⑧ Slope

Press ^{SHIFT}, ^{START} ^{PRESET}, and ^{ENTER} and data shown in Figure 2-8 appears.

③⑨ Move the mark "#" to SLOPE_0 V with the  and  keys.

④⑩ Adjust the R261 so that the displayed line aligns with the bottom line on the scale.

④⑪ Similarly, move the mark "#" to SLOPE_2 V/GHz with the  and  keys.

④⑫ Adjust the R257 so that the displayed line aligns with the top line on the scale.

10.6 RF Block Adjustment

10.6.1 Third Local Oscillator Adjustment

- ① Connect the R4136 INPUT to the CAL.OUT connector.
- ② Set the R4136 as follows:
CENTER FREQ.: 200 MHz
FREQ. SPAN : 20 kHz
REF. LEVEL : -25 dBm
RBW : 1 kHz
10 dB/DIV.
- ③ Adjust the C20 so that spectrum positions at the center of the oscillating start frequency and stop frequency.
- ④ Set the R4136 as follows:
1 dB/DIV.
- ⑤ Adjust the R27 so that the CAL.OUT level is -30 dBm \pm 0.5 dB.

10.6.2 Second Local Oscillator Adjustment

- ① Connect 2ND LOCAL OUT on the rear panel of the R4131 to R4136 INPUT.
- ② Set the R4136 as follows:
CENTER FREQ.: 3770 MHz
FREQ. SPAN : 2 MHz
- ③ Turn the adjusting bar on the upper cover of the second local block so that the frequency is 3770 MHz.

10.6.3 Fourth Local Oscillator Adjustment

- ① Remove a shorting pin from the J3 and connect a probe to the J3, pin 2.
- ② Set the R4136 as follows:
CENTER FREQ.: 30 MHz
FREQ. SPAN : 500 kHz
REF. LEVEL : 0 dBm
2 dB/DIV.
- ③ Adjust the L13 so that the peak of the waveform is set.

10.7 Location Diagram of YTO CONT/IF Board

10.7 Location Diagram of YTO CONT/IF Board

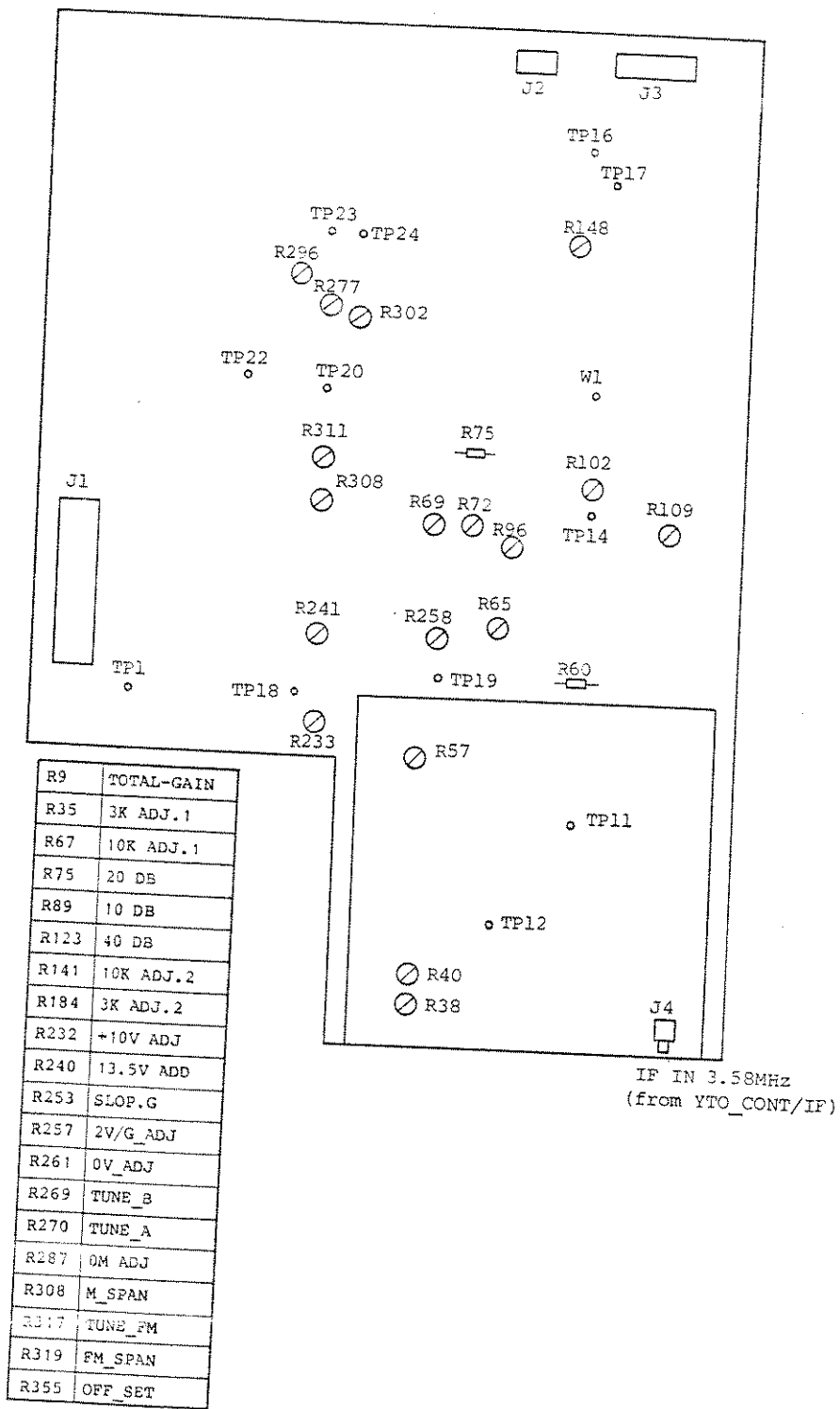

Figure 10-10 Location Diagram of YTO CONT/IF Board

R4131 SERIES
SPECTRUM ANALYZER
INSTRUCTION MANUAL

10.8 Location Diagram of Analog Board

10.8 Location Diagram of Analog Board

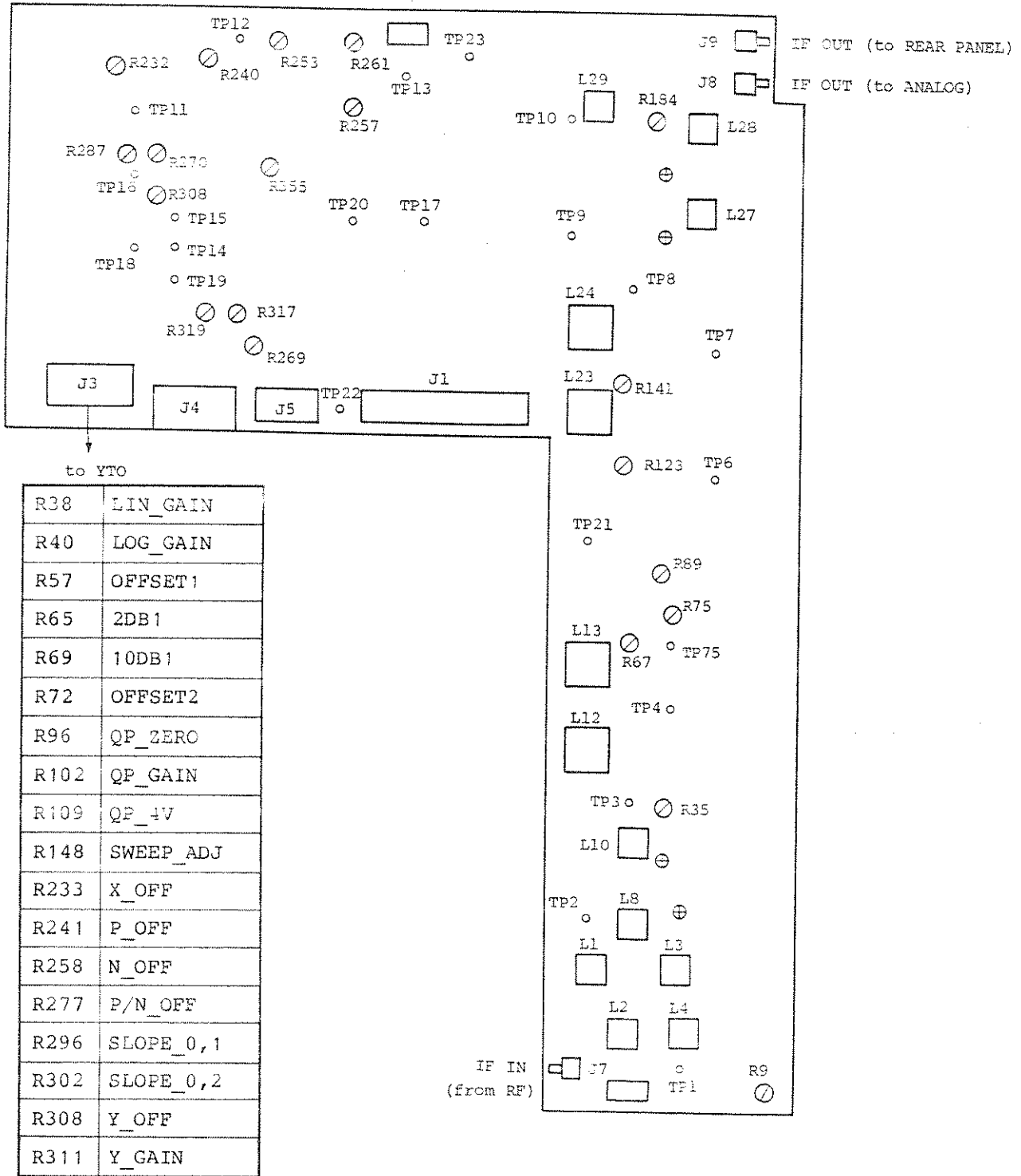



Figure 10-11 Location Diagram of Analog Board

MEMO 

MEMORANDUM FOR THE RECORD

11. PERFORMANCE TESTING

This section describes performance test procedures for the R4131.

11.1 Preparation

The equipment for the performance testing are listed in Tables 11-1.

Table 11-1 Equipment Required for Performance Testing

Equipment	Specifications	Recommended model
(1) Synthesized signal source		TR4511
(2) Function generator	Frequency accuracy: 0.5% or less	
(3) 10 dB step ATT 1 dB step ATT	Accuracy: ± 0.5 dB or less, 0 to 70 dB or more Accuracy: ± 0.1 dB or less, 0 to 12 dB or more	
(4) Power meter	Frequency range: 10 MHz to 8 GHz	
(5) Power sensor		
(6) Sweep oscillator	Frequency range: 10 MHz to 8 GHz	TR4515
(7) Sweep adapter		TR13211
(8) Impedance converter		ZT301

11.2 General Precautions

- (1) Always operate the instrument at the specified voltage. Refer to Section 1.3 for the power line voltage.
- (2) The operating temperature range should be 0°C to 50°C, and the relative humidity less than 85%.
- (3) Warm up the instrument for about 30 minutes before starting the performance test.

11.3 Frequency Span Accuracy

Specification : The frequency span between two arbitrary points on the display screen must be $\pm 5\%$ or less.

Equipment used: Synthesized signal source, function generator

(1) Description

Test the accuracy of frequency span by using the synthesized signal source and function generator.

Use the 800 MHz radio frequency of the synthesized signal for the frequency span of 4 GHz to 1 GHz.

For the frequency span of 500 MHz to 500 kHz, use the reference synthesized signal subtracted by the span width frequency.

For the frequency span of 200 kHz to 50 kHz, use the pulse modulation synthesized signal of the function generator.

(2) Procedure

① Set the R4131 as follows:

FREQUENCY SPAN	: 4 GHz
RESOLUTION BANDWIDTH	: AUTO (1 MHzw)
REFERENCE LEVEL	: COARSE, 10 dB/DIV, -10 dBm
INPUT ATTENUATOR	: 0 dB
TRACE	: WRITE
VIDEO FILTER BAND WIDTH	: 1 MHz
SWEEP TRIGGER	: FREE RUN

② Test frequency spans from 4 GHz to 1 GHz

Referring to Figure 11-1, connect the output of TR4511 synthesized signal source to the INPUT connector of the spectrum analyzer.

③ Set the output of TR4511 synthesized signal source to -5 dBm, 800 MHz, modulation off.

④ Turning the TUNING dial on the spectrum analyzer, adjust the local feedthrough (zero carrier wave) to position it on the leftmost graticule on the display screen. Check that the 4th signal (3.2 GHz) from the local feedthrough (without counting the feedthrough itself) is positioned on or within ± 0.4 division of the eighth graticule from the left most graticule (without counting the leftmost graticule itself). (See Figure 11-1.)

R4131 SERIES
SPECTRUM ANALYZER
INSTRUCTION MANUAL

11.3 Frequency Span Accuracy

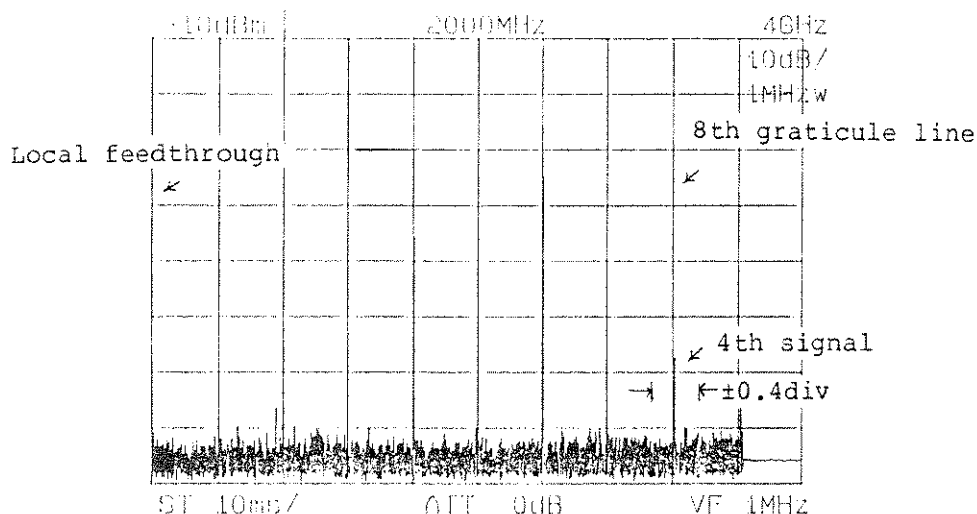

Figure 11-1 Frequency Span 4 GHz Test

- ⑤ With the spectrum analyzer SPAN switch set to 2 GHz, turn the TUNING dial to position the local feedthrough on the leftmost graticule on the display screen. Check that the second signal (1.6 GHz) from the local feedthrough is positioned within ± 0.4 division of the eighth graticule from the left.
- ⑥ Next, with the spectrum analyzer SPAN switch set to 1 GHz, turn the TUNING dial to position the local feedthrough on the leftmost graticule on the display screen. Check that the first signal (800 MHz) from the local feedthrough is positioned within ± 0.4 division of the eighth graticule from the left.

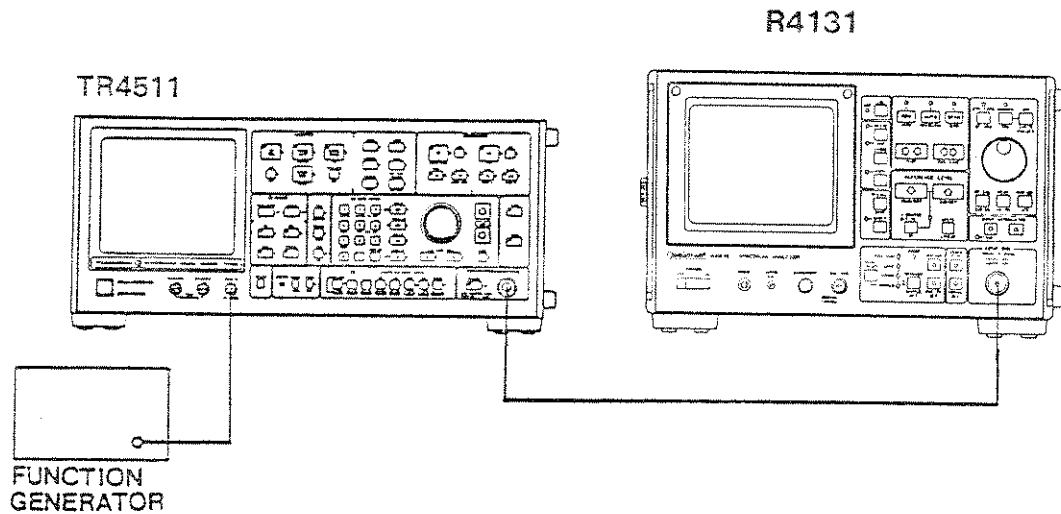

Figure 11-2 Frequency Span Test Setup

- ⑦ Test frequency spans 500 MHz to 500 kHz.
Set the spectrum analyzer INPUT ATTENUATOR switch to 10 dB and the SPAN switch to 500 MHz.
- ⑧ Set the output of TR4511 synthesized signal source to -10 dBm, 1 GHz modulation off.
- ⑨ Turning the TUNING dial, adjust the 1 GHz input signal to the leftmost graticule on the display screen.
- ⑩ Set the output frequency of the TR4511 synthesized signal source to 1.4 GHz. Check that the signal is positioned on the eighth graticule from the leftmost graticule on the display screen (or within ± 0.4 division of the eighth graticule). (See Figure 11-3.)

R4131 SERIES
SPECTRUM ANALYZER
INSTRUCTION MANUAL

11.3 Frequency Span Accuracy

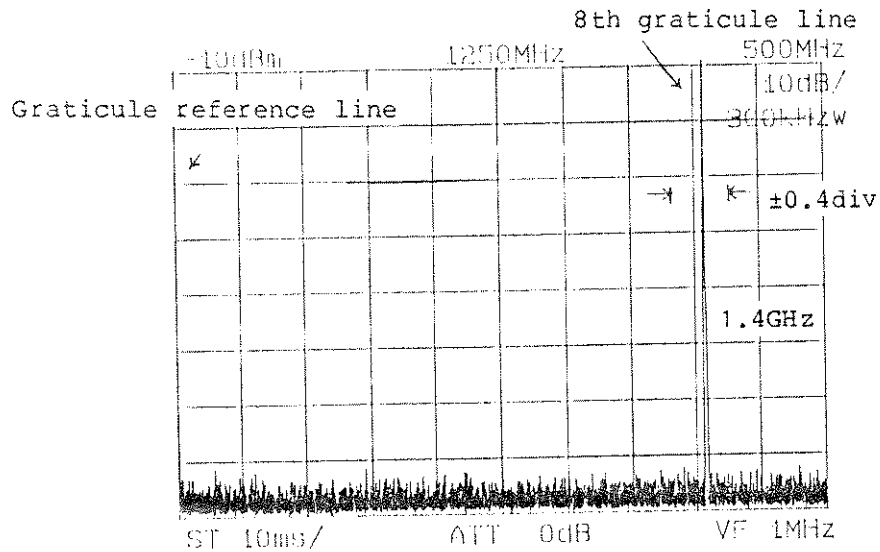

Figure 11-3 Frequency Span 500 MHz Test

- ⑪ Perform similar tests by reducing the frequency span to 200 MHz, 100 MHz, and finally to 500 kHz. For each frequency span, adjust the 1 GHz signal to be on the leftmost graticule on the display screen; then, apply a signal having a frequency equal to $1 \text{ GHz} + 0.8 \times \text{span}$, checking that the input signal is positioned on the eighth graticule from the leftmost graticule on the screen (or within ± 0.4 division of the eighth graticule).

Table 11-2 Frequency Span 500 MHz to 500 kHz Test

Frequency span	Signal adjusted to be on the leftmost graticule on the display screen	Second input signal	Tolerance
500 MHz	1 GHz	1.4 GHz	Check that the second input signal is positioned on the eighth graticule from the leftmost graticule on the display screen (or within ± 0.4 division of the eighth graticule.)
200 MHz	1 GHz	1.16 GHz	
100M	1 GHz	1.08 GHz	
50M	1 GHz	1.04 GHz	
20M	1 GHz	1.016 GHz	
10M	1 GHz	1.008 GHz	
5M	1 GHz	1.004 GHz	
2M	1 GHz	1.0016 GHz	
1M	1 GHz	1.0008 GHz	
500k	1 GHz	1.0004 GHz	

⑫ Next, perform frequency span 200 kHz to 50 kHz tests using the same setup as shown in Figure 11-2.

⑬ Set the output of the TR4511 synthesized signal source as follows:

Frequency: 1 GHz

Modulation: External pulse modulation

Output level: -10 dBm

Set the function generator as follows:

Waveform: Square wave

Output amplitude: 0 to +5 V

- ⑭ Set the output frequency of the function generator to 20 kHz. Turn the TUNING dial to bring the reference spectrum to the leftmost graticule on the display screen. Check that the eighth signal from the reference spectrum is positioned on the eighth graticule from the leftmost graticule on the display screen (or within ± 0.4 division of the eighth graticule). (See Figure 11-4.)

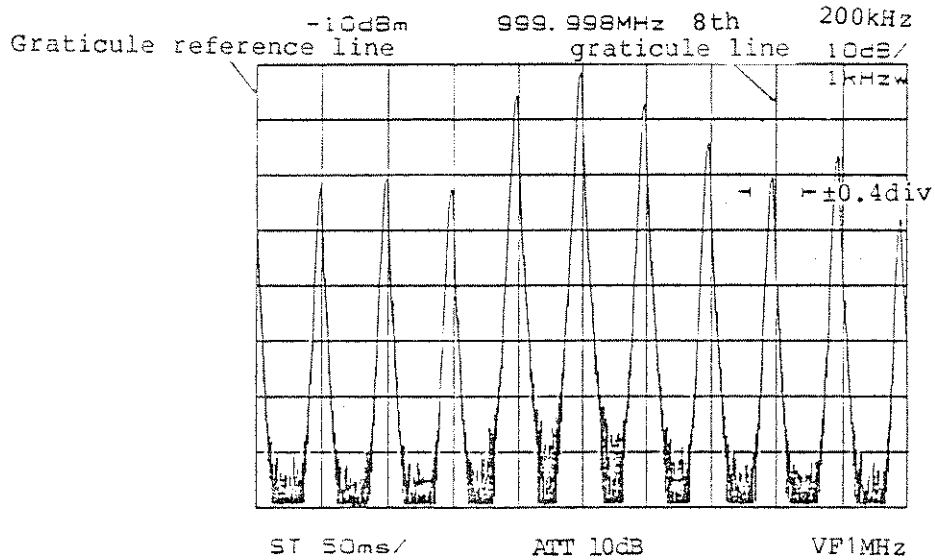

Figure 11-4 Frequency Span 200 kHz Test

- ⑮ Similarly, test frequency span 100 kHz and 50 kHz by referring to Table 11-3.

Table 11-3 Tests for Frequency Spans of 200 kHz or Less

Span	Function generator output frequency	Eighth span position
200 kHz	20 kHz	Within ± 0.4 division of the eighth graticule from the leftmost graticule on the display screen
100 kHz	10 kHz	
50 kHz	5 kHz	

11.4 Center Frequency Readout Accuracy

Specification : R4131C/CN ...
Less than ± 10 MHz
After ZERO CAL
R4131D/DN ...
Less than ± 100 kHz + SPAN 3% or less
after ZERO CAL
Within the range of 0 Hz to 2.5 GHz in center frequency
and 5 ms to 0.5 S/DIV in sweep time.
Less than ± 10 MHz
After ZERO CAL
Center frequency 2.5 GHz or more.

Equipment used: TR4511

(1) Description

Display the signal applied from the TR4511 synthesized signal source to the R4131 in the center of the display screen and test this center frequency as displayed.

NOTE: Perform zero calibration before performing the center frequency readout accuracy test. (See Section 4-3)

(2) Procedure

- ① With the spectrum analyzer INPUT connector open, press the ZERO CAL switch to perform zero calibration.
- ② Set the spectrum analyzer as follows:
FREQUENCY SPAN : 4 GHz
RESOLUTION BANDWIDTH : AUTO (1 MHzw)
REFERENCE LEVEL : COARSE, 10 dB/DIV, 0 dBm
INPUT ATTENUATOR : 10 dB
TRACE : WRITE
VIDEO FILTER BAND WIDTH: 1 MHz
SWEEP TRIGGER : FREE RUN

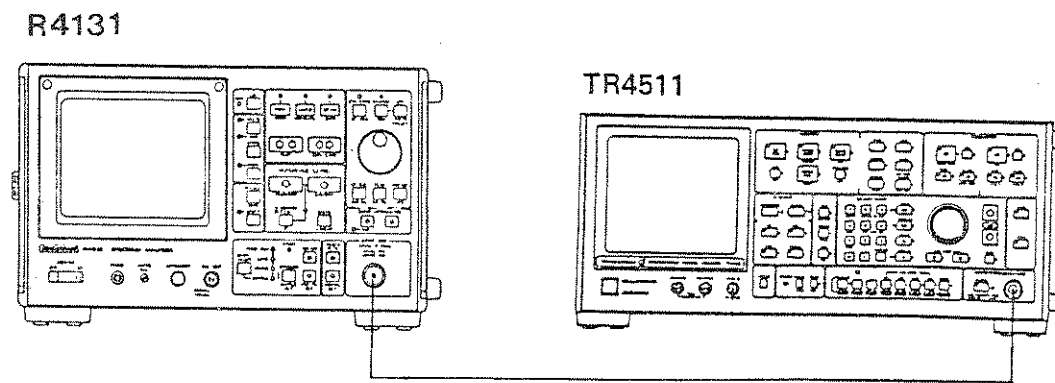

Figure 11-5 Center frequency readout accuracy test setup

R4131 SERIES
SPECTRUM ANALYZER
INSTRUCTION MANUAL

11.4 Center Frequency Readout Accuracy

- ③ Set the frequency to test the TR4511 synthesized signal source. An example of 1 GHz.
- ④ Set the dial of spectrum analyzer to 1000 MHz, gradually decrease the frequency span from 4G, 2G, 1G and so on, and set the frequency span so that the waveforms can be displayed within the screen.
- ⑤ Make sure that the shift from the center frequency is within the range of specifications (see Figure 11-6).

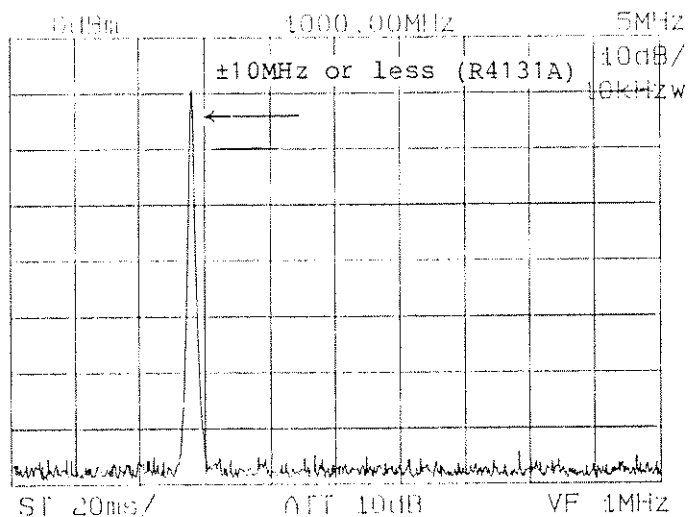

Figure 11-6 Center Frequency Readout Accuracy Test

11.5 Residual FM

Specification: Less than 2 kHz_{p-p}/100 ms

(1) Description:

The calibration signal with a stabilized frequency from this spectrum analyzer is used to perform the residual FM test. The test is performed by FM demodulation by using the R4131 as a fixed tuned receiver with its frequency span set to zero span.

Demodulation is accomplished by using the slope of the spectrum analyzer IF bandpass filter.

NOTE: When performing the residual FM test, install the spectrum analyzer in a place free from vibration, because accuracy of measurement is extremely susceptible to vibrations.

(2) Procedure

- ① Set the spectrum analyzer as follows:
FREQUENCY SPAN : 100 MHz
CENTER FREQ : 200 MHz
RESOLUTION BANDWIDTH : AUTO (300 kHzw)
REFERENCE LEVEL : COARSE, 2 dB/DIV, -40 dBm
INPUT ATTENUATOR : 10 dB
TRACE : WRITE
VIDEO FILTER BAND WIDTH: 1 MHz
SWEEP TRIGGER : FREE RUN
- ② Connect the spectrum analyzer CAL OUT connector and the INPUT connector with the supplied cable as shown in Figure 11-7.

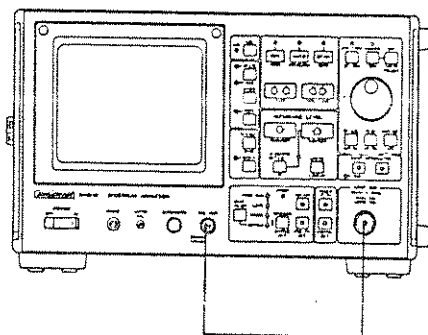

Figure 11-7 Residual FM Test Setup

- ③ Reduce the spectrum analyzer frequency span to 100 kHz. If the 200 MHz signal moves from the center of the display screen, center it again by turning the TUNING dial. The resolution bandwidth is set to 10 kHz.
- ④ Set the spectrum analyzer to the ZERO SPAN mode, and turn the TUNING dial to bring the signal level closer to the center line on the display screen.
- ⑤ With the sweep time/division set to 0.1 second, press the STORE switch twice to keep the waveform still. Check that the peak-to-peak level change in any division (that is, 0.1 second) on the horizontal axis is 1.2 divisions or less as shown in Figure 11-8.

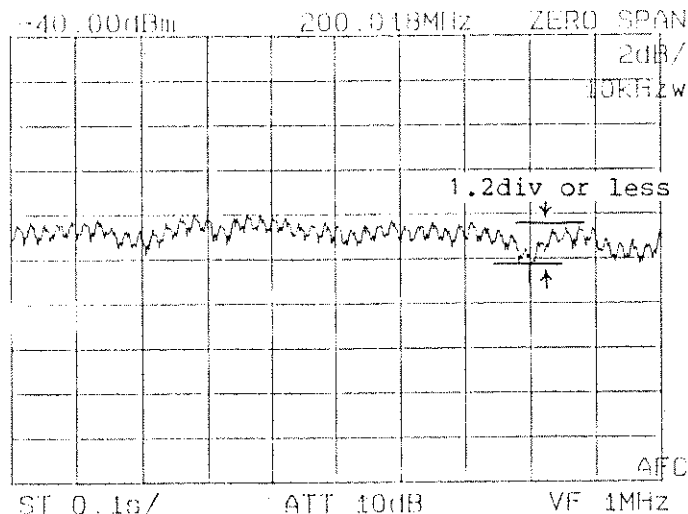

Figure 11-8 Residual FM Test

The value of 1.2 divisions has been acquired for the following reason: The 10 kHz bandwidth filter of the spectrum analyzer is used to allow the residual FM to be displayed on the display screen. The residual FM can be visually observed when the spectrum analyzer is set to a resolution bandwidth of 10 kHz. (See Figure 11-9.) As can be seen from this figure, a 2 kHz change in the frequency axis moves the level about 1.2 divisions.

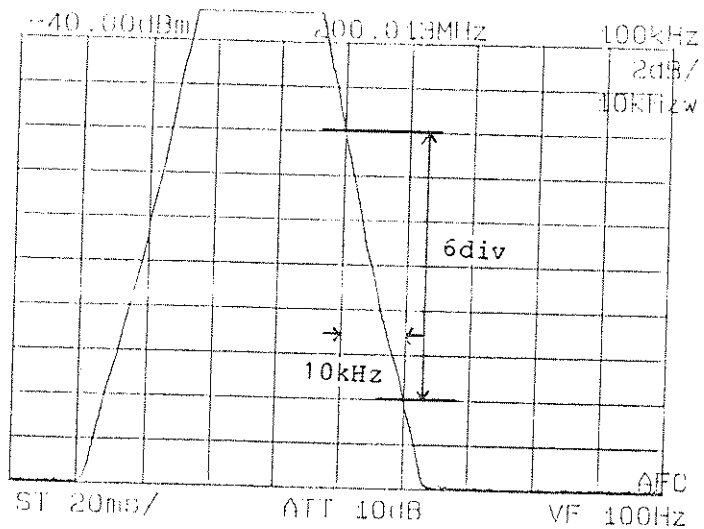

Figure 11-9 Residual FM to AM Conversion Display

Therefore, if the peak-to-peak level change as shown in Figure 11-8 is less than 1.2 divisions, it follows that the residual FM is less than 2 kHz.

11.6 Noise Sidebands

Specification: -80 dBc or less with a resolution bandwidth of 1 kHz and 10 Hz video filter at the position which is 20 kHz from the carrier

Equipment used: Synthesized signal source

(1) Description

The noise sidebands test is performed using stable, high-purity 1 GHz, -10 dBm signals.

(2) Procedure

- ① Connect the spectrum analyzer and the synthesized signal source to each other as shown in Figure 11-10.
- ② Set the output of the synthesized signal source to 1 GHz (carrier wave) and -10 dBm.
- ③ Set the spectrum analyzer as follows:
FREQUENCY SPAN : 1 GHz
CENTER FREQ : 1 GHz
RESOLUTION BANDWIDTH : AUTO (300 kHzw)
REFERENCE LEVEL : COARSE, 10 dB/DIV, -10 dBm
INPUT ATTENUATOR : 10 dB
TRACE : WRITE
VIDEO FILTER BAND WIDTH: 1 MHz
SWEEP TRIGGER : FREE RUN

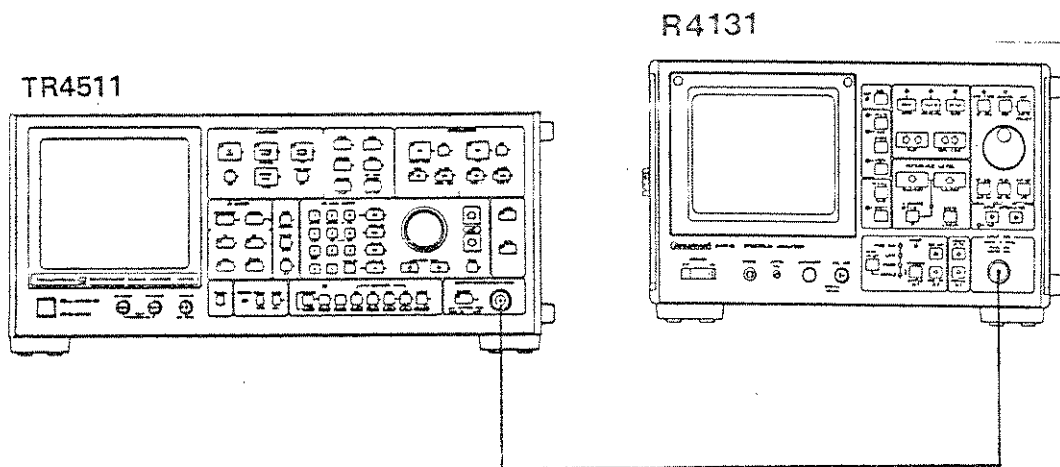

Figure 11-10 Noise Sidebands Test Setup

- ④ Reduce the span to 100 kHz. If the waveform peak moves from the center of the display screen, center it again by turning the TUNING dial.
- ⑤ If the peak moves from the center of the display screen, center it again by turning the TUNING dial.

- ⑥ Set the reference level to -30 dBm and the video filter to 10 Hz.
- ⑦ Measure the noise sidebands at the position which is 2 divisions (20 kHz) from the center of the display screen. Check that the noise sidebands is lower than the reference level by 60 dB or more as shown in Figure 11-11.

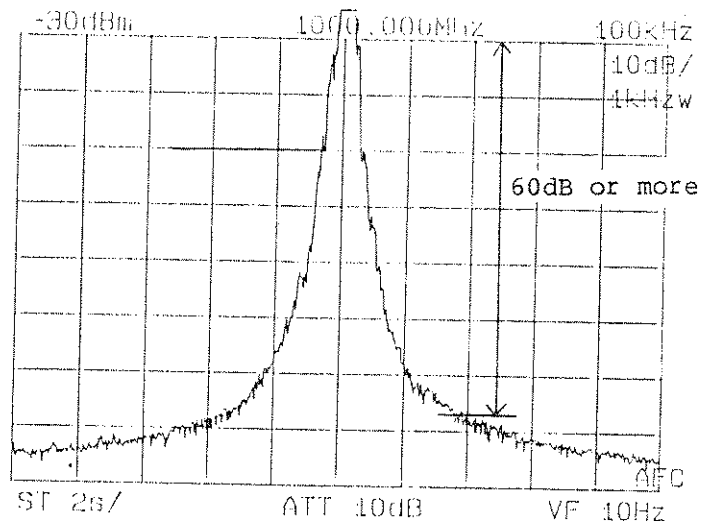

Figure 11-11 Noise Sidebands Measurement

11.7 Resolution Bandwidth Accuracy

Specification: Resolution bandwidth between -3 dB points from the signal peak must be calibrated to $\pm 20\%$ or less.

Equipment used: Synthesized signal source

(1) Description

The resolution bandwidth is tested by setting the spectrum analyzer vertical axis to the 2 dB/division mode and measuring the width between two points -3 dB from the signal peak.

Resolution bandwidths narrower than 3 kHz are tested by applying 3.58 MHz signals to the spectrum analyzer IF FILTER IN connector.

(2) Procedure

- ① Connect the calibration signal of the spectrum analyzer to the INPUT connector as shown in Figure 11-12 (a).

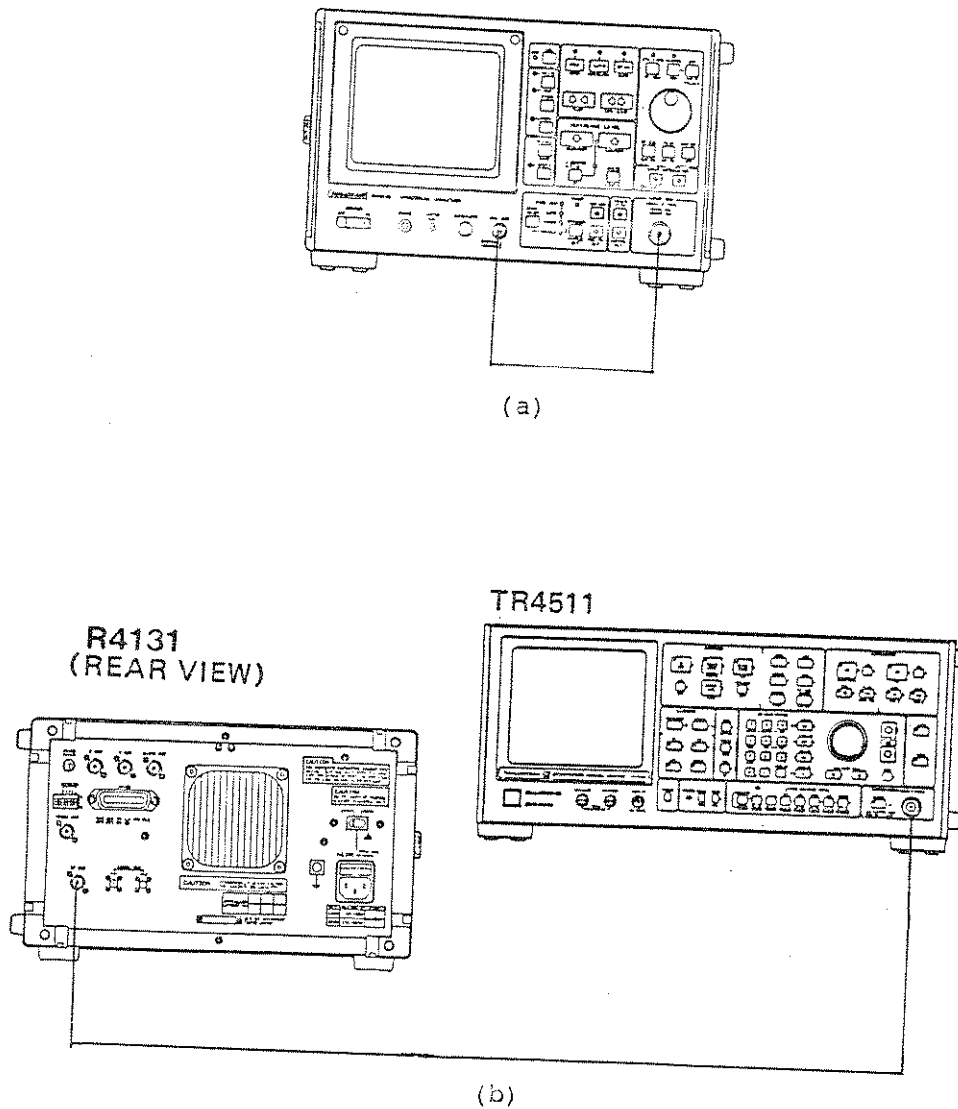

Figure 11-12 Resolution Bandwidth Accuracy Test Setup

② Set the spectrum analyzer as follows:

FREQUENCY SPAN	: 1 GHz
CENTER FREQ	: 200 MHz
RESOLUTION BANDWIDTH	: AUTO
REFERENCE LEVEL	: COARSE, 2 dB/DIV, -23 dBm
INPUT ATTENUATOR	: 10 dB
TRACE	: WRITE
VIDEO FILTER BAND WIDTH:	1 MHz

R4131 SERIES
SPECTRUM ANALYZER
INSTRUCTION MANUAL

11.7 Resolution Bandwidth Accuracy

SWEEP TRIGGER : FREE RUN
SWEEP TIME/DIV: 10 ms

- ③ Set the span to 2 MHz. If the signal peak moves from the center of the display screen, center it again by turning the TUNING dial.
- ④ Set the resolution bandwidth to 1 MHz.
- ⑤ Turning the spectrum analyzer AMPTD CAL control, adjust the signal peak to be 1.5 divisions (3 dB) above the horizontal axis in the center of the display screen. (See Figure 11-13.) Then, measure the width of the two points on the horizontal axis traversed by the signal. This width is taken as the 3 dB bandwidth.

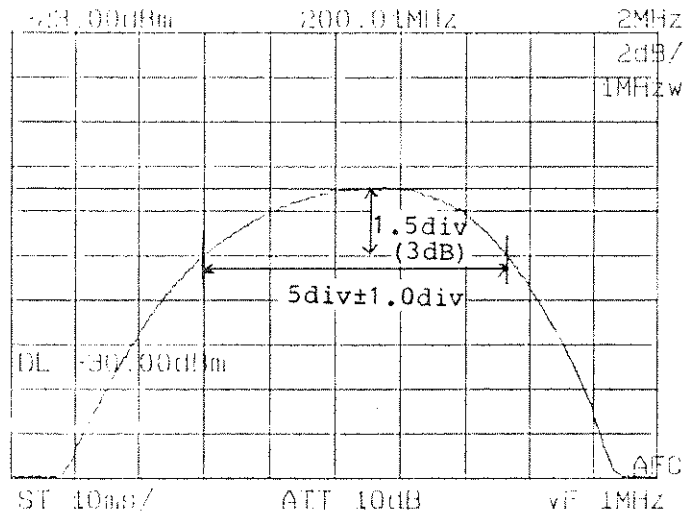

Figure 11-13 Resolution Bandwidth Accuracy Test

- ⑥ Move the signal to left and right by turning the TUNING dial to determine the order of the graduation in which the measured bandwidth falls. Check that this width is between 4 and 6 divisions (5 ± 1 divisions).
- ⑦ Change the spectrum analyzer frequency span and resolution bandwidth to the values specified in Table 11-4, and repeat steps ⑤ and ⑥ above.

Table 11-4 Resolution Bandwidth Test 1 MHz to 10 kHz

Resolution bandwidth	Frequency span	3 dB down width	
		min.	max.
1 MHz	2 MHz	4 div	6 div
300 kHz	500 kHz	4.8 div	7.2 div
100 kHz	200 kHz	4 div	6 div
30 kHz	100 kHz	2.4 div	3.6 div
10 kHz	50 kHz	1.6 div	2.4 div

- ⑧ In testing resolution bandwidths 3 kHz to 1 kHz, remove the top cover of the spectrum analyzer and apply 3.58 MHz, -20 dBm signals to the IF FILTER IN connector from the synthesized signal source. (See Figure 11-12 (b).)
- ⑨ Set the spectrum analyzer resolution bandwidth to 3 kHz and adjust the output frequency of the synthesized signal source for the maximum waveform peak by varying the output frequency at the 10 Hz place.
- ⑩ Adjust the output level of the synthesized signal synthesized source to bring the spectrum analyzer display level to 1.5 divisions above the horizontal axis in the center of the display screen.
- ⑪ Reduce the output frequency of the synthesized signal source until the waveform peak displayed on the display screen coincides with the horizontal axis in the center of the display screen. Record this output frequency as f_1 .
- ⑫ Next, increase the output frequency of the synthesized signal source until the waveform peak rises once above the horizontal axis in the center of the display screen, and then correspondingly falls. Record this output frequency as f_2 .
- ⑬ Determine the 3 dB bandwidth by calculating f_2 minus f_1 . Check that this value falls between 2.4 and 3.6 kHz (3 ± 0.6 kHz or less).
- ⑭ Test resolution bandwidths 1 kHz according to Table 11-5. Keep records of the resultant 3 dB resolution bandwidth values for use in the resolution bandwidth selectivity test described in Section 11.8.

R4131 SERIES
SPECTRUM ANALYZER
INSTRUCTION MANUAL

11.7 Resolution Bandwidth Accuracy

Table 11-5 Resolution Bandwidth Accuracy Test 3 kHz to 1 kHz

Resolution bandwidth	TR4511 output frequency variation place	f2 - f1	
		min.	max.
3 kHz	10 Hz	2.4 kHz	3.6 kHz
1 kHz	10 Hz	0.8 kHz	1.2 kHz

3 Resolution Bandwidth Selectivity

Specification: 60 dB/3 dB resolution bandwidth ratio: 15 : 1
Equipment used: Synthesized signal source

(1) Description

The 60 dB bandwidth of the spectrum analyzer is determined first, and is then compared with the 3 dB bandwidth obtained in Section 11.7 to determine resolution bandwidth selectivity. As in Section 11.7, the resolution bandwidth selectivity is tested in two parts: 1 MHz to 10 kHz, and 3 kHz or less resolution bandwidths.

(2) Procedure:

- 1) Set the spectrum analyzer as follows:

FREQUENCY SPAN	: 4 GHz
CENTER FREQ	: 200 MHz
RESOLUTION BANDWIDTH	: 1 MHzw
REFERENCE LEVEL	: COARSE, 10 dB/DIV, -10 dBm
INPUT ATTENUATOR	: 10 dB
TRACE	: WRITE
VIDEO FILTER BAND WIDTH	: 10 kHz
SWEEP TRIGGER	: FREE RUN
SWEEP TIME/DIV	: 10 ms

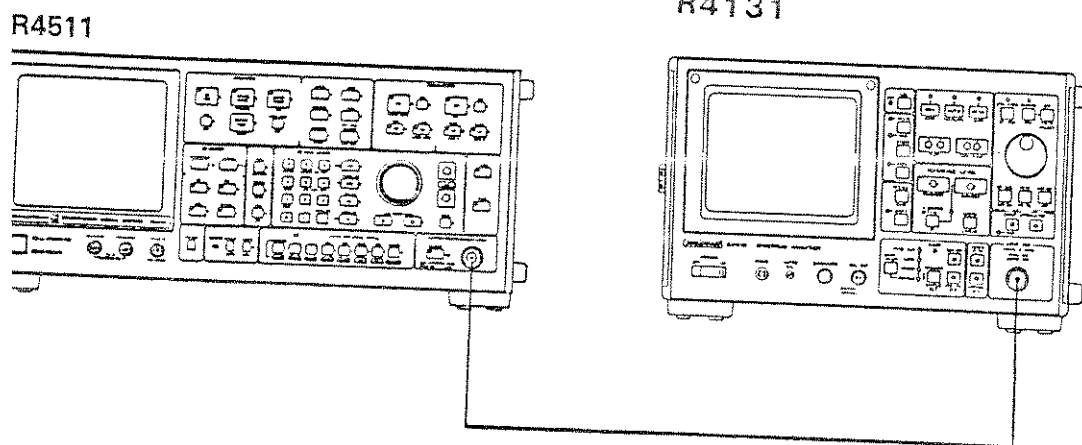

Figure 11-14 Resolution Bandwidth Selectivity Test Setup

Set the synthesized signal source to 200 MHz (CW), -10 dBm. Connect the spectrum analyzer and the synthesized signal source to each other as shown in Figure 11-14.

Press the SPAN switch to activate the frequency span. Reduce the span while turning the TUNING dial to adjust the signal to be in the center of the display screen. Select the minimum span that allows the two points 60 dB lower than the signal peak to be observed on the screen.

R4131 SERIES
SPECTRUM ANALYZER
INSTRUCTION MANUAL

11.8 Resolution Bandwidth Selectivity

- ④ Turn the AMPTD CAL control to bring the signal peak to the top graticule on the display screen.
- ⑤ Turn the TUNING dial to position the 60 dB point for the best reading.
- ⑥ Measure and record the 60 dB bandwidth. Check that the ratio of the 60 dB bandwidth to the 3 dB bandwidth measured in Section 11.7 is 15 or less.
- ⑦ Repeat steps ③ to ⑥ for resolution bandwidths of 300 kHz to 10 kHz as well.
- ⑧ Connect the output of the synthesized signal source to the spectrum analyzer IF FILTER IN connector as shown in Figure 11-12 (b).
- ⑨ Set the output frequency of the synthesized signal source to 3.58 MHz (CW), -20 dBm.
- ⑩ Adjust the output frequency of the synthesized signal source for a maximum reading on the R4131 display screen, and set the signal to be on the reference graticule.
- ⑪ Increase the output frequency of the synthesized signal source until the signal level is reduced 60 dB (6 graticules). Now measure and record this frequency as f1.
- ⑫ Reduce the output frequency of the synthesized signal source until the signal level is up 60 dB (6 graticules). Again, measure and record this frequency as f2.
- ⑬ Determine the 60 dB bandwidth by calculating f1 minus f2. Check that the following relation holds: 60 dB bandwidth/3 dB bandwidth \leq 15.
- ⑭ Repeat steps 10 to 13 for resolution bandwidth of 1 kHz.

11.9 Resolution Bandwidth Switching Accuracy

11.9 Resolution Bandwidth Switching Accuracy

Specification: ± 1 dB (referenced to 300 kHz bandwidth)

(1) Description

The amplitude readout error associated with switching of the resolution bandwidth is measured using a CAL signal.

(2) Procedure

① Set the R4131 as follows:

FREQUENCY SPAN	: 1 GHz
CENTER FREQ	: 200 MHz
RESOLUTION BANDWIDTH	: 1 MHz
REFERENCE LEVEL	: COARSE, 2 dB/DIV, -28 dBm
INPUT ATTENUATOR	: 10 dB
TRACE	: WRITE
VIDEO FILTER	: 10 kHz
SWEEP TRIGGER	: FREE RUN
SWEEP TIME/DIV	: 10 ms

② Connect the CAL input to the INPUT connector. (See Figure 11-15.)

③ Set the span to 2 MHz, while turning the TUNING dial to center the waveform on the display screen.

④ Pressing the RBW switch, set the resolution bandwidth to 300 kHz.

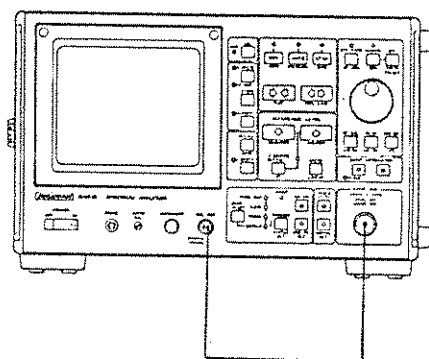

Figure 11-15 Resolution Bandwidth Switching Accuracy Test Setup

⑤ Turn the AMPTD CAL control to adjust the signal peak to be 1 division lower than the reference graticule on the display screen.

R4131 SERIES
SPECTRUM ANALYZER
INSTRUCTION MANUAL

11.9 Resolution Bandwidth Switching Accuracy

- ⑥ Set the resolution bandwidth to 1 MHz. Check that the maximum amplitude point is ± 1 dB (± 0.5 division) or less when compared to the 300 kHz resolution bandwidth.
- ⑦ Similarly, set the span and the resolution bandwidth to 100 kHz. Check that the maximum amplitude point is ± 1 dB or less when compared to the 300 kHz resolution bandwidth.
- ⑧ Also test resolution bandwidths 30 kHz to 1 kHz at the settings specified in Table 11-6.

Table 11-6 Bandwidth Switching Uncertainty

Resolution bandwidth	Frequency span/division	Amplitude readout change
1 MHz	2 MHz	± 1 dB
300 kHz	2 MHz	0 dB (REF.)
100 kHz	1 MHz	± 1 dB
30 kHz	200 kHz	± 1 dB
10 kHz	100 kHz	± 1 dB
3 kHz	50 kHz	± 1 dB
1 kHz	50 kHz	± 1 dB

11.10 LOG Linearity and LIN Linearity

Specification: LOG linearity: ± 1 dB/10 dB, ± 0.15 dB/1 dB, ± 1.5 dB/70 dB
LIN linearity: $\pm 5\%$ of full scale
Equipment used: Synthesized signal source
10 dB step ATT
1 dB step ATT

(1) Description

Linearity test is performed by utilizing the marker on the display screen when the aid of the external signal and the attenuators.

(2) Procedure

LOG linearity

① Set the R4131 as follows:

FREQUENCY SPAN : 1 GHz
CENTER FREQ : 200 MHz
RESOLUTION BANDWIDTH : AUTO
REFERENCE LEVEL : -10 dB
INPUT ATTENUATOR : 10 dB
TRACE : WRITE
VIDEO FILTER BAND WIDTH: 1 MHz
SWEEP TRIGGER : FREE RUN

② Set the output frequency of the synthesized signal source to 200 MHz (CW), -10 dBm, and connect the synthesized signal source to the spectrum analyzer INPUT connector using attenuators as shown in Figure 11-16.

R4131 SERIES
SPECTRUM ANALYZER
INSTRUCTION MANUAL

11.10 LOG Linearity and LIN Linearity

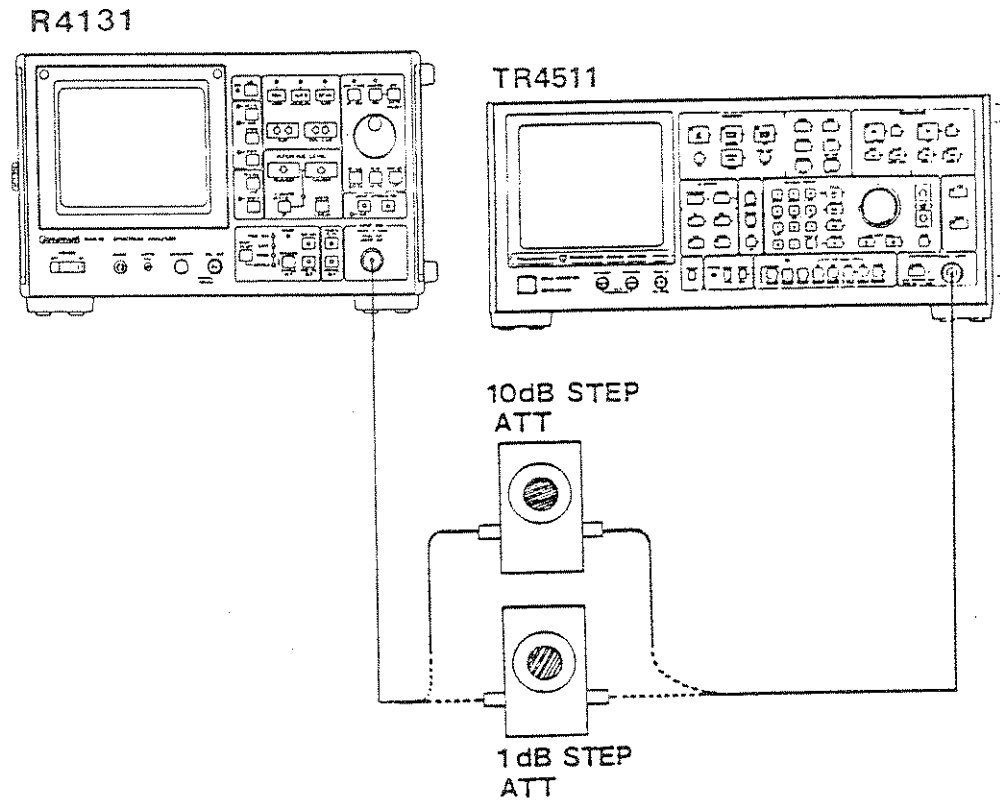

Figure 11-16 LOG/LIN Linearity Test Setup

- ③ Set the 10 dB step ATT to 0 dB.
- ④ Set the span to 2 MHz while turning the TUNING dial to position the signal peak in the center of the display screen. Then, make the following settings:
Resolution bandwidth : 30 kHz
Sweep time/division : 20 ms
Video filter band width: 10 kHz
- ⑤ Press the MARKER switch and turn the TUNING dial to position the marker at the signal peak.
- ⑥ Adjust the AMPTD CAL control to set the marker level reading to -10.0 dBm.
- ⑦ Vary the 10 dB step ATT 10 dB at a time, checking that the marker level values conform to the values of Table 11-7. With an attenuator setting of 70 dB, set the video filter to 100 Hz and the sweep time/division to 0.1 s in order to prevent noise being superimposed on the signal.

NOTE: If the marker moves off the signal peak during measurement, position it at the signal peak again by turning the TUNING dial.

Table 11-7 LOG Linearity

ATT setting	Marker level readout	Video filter	Sweep time/div
0	-10 dBm (REF)	10 kHz	20 ms
10	-20 ±1 dBm	10 kHz	20 ms
20	-30 ±1 dBm	10 kHz	20 ms
30	-40 ±1 dBm	10 kHz	20 ms
40	-50 ±1 dBm	10 kHz	20 ms
50	-60 ±1 dBm	10 kHz	20 ms
60	-70 ±1 dBm	10 kHz	20 ms
70	-80 ±1.5 dBm	100 Hz	0.1 s

- ⑧ Connect the 1 dB step ATT to the spectrum analyzer and set the video filter to 10 kHz and the sweep time/division to 20 ms.
- ⑨ Set the ATT to 0 dB.
- ⑩ Set the R4131 reference level to 2 dB/division and the resolution bandwidth to 300 kHz. Turn the AMPTD CAL control to adjust the marker level to be -10.0 dBm.
- ⑪ Set the ATT to 2 dB. Check that the resultant marker level reading is -12 dBm ±0.3 dB, or less.
Next, set the ATT to 10 dB. Check that the resultant marker level reading is -20 dBm ±1 dB, or less.

LIN linearity

- ⑫ Set the ATT to 0 dB, and set the output level of the synthesized signal source to -10 dBm (70.71 mV).
- ⑬ Set the R4131 to the LIN mode, and position the marker at the signal peak. Turn the AMPTD CAL control until the marker level is set to 70.71 mV (on the reference graticule).
- ⑭ Set the ATT to 6 dB. Check that the marker level reading is 35.4 mV ±3.5 mV, or less.

11.11 Reference Level Accuracy

Specification: The reference level as varied with MIN INPUT ATT 10 dB (fixed) must be accurate to within 1 dB.

Equipment used: Synthesized signal source
10 dB step ATT
1 dB step ATT

(1) Description

The reference level accuracy can be determined by testing the IF GAIN accuracy in the LOG display mode.

(2) Procedure

① Set the R4131 as follows:

FREQUENCY SPAN : 1 GHz
CENTER FREQ : 200 MHz
RESOLUTION BANDWIDTH : AUTO
REFERENCE LEVEL : FINE, 2 dB/DIV, 0 dBm
INPUT ATTENUATOR : 10 dB
TRACE : WRITE
VIDEO FILTER BAND WIDTH: 1 MHz
SWEEP TRIGGER : FREE RUN

② Set the output frequency of the synthesized signal source to 200 MHz (CW), -10 dBm, and connect the source to the spectrum analyzer INPUT connector using attenuators as shown in Figure 11-17.

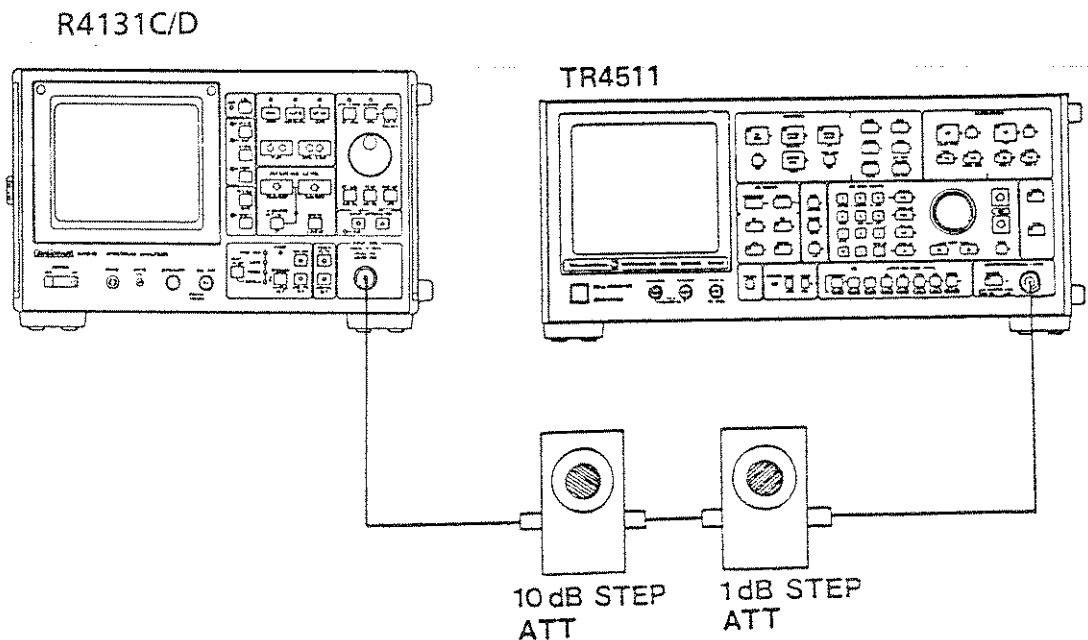

Figure 11-17 Reference Level Accuracy Test Setup

- ③ Set both the 10 dB and 1 dB step ATTs to 0 dB.
- ④ Set the span to 2 MHz while turning the TUNING dial to position the signal peak in the center of the display screen.
- ⑤ Then, make the following settings:
Resolution bandwidth: 300 kHz
Video filter : 1 kHz
Sweep time/division : 50 ms
- ⑥ Press the MARKER switch and turn the TUNING dial to position the marker at the signal peak.
- ⑦ Adjust the AMPD CAL control to set the marker level reading to -10.0 dBm.
- ⑧ With the 1 dB step ATT at 1 dB, set the reference level to -1.00 dBm. Check that the marker level reading is -11.00 ±1 dB or less.
- ⑨ Proceed with further testing with the settings specified in Table 11-8.

Table 11-8 Reference Level Accuracy

Reference level setting	ATT setting	Marker readout level
0 dBm	0 dB	-10.00 dBm (REF.)
-1 dBm	1 dB	-11.00 ±1 dBm
-2 dBm	2 dB	-12.00 ±1 dBm
-3 dBm	3 dB	-13.00 ±1 dBm
-4 dBm	4 dB	-14.00 ±1 dBm
-5 dBm	5 dB	-15.00 ±1 dBm
-6 dBm	6 dB	-16.00 ±1 dBm
-7 dBm	7 dB	-17.00 ±1 dBm
-8 dBm	8 dB	-18.00 ±1 dBm
-9 dBm	9 dB	-19.00 ±1 dBm
-10 dBm	10 dB	-20.00 ±1 dBm
-20 dBm	20 dB	-30.00 ±1 dBm
-30 dBm	30 dB	-40.00 ±1 dBm
-40 dBm	40 dB	-50.00 ±1 dBm
-50 dBm	50 dB	-60.00 ±1 dBm

11.12 Residual Responses

Specification:

R4131C/D ...
-95 dBm or less (at an input attenuator setting of 0 dB)
R4131CN/DN ...
-93 dBm or less (at an input attenuator setting of 0 dB)

(1) Description

Residual responses refers to the signal displayed on the display screen in the absence of input. Testing is performed at 100 MHz intervals in the range 100 kHz to 3.5 GHz.

(2) Procedure

- ① After terminating the spectrum analyzer INPUT connector with a 50 Ω terminator (R4131C/D) and a 75 Ω terminator (R4131CN/DN), set the spectrum analyzer as follows:

FREQUENCY SPAN	: 100 MHz
CENTER FREQ	: 50 MHz
RESOLUTION BANDWIDTH	: 30 kHz
REFERENCE LEVEL	: COARSE, 10 dB/DIV, -50 dBm
INPUT ATTENUATOR	: 0 dB
TRACE	: WRITE
VIDEO FILTER BAND WIDTH:	1 kHz
SWEEP TRIGGER	: FREE RUN
SWEEP TIME/DIV	: 1 s
- ② Set the TRIGGER MODE switch to SINGLE and press the START switch to test residual responses in the range of 0 to 100 MHz. Check that the residual responses is -95 dBm or less (R4131C/D), -93 dBm or less (R4131CN/DN).
- ③ Turn the TUNING dial to set the center frequency to 150 MHz. Press the START switch to test residual responses in the range of 100 to 200 MHz. Check that the residual responses is -95 dBm or less (R4131C/D), -93 dBm or less (R4131CN/DN).
- ④ Similarly, test residual responses up to 3.5 GHz at 100 MHz intervals.

11.13 Gain Compression

Specification: *MIX input end must be 1 dBm or less for a -10 dBm input.
[*: (Input signal level) - (MIN INPUT ATT)]

Equipment used: Synthesized signal source
Power meter
Power sensor
10 dB step ATT

(1) Description

The gain compression is tested by checking to see if the reading level rises 10 dB when the MIX input end level is increased from -20 dBm to -10 dBm.

(2) Procedure

- ① Set the R4131 as follows:
FREQUENCY SPAN : 100 MHz
CENTER FREQ : 200 MHz
RESOLUTION BANDWIDTH : AUTO
REFERENCE LEVEL : COARSE, 10 dB/DIV, -10 dBm
INPUT ATTENUATOR : 10 dB
TRACE : WRITE
VIDEO FILTER BAND WIDTH: 1 MHz
SWEEP TRIGGER : FREE RUN
- ② Set the output frequency of the synthesized signal source to 200 MHz (CW) and connect it to the power meter, adjusting the synthesized signal source for 0 dBm output.
- ③ Set the 10 dB step ATT to 10 dB and connect it to the spectrum analyzer as shown in Figure 11-18.

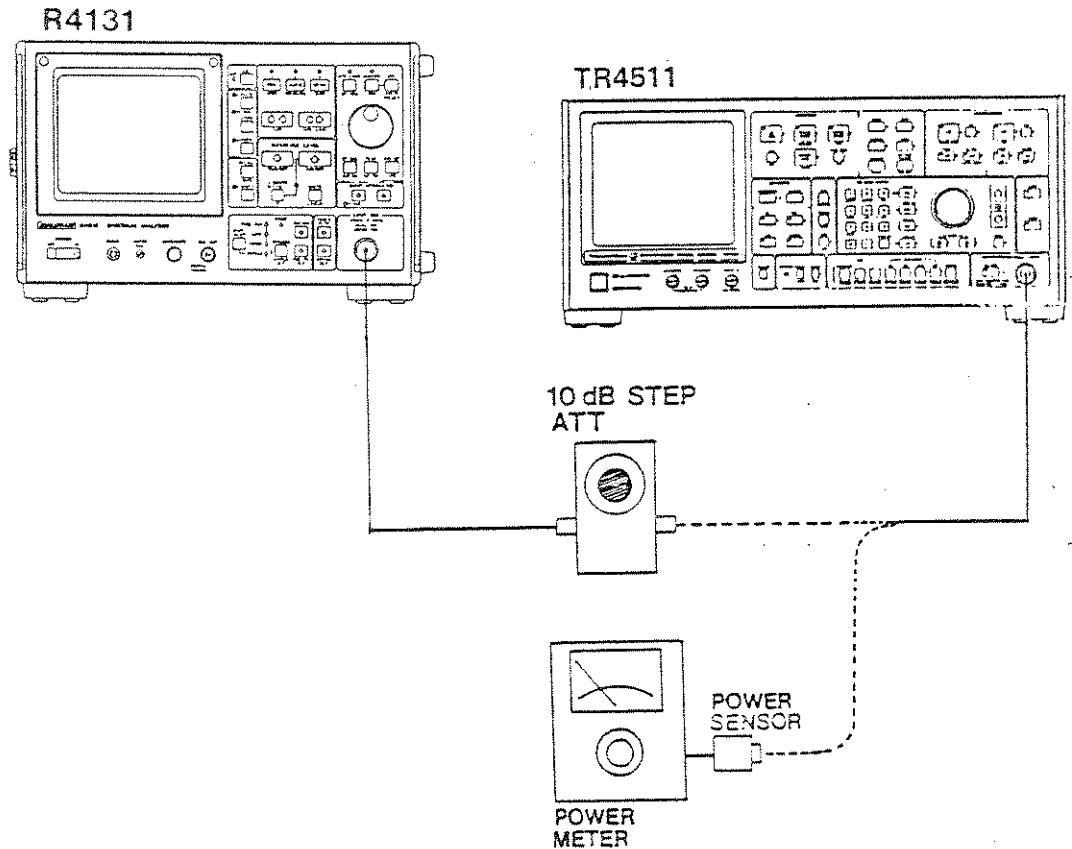

Figure 11-18 Gain Compression Test Setup

- ④ Set the span to 1 MHz while turning the TUNING dial to position the 200 MHz signal in the center of the display screen. Pressing the RBW switch, set the resolution bandwidth to 300 kHz, and set the reference level to 2 dB/DIV.
- ⑤ Turn the AMPTD CAL control to bring the signal peak to the reference graticule (top graticule) on the display screen.
- ⑥ Set both the reference level and the 10 dB step ATT to 0 dB. Check that the signal peak falls within 0.5 division (1 dB) of the top graticule (reference graticule) on the display screen.

11.14 Frequency Response

Specification: Frequency response (MIN INPUT ATT: 10 dB)

R4131C	100 kHz \leq F \leq 2 GHz \pm 1 dB or less		10 kHz \leq F \leq 3.5 GHz \pm 3.5 dB or less
R4131D	100 kHz \leq F \leq 2 GHz \pm 1 dB or less		10 kHz \leq F \leq 3.5 GHz \pm 2 dB or less
R4131CN/DN	100 kHz \leq F \leq 1.5 GHz \pm 1.5 dB or less	10 kHz \leq F \leq 2 GHz \pm 2.5 dB or less	2 GHz \leq F \leq 3.5 GHz \pm 4 dB or less

Equipment used: Sweep oscillator
Power meter
Power sensor
Sweep adapter

(1) Description

Testing is performed by setting the R4131 to the full span mode and a sweep oscillator to the external sweep mode and observing changes of the amplitude reading on the display screen. Since sweep oscillator frequency responses are included in the measurement results, measure the sweep oscillator response with a power meter prior to testing for later correction of the measurements.

(2) Procedure

- ① Set the R4131 as follows:
 - FREQUENCY SPAN : 4 GHz
 - CENTER FREQ : 2000 MHz
 - RESOLUTION BANDWIDTH : AUTO
 - REFERENCE LEVEL : COARSE, 10 dB/DIV, 0 dBm
 - INPUT ATTENUATOR : 10 dB
 - TRACE : WRITE, POSI PEAK
 - VIDEO FILTER BAND WIDTH: 1 MHz
 - SWEEP TRIGGER : FREE RUN
 - SWEEP TIME/DIV : 10 ms
- ② Set the sweep oscillator output to 200 MHz (CW), -10 dBm and connect it to the power meter using the A01002 cable. Adjust the output level of the sweep oscillator to -10 dBm. (See Figure 11-19.)

R4131 SERIES
SPECTRUM ANALYZER
INSTRUCTION MANUAL

11.14 Frequency Response

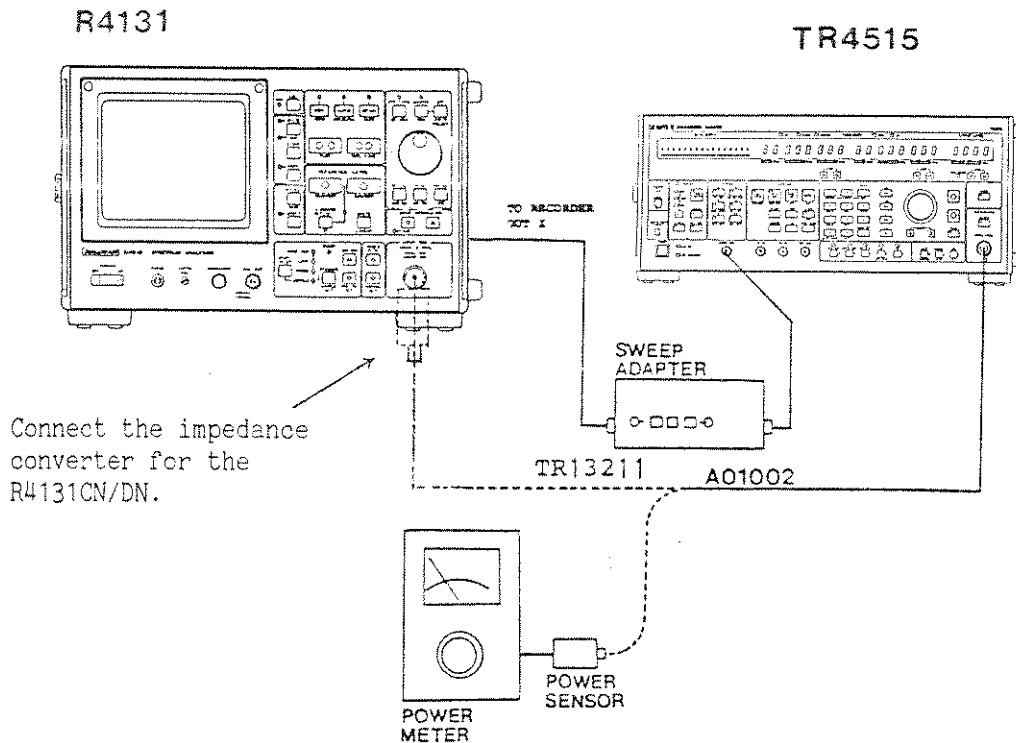

Figure 11-19 Frequency Response Test Setup

- ③ Connect the sweep OSC output to the spectrum analyzer INPUT connector. Connect the impedance converter for the R4131CN/DN. (See Figure 11-19) With its amplitude set to 2 dB/division, set the reference level to display a 200 MHz signal on the center axis of the display screen.
- ④ Set the sweep oscillator to the external sweep mode, and set the start and stop frequencies to 10 MHz and 4 GHz, respectively.
- ⑤ Press the sweep adapter START switch, and adjust the START dial to display the signal at the leftmost position on the display screen. Next, press the STOP switch and adjust the STOP dial to display the signal at the rightmost position on the display screen.
- ⑥ When the SWEEP switch is pressed after the STOP dial has been adjusted, the waveform, shown in Figure 8.20 (a) appears. When a uniform spectrum waveform is not displayed, finely adjust the START and STOP dials.
- ⑦ Set the sweep time/division to 1 s, and the frequency characteristics will be displayed on the display screen. (See Figure 11-20 (b).) Make sure that the ripple current is within the range of the specifications.

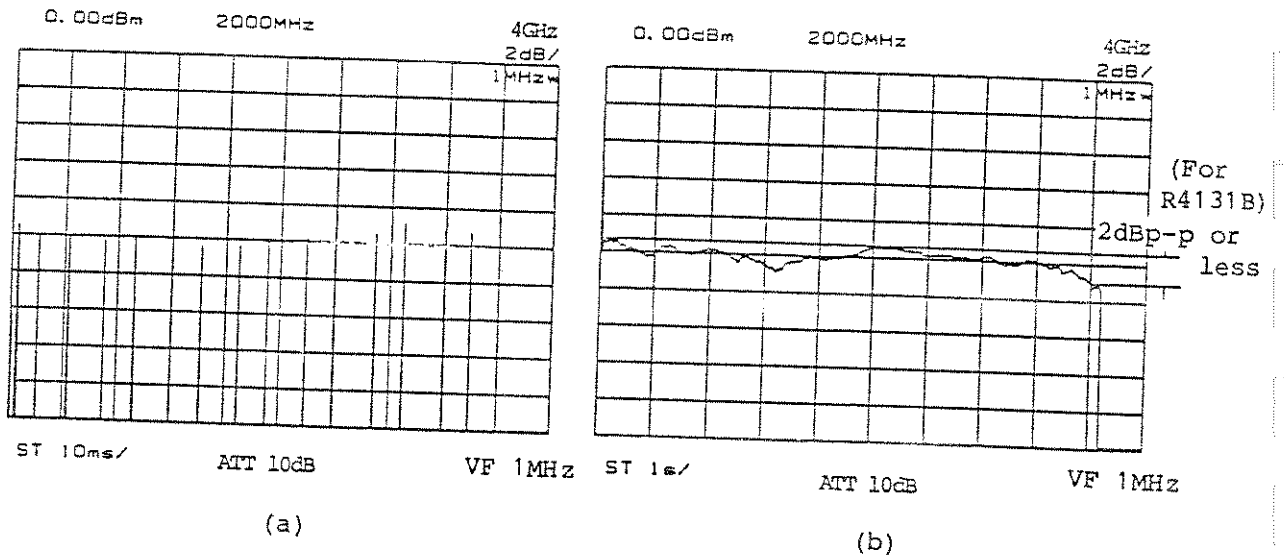

Figure 11-20 Frequency Response (100 kHz - 3.6 GHz)

11.15 Average Noise Level

Specification:

R4131C/D ... -110 dBm or less
R4131CN/DN ... -108 dBm or less
(Resolution bend width 1 kHz, Video filter 10 Hz, Input ATT 0 dB, More than 1 MHz in frequency.)

(1) Description

The average noise level is the maximum value of the average noise levels in the 1 kHz resolution bandwidth with an input ATT setting of 0 dB.

Note: Be sure to perform amplitude calibration (see Section 4.7) before performing this test.

(2) Procedure

① Set the R4131 as follows:

FREQUENCY SPAN : 4 GHz
CENTER FREQ : 2000 MHz
RESOLUTION BANDWIDTH : 1 MHz
INPUT ATTENUATOT : 0 dB
REFERENCE LEVEL : -50 dBm
TRACE : WRITE
VIDEO FILTER BAND WIDTH: 1 kHz
SWEEP TRIGGER : FREE RUN
SWEEP TIME/DIV : 1 s
MARKER : ON

② Turning the TUNING dial, position the marker at the maximum noise level point. (See Figure 11-21)

- ③ Press the MKR→CF switch. (Set the center frequency to the marker frequency.) Set the frequency span to zero span and set the resolution bandwidth to 1 kHz.

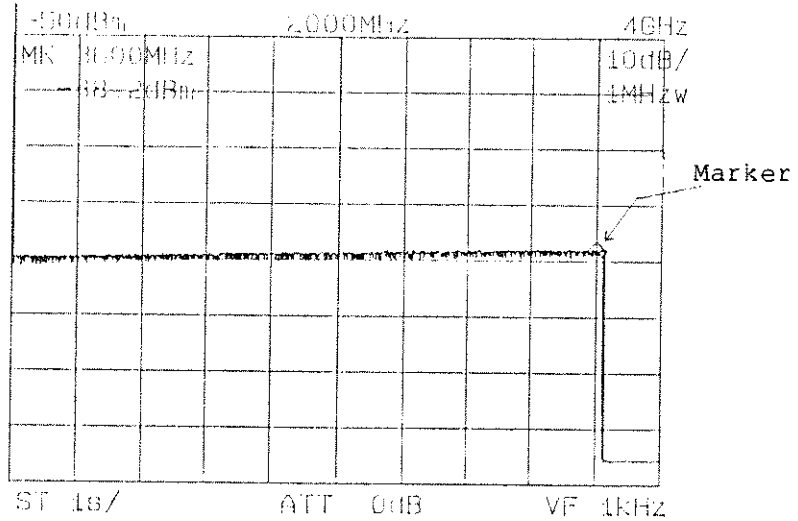

Figure 11-21 Maximum Noise

- ④ Set the video filter to 10 Hz. (See Figure 11-22) Check that the marker level reading is -110 dBm or less (R4131C/D), and -108 dBm or less (R4131CN/DN).

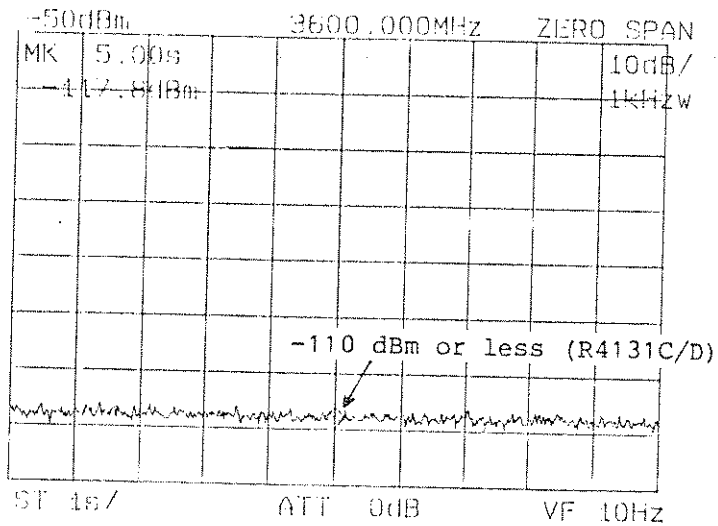

Figure 11-22 Average Noise Level Test

11.16 Sweep Time Accuracy

Specification : $\pm 15\%$
Equipment used: Synthesized signal source
Function generator

(1) Description

Sweep time accuracy is tested by demodulating signals in the R4131 zero span mode after they are amplitude modulated by the function generator and measuring the periods of the demodulated waves.

(2) Procedure

- ① Set the R4131 as follows:

FREQUENCY SPAN	: 100 MHz
CENTER FREQ	: 50 MHz
RESOLUTION BANDWIDTH	: 1 MHz
REFERENCE LEVEL	: 2 dB/DIV, -10 dBm
INPUT ATTENUATOR	: 10 dB
TRACE	: WRITE
VIDEO FILTER BAND WIDTH	: 10 kHz
SWEEP TRIGGER	: FREE RUN
SWEEP TIME/DIV	: 10 ms
- ② Set the output frequency of the synthesized signal source to 50 MHz, -10 dBm, EXT AM mode.
- ③ Set the function generator to generate sine waves at 200 Hz $\pm 0.5\%$.
- ④ Connect the instruments as shown in Figure 11-23. Turn the R4131 TUNING dial to position the signal in the center of the display screen. Further, set the frequency span to zero span and adjust the TUNING dial to obtain the maximum signal level.
- ⑤ Adjust the function generator output level to obtain demodulated waves in the order of 3 DIV_{p-p}.
- ⑥ Adjust the reference level to position the signal at an easily viewed position on the display screen.
- ⑦ Set the TRIGGER MODE switch to VIDEO.
- ⑧ Set the sweep time/division to 5 ms and store the resultant waveform. Check that five periods of the demodulated waves have a duration of 25 ± 3.75 ms, or less. (See Figure 11-24)
- ⑨ Similarly, test other sweep time/division with the settings specified in Table 8-11.

Table 11-9 Sweep Time Accuracy

Sweep time/div	Function generator frequency	Duration of five periods
5 ms	200 Hz $\pm 0.5\%$	25 ms ± 3.75 ms
10 ms	100 Hz $\pm 0.5\%$	50 ms ± 7.5 ms
20 ms	50 Hz	100 ms ± 15 ms
50 ms	20 Hz	250 ms ± 37.5 ms
0.1 s	10 Hz	0.5 s ± 75 ms
0.2 s	5 Hz	1 s ± 150 ms
0.5 s	2 Hz	2.5 s ± 375 ms
1 s	1 Hz	5 s ± 0.75 s
2 s	0.5 Hz	10 s ± 1.5 s
5 s	0.2 Hz	25 s ± 3.75 s
10 s	0.1 Hz	50 s ± 7.5 s

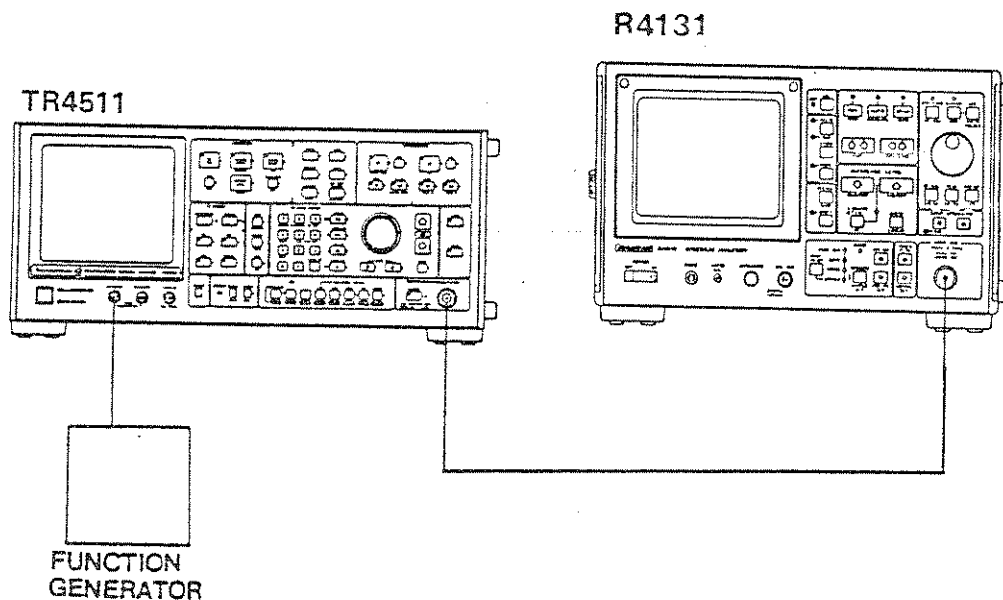

Figure 11-23 Sweep Time Accuracy Test Setup

R4131 SERIES
SPECTRUM ANALYZER
INSTRUCTION MANUAL

11.16 Sweep Time Accuracy

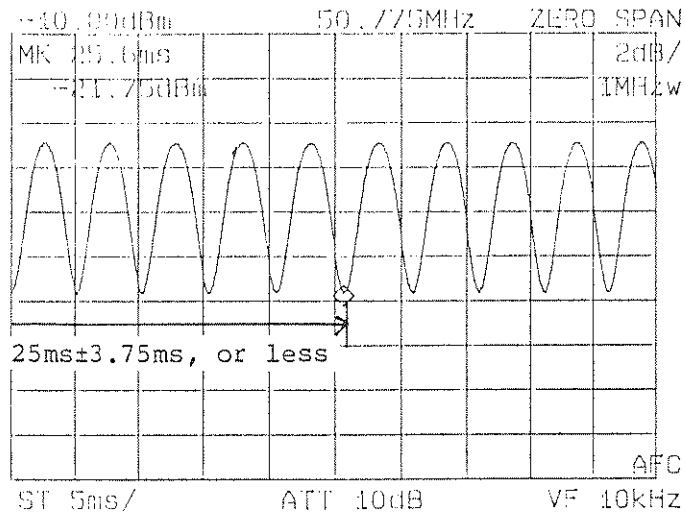

Figure 11-24 Sweep Time Accuracy Test

11.17 Calibrated Output Accuracy

Specification : 200 MHz \pm 30 kHz, -30 dBm \pm 0.5 dB:R4131C/D
200 MHz \pm 30 kHz, 80 dBu \pm 0.5 dB :R4131CN/DN

Equipment used: Synthesized signal source
Power meter

(1) Description

Test the accuracy of CAL signal frequency by using the synthesized signal source. Test the accuracy of signal level by connecting the power meter directly to the CAL signal line.

(2) Procedure

Frequency Test

- ① Press the R4131 ZERO CAL switch.
- ② Set the synthesized signal source to 200 MHz, -30 dBm.
- ③ Connect the synthesized signal source to the spectrum analyzer INPUT connector. Set the span to 100 kHz while turning the TUNING dial to position the 200 MHz signal in the center of the display screen.
- ④ Next, connect the CAL signal to INPUT connector. (See Figure 11-25) Check that the center frequency is 200 MHz \pm 30 kHz, or less.

Amplitude Test

- ① Directly connect the power meter to the CAL OUT signal line.
- ② Make sure that the CAL OUT output signal level is -30 dBm \pm 0.5 dB (R4131C/D) or -28.93 dBm \pm 0.5 dB (R4131CN/DN).

The reason why the R4131CN/DN has the -28.93 dBm signals when the 80 dBu CAL OUT signal is measured on the 50 Ω power meter:

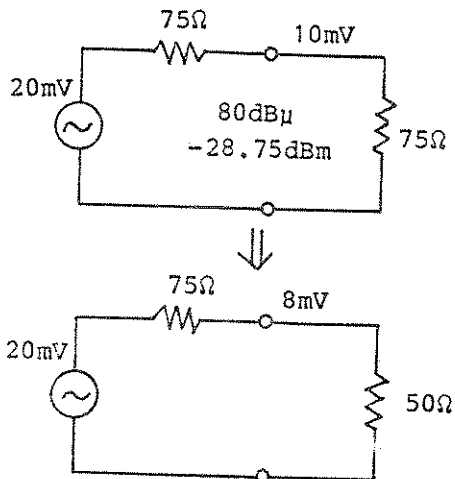

80 dBu, -28.75 dBm is:

$$10 \log P = -28.75 \text{ dBm}$$

$$\frac{V^2}{R} = 1.334 \times 10^{-3} \text{ (mW)}$$

As R = 75 Ω :

$$V = 10.00 \text{ (mV)}$$

Therefore, if the 50 Ω power meter is connected:

$$P = \frac{V^2}{R} = \frac{(8\text{mV})^2}{50} = 1.28 \times 10^{-3} \text{ (mW)}$$

$$10 \log P = \underline{\underline{28.93\text{dBm}}}$$

R4131 SERIES
SPECTRUM ANALYZER
INSTRUCTION MANUAL

11.17 Calibrated Output Accuracy

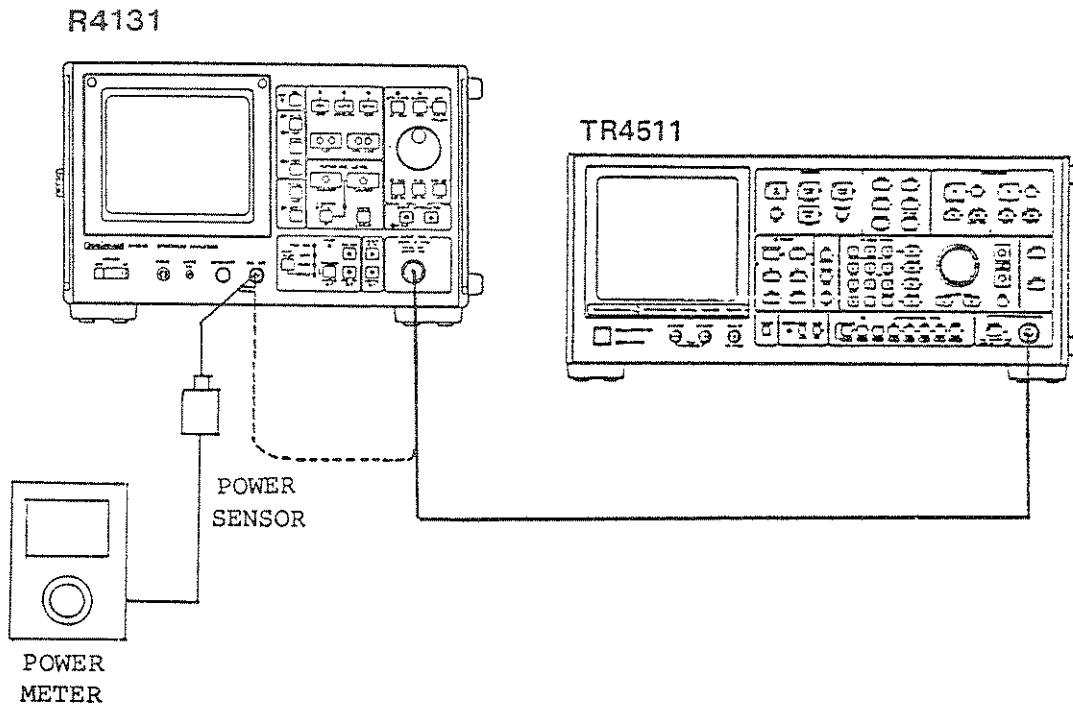

Figure 11-25 Calibrated Output Accuracy Test Setup

MEMO



R4131 SERIES
SPECTRUM ANALYZER
INSTRUCTION MANUAL

12. Maintenance Data

12. MAINTENANCE DATA

12.1 Preparation

The equipment and tools necessary for troubleshooting are listed in Table 12-1. The equipment must have equivalent or better performance ratings than those in the table.

Table 12-1 Equipment and Tools Required For

Equipment	Performance	Recommended equipment
Digital voltmeter	Range : ± 1000 V Accuracy : $\pm 0.1\%$ Input impedance: $10\text{ M}\Omega$	TR6846
High frequency power meter	Frequency : 100 kHz to 8 GHz Sensitivity: -30 dBm to +20 dBm Accuracy : ± 0.5 dB	
DC power supply	Output voltage: ± 10 V Accuracy : $\pm 0.03\%$	TR6142
Oscilloscope	Frequency range: DC to 100 MHz Input impedance: $1\text{ M}\Omega$	
Signal generator	Frequency range : 100 kHz to 1800 MHz Output level : ± 10 dBm or more Output impedance : $50\ \Omega$ Frequency accuracy: $2\text{ E-}8/\text{day}$ Variable frequency: 1 Hz step	TR4512
FET probe	Frequency range: DC to 500 MHz Input impedance: $1\text{ M}\Omega$ or more, 2 pF or less	
Spectrum analyzer	Frequency range : 10 MHz to 8 GHz Frequency accuracy: ± 100 kHz	R4136
Spectrum analyzer	Input frequency range : 100 kHz to 1.8 GHz Tracking generator output: 400 kHz to 1.8 GHz T.G. output flatness : ± 1 dB Impedance : $50\ \Omega$	TR4171 or R4136 + TR4154
High frequency power meter	Frequency : 100 kHz to 1500 MHz Sensitivity: -30 dBm to +20 dBm Accuracy : ± 0.5 dB	

R4131 SERIES
SPECTRUM ANALYZER
INSTRUCTION MANUAL

12.1 Preparation

Table 12-2 Maintenance Tools Required for Troubleshooting

Product name	Stock number	Remarks
Cable (UM-UM)	MM-17	
Cable (SMA-SMA)	MM-14	
Cable (BNC-BNC)	MI-02	
Cable (BNC-UM)	MC-36	2 pcs.
UM to UM Linear Adapter	JCF-AC001JX07	
SMA to SMA Adapter	JCF-AA001JX28	

12.2 Location Diagram (Top & Bottom)

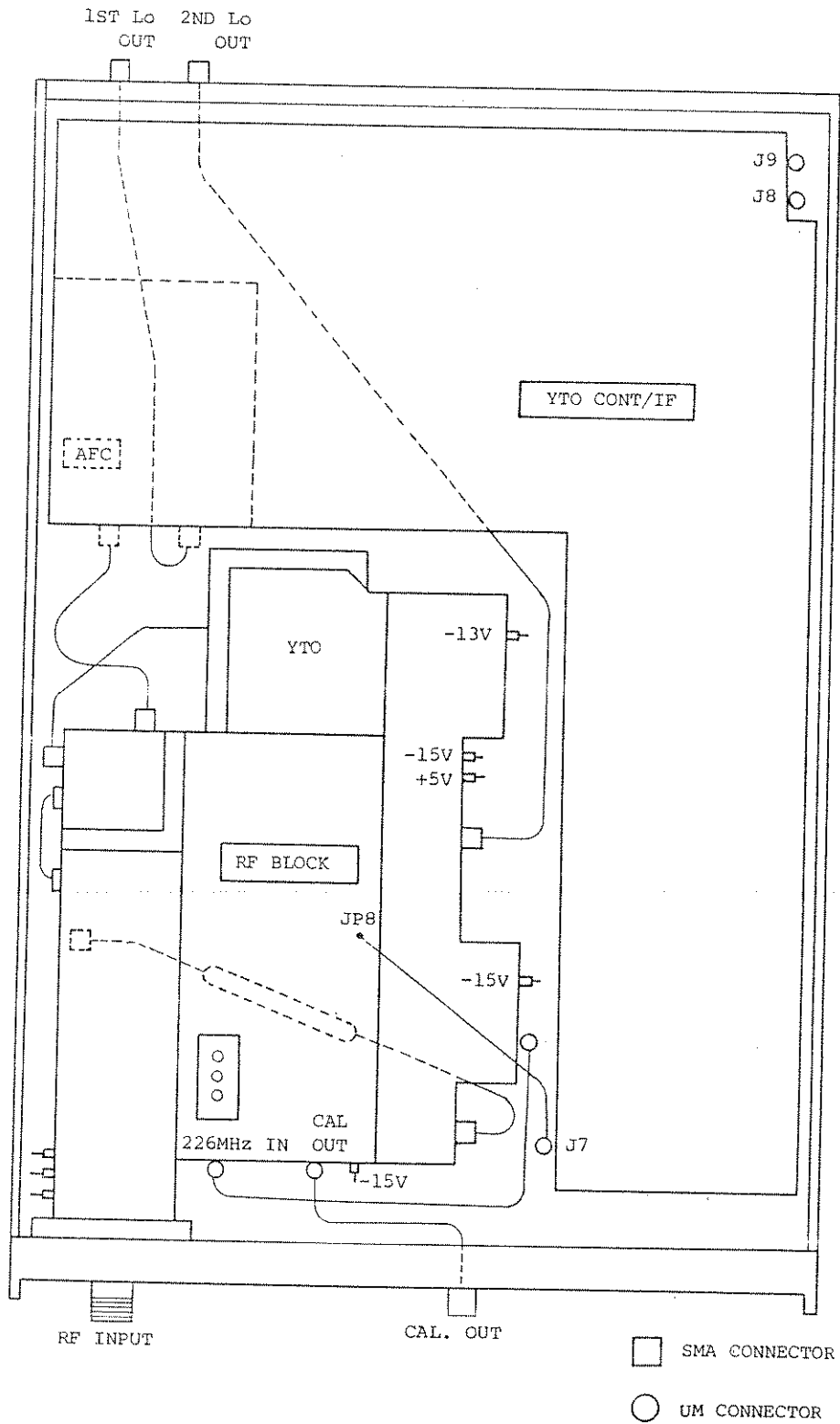
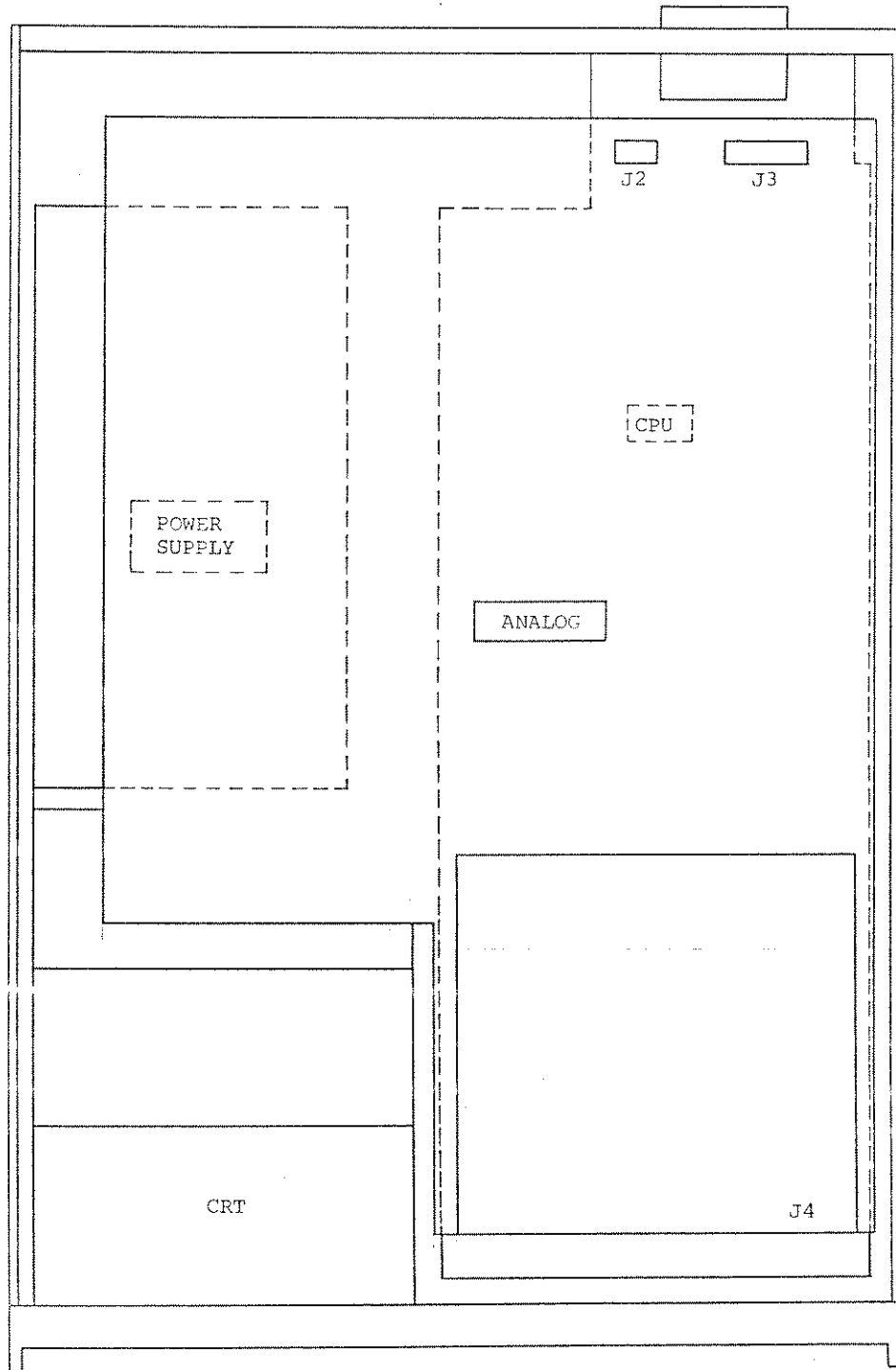

Figure 12-1 Location Diagram (Bottom View)

R4131 SERIES
SPECTRUM ANALYZER
INSTRUCTION MANUAL

12.2 Location Diagram (Top & Bottom)



- SMA CONNECTOR
- UM CONNECTOR

Figure 12-2 Location Diagram (Top View)

12.3 Location Diagram for RF

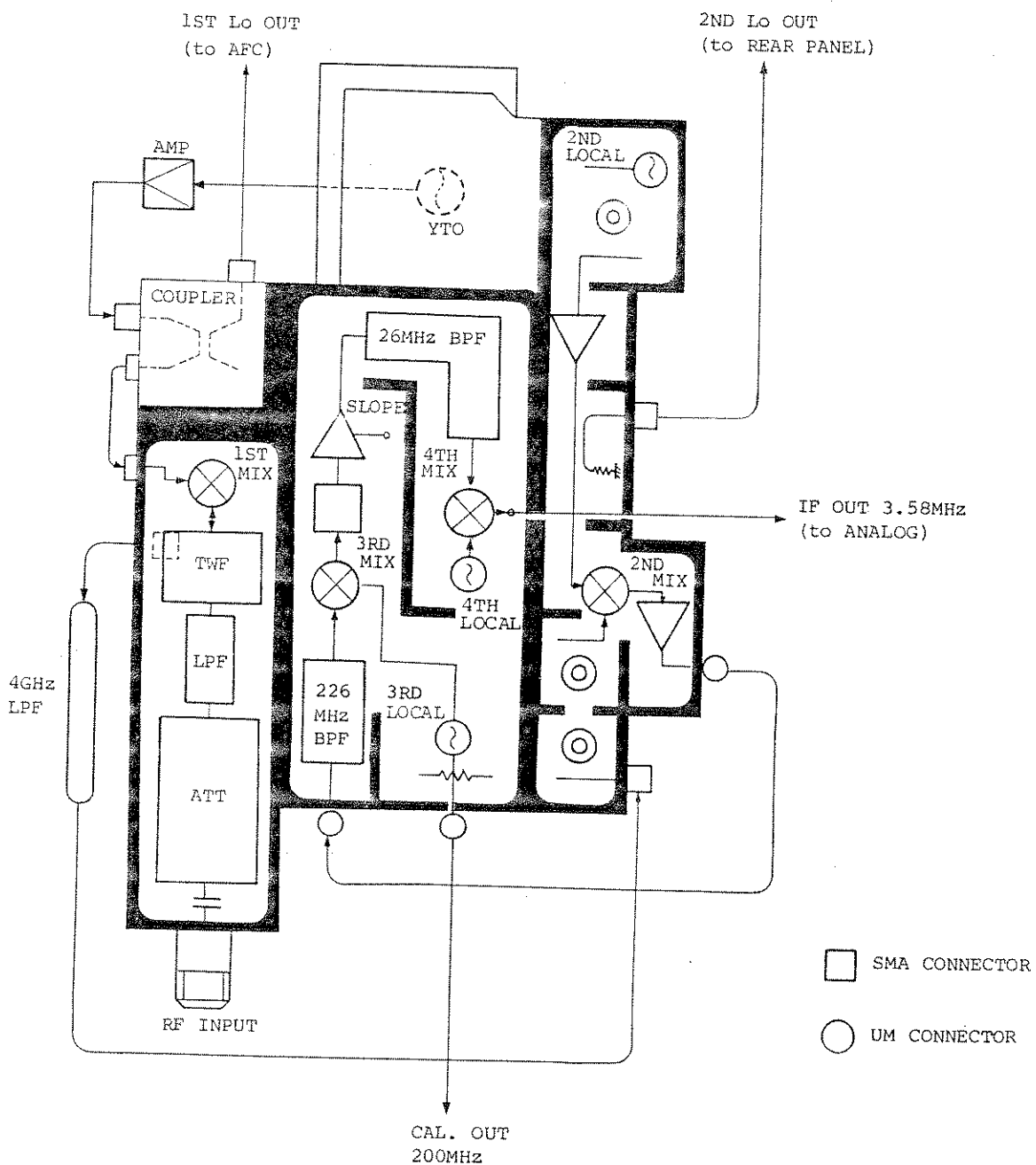

Figure 12-3 Location Diagram for RF

R4131 SERIES
SPECTRUM ANALYZER
INSTRUCTION MANUAL

12.4 Block Diagram

12.4 Block Diagram

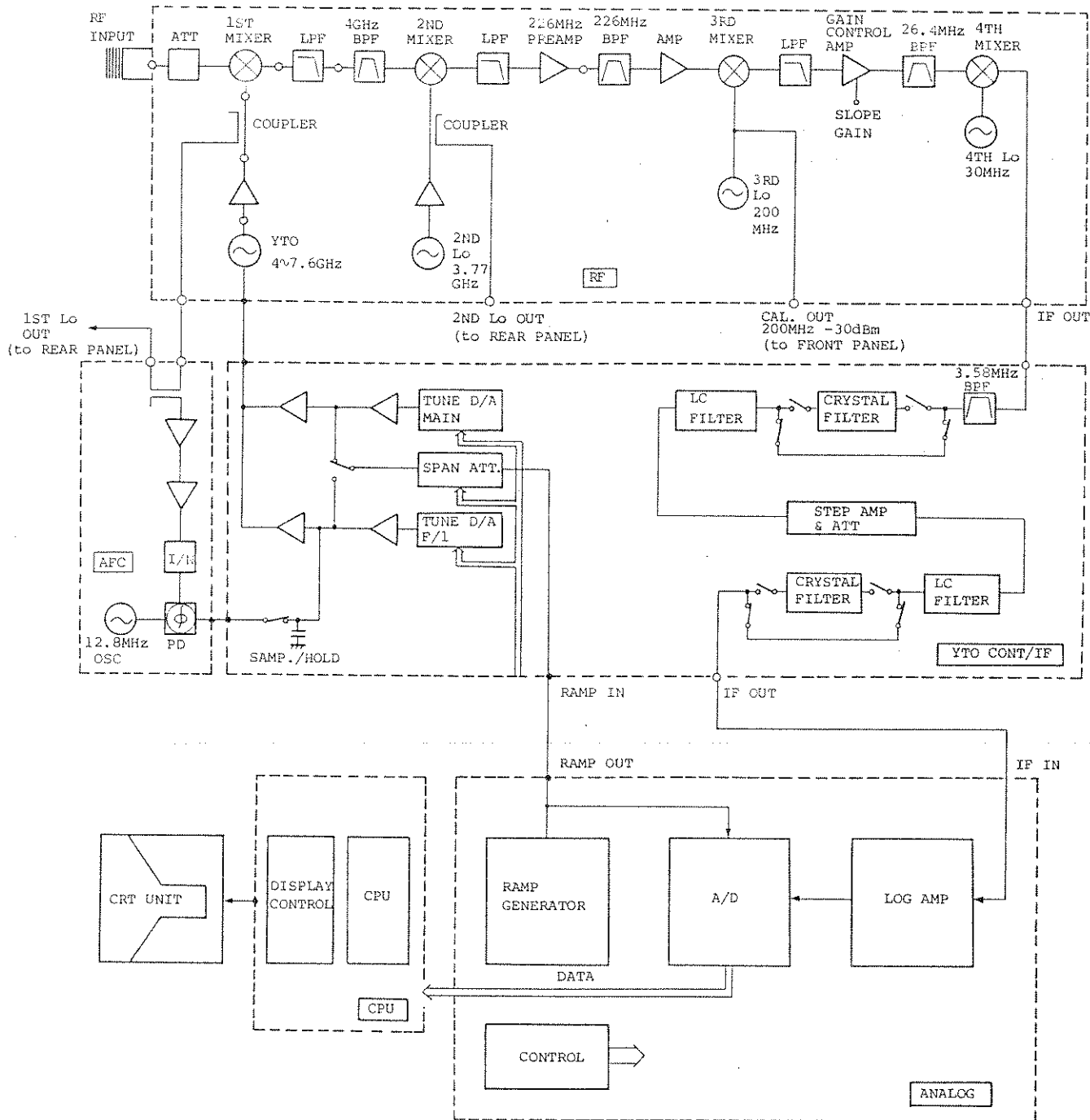

Figure 12-4 Block Diagram

12.5 Self Test

The R4131 performs SELF TEST for the RAM and ROM on the CPU board when power is turned on.

In the case there is a failure RAM or ROM, the following error message is displayed on the CRT.

Message	Mean
RAM error	Failure RAM U26 or U32 (SMM-8464C-5) on the CPU board (BLR-015114)
ROM error	Failure ROM U21 (SMM-27C25-1) on the CPU board (BLR-015114)

R4131 SERIES
SPECTRUM ANALYZER
INSTRUCTION MANUAL

Appendix

APPENDIX



A.1 Explanation of Terminologies

IF Bandwidth

In this spectrum analyzer, a band pass filter (BPF) is used to analyze each frequency component included in input signals. The 3 dB bandwidth of this BPF is called the IF band (see Figure A-1 (a)). The BPF characteristic should be set to the appropriate size according to the sweep width and sweep speed. In this equipment, it is set to the maximum value according to the sweep width. Since this bandwidth can generally improve the resolution (a degree of separation) more and more when it is set narrower, the resolution of the spectrum analyzer is expressed in the narrowest IF bandwidth in some cases (see Figure A-1 (b)).

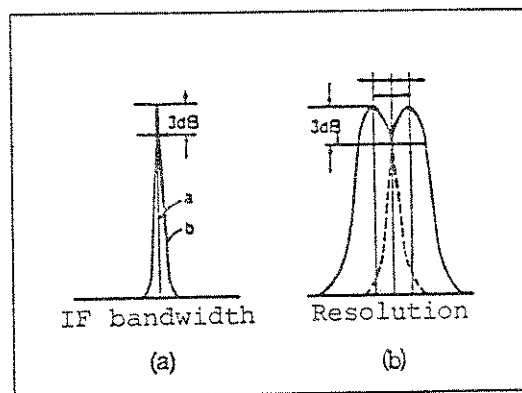

Figure A-1 IF Bandwidth

Gain Compression

In case the input signal becomes larger than a certain value, no correct value is displayed on the CRT screen and a somewhat compressed phenomenon occurs even when the input signal is increased. This is called the gain compression. It expresses the linearity of the input signal range. In general, a level range is used until 1 dB is compressed.

Input Sensitivity

This means the highest capacity of a spectrum analyzer to detect minor signals. The sensitivity is related to the noise generated from the spectrum analyzer itself and it depends on the IF bandwidth used. Generally, the input sensitivity expresses the average noise level in the minimum IF bandwidth of that spectrum analyzer.

Maximum Input Level

This is the maximum allowable level of the input circuit of a spectrum analyzer. The allowable level can be changed by the input attenuator.

Residual FM

This is a method to express a short term frequency stability of the local oscillator groups integrated in a spectrum analyzer. The frequency straying per unit time is expressed in p-p. This also indicates the critical value when the residual FM of a measured signal is measured.

Residual Responses

This defines to what level value the spurious signal generated in a spectrum analyzer is suppressed when calculated in terms of the input level. This signal is caused when a particular signal, e.g., the local oscillator output, etc., inside the spectrum analyzer is leaked. Care should be taken in this respect when a very small input signal is analyzed.

Quasi Peak Value Measurements

Disturbing noise received in radio communication often appears in an impulsive state. As an objective evaluation of this disturbance, the disturbing noise component is evaluated with a value proportional to its peak value. Such prerequisite factors as the measuring bandwidth and detection time constant for this measurement are used as the quasi peak values. This is represented by the JRTC Standards in Japan and by the CISPR Standards internationally.

Frequency Response

Frequency response is usually used as a term to indicate the amplitude characteristic with frequency (frequency characteristic). In spectrum analyzer, this term means the frequency characteristic (flatness) of an input attenuator, mixer, etc. at each input frequency. It is represented by \pm dB.

Frequency Span

This means the display range of the ordinates axis (frequency axis) on the Braun tube. The frequency span is set arbitrarily from a broad band to narrow band with the frequency scale which is calibrated accurately.

Zero Span

A spectrum analyzer does not sweep the frequency in this mode. Instead, it sweeps an arbitrary frequency taking the ordinates axis as the time axis.

Spurious

The spurious means unnecessary signals. They are classified into the following categories according to the properties of each signal:

Harmonic spurious: This is defined to indicate the harmonic level to be generated by the spectrum analyzer itself (to be generated in the mixer circuit in general) when no-distortion signal is applied to it. At the same time, it means the capacity of the harmonic wave distortion measurement.

Neighborhood spurious: A small spurious generated in the neighborhood of the spectrum analyzer when a pure single spectrum signal is applied to it.

Non-harmonic spurious: Apart from the above two, the spectrum analyzer generates a certain proper frequency as a spurious. This is also called the residual response.

Noise Bandwidth

This is used widely as performance to express the oscillation purity of an oscillator, etc. In the spectrum analyzer itself, the noise is generated in the vicinity of the spectrum on the Braun tube from local oscillator and phase lock loop, thus lowering the analyzing capacity of the analyzer. To compensate, the analyzer defines its own sideband range enabling it to analyze the incoming signal noise sidebands within this range. The spectrum analyzer expresses the noise sideband characteristic as follows:

Example:

-70 dB apart from the carrier by 20 kHz where the IF bandwidth is assumed to be 1 kHz. It is also expressed with the energy which exists within the 1 Hz bandwidth in general (Figure A-2 (b)).

Since this value is -70 dB at the 1 kHz bandwidth when expressed with a 1 Hz bandwidth, the signal within the 1 Hz bandwidth becomes a value which is lower than it by approx. $10 \log 1 \text{ Hz}/1 \text{ kHz}$ (dB), approx. 30 dB. It is then expressed as -100 dB/Hz apart from the carrier by 20 kHz when the IF bandwidth is 1 kHz.

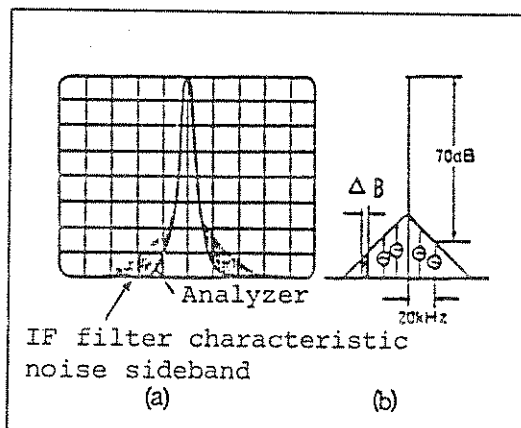

Figure A-2 Noise Sideband

Bandwidth Selectivity

The characteristic of a band-pass filter is not the so-called rectangular characteristic, but it is generally given an attenuation characteristic like a gauss distribution. When two large and small signals are mixed close by, the small signal is concealed behind the large signal (Figure A-3). It is therefore necessary to define the bandwidth in a certain attenuation area (60 dB). For this purpose, the ratio of 3 dB width vs. 60 dB width is expressed as the bandwidth selectivity.

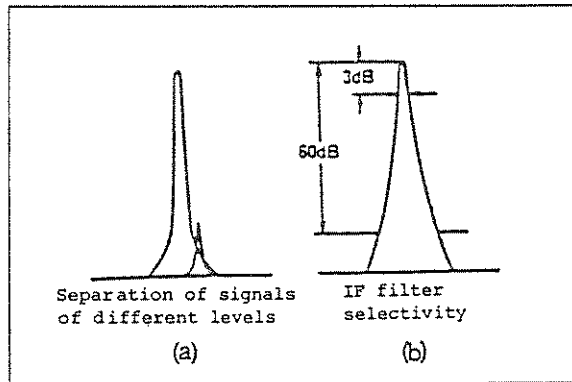

Figure A-3 Bandwidth Selectivity

Bandwidth Accuracy

This is the performance to express the bandwidth accuracy of the IF filter. It is expressed as a deviation of the nominal value at a 3 dB lowering point. Although this performance little affects the level measurement of ordinary continuous signals, it should be taken into consideration for the level measurement of a noise signal.

Bandwidth Switching Accuracy

For dissolving a signal into spectrums, not one but several IF filters are used to obtain the optimum resolution for the scan width. Even when measuring the same signal, an error occurs when the IF filter is switched for a portion having different loss. This is defined as the bandwidth switching accuracy.

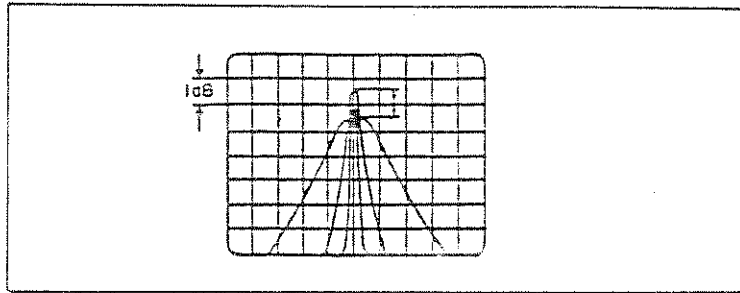

Figure A-4 Bandwidth Switching Accuracy

Reference Level Display Accuracy

In the spectrum analyzer, the absolute level of an input signal is obtained by reading how much the dB is lowered from the upper-most scale on the tube surface as a standard. The level set on this upper-most stage is called the reference level. The reference level is changed by the IF GAIN key and input attenuator and it is expressed in dBm or dBμ. The absolute accuracy of this display becomes the reference level frequency.

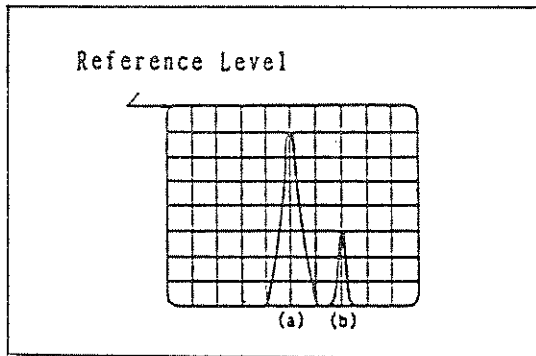

Figure A-5 Reference Level

VSWR: Voltage Standing Wave Ratio

This is a constant which expresses the impedance matching status. It is expressed as the ratio of the maximum value vs. minimum value of the standing wave caused by the composition of the progressive wave and reflected wave, where the spectrum analyzer is loaded to the ideal and nominal impedance source. This is expressed in a different form by the reflection coefficient and reflection loss.

R4131 SERIES
SPECTRUM ANALYZER
INSTRUCTION MANUAL

A.1 Explanation of Terminologies

When signal E_0 sent from the transmission side is completely transmitted to the reception side (the spectrum analyzer input section) without miss-matching in the impedance in Figure A-6, signal E_1 received in the reception side is equivalent in value to E_0 . When not all the signal is transmitted owing to the miss-matching on the reception side and returned by reflection to the reception side, the reflected ratio (the reflection coefficient) can be expressed as follows where the size of the reflected wave is taken as E_R :

Reflection coefficient $m = \text{Reflected wave } E_R / \text{progressive wave } E_0$

The ratio of reflected wave E_R vs progressive wave E_0 becomes the reflected attenuation.

$$\begin{aligned} \text{Reflected attenuation} &= 20 \log E_R / E_0 \text{ (dB) VSWR} \\ &= (E_0 + E_R) / (E_0 - E_R) \end{aligned}$$

Its relation with the reflection coefficient becomes a range of 1 to ∞ in VSWR where the VSWR is assumed to be $\text{VSWR} = (1+|m|) / (1-|m|)$. The closer to 1, the better the matching condition.

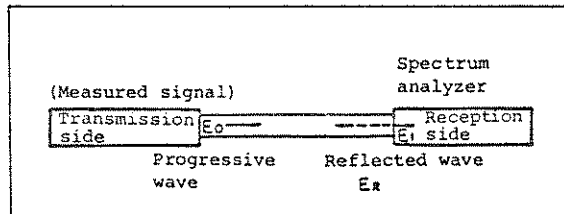

Figure A-6 V.S.W.R.

Spurious Response

When the signal level becomes larger, the harmonic wave is distorted in the input mixer circuit. A range usable with no distortion varies according to the fundamental wave input level. In the example in Figure A-7, it becomes -70 dB for the -30 dBm. When the input signal level is larger, the signal applied to the mixer is made smaller by the input attenuator so that it becomes an optimum input level.

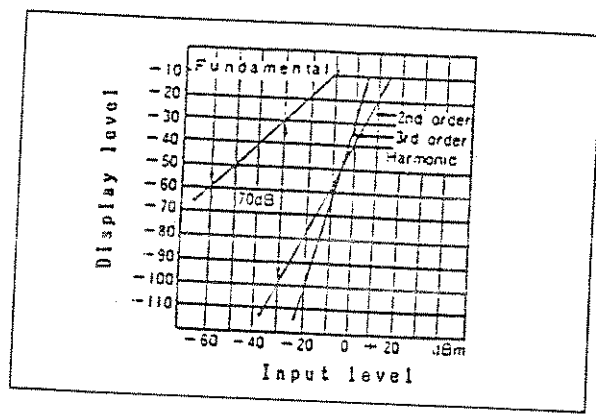

Figure A-7 Spurious Response

YIG-turned Oscillator

This was reported by Griffiths for the first time in 1946. The garnet-series ferrite which represents the (Yttrium Iron Garnet) monocrystal shows a quite sharp electronic spin resonant phenomenon and its resonant frequency has a linear proportional relationship throughout a broad frequency band for the applied DC magnetic field. It is known from this that the broad band electronic tuning is enabled by varying the exciting current of electromagnet which forms the AC magnetic field. This is applied to the spectrum analyzer and to the local sweep generator of the automatic microwave frequency counter of ADVANTEST.

R4131 SERIES
SPECTRUM ANALYZER
INSTRUCTION MANUAL

A.2 Level Conversion Table

A.2 Level Conversion Table

dBm/50Ω, dBm/75Ω, Vrms, W/50Ω, dBμ, dBV Conversion Table

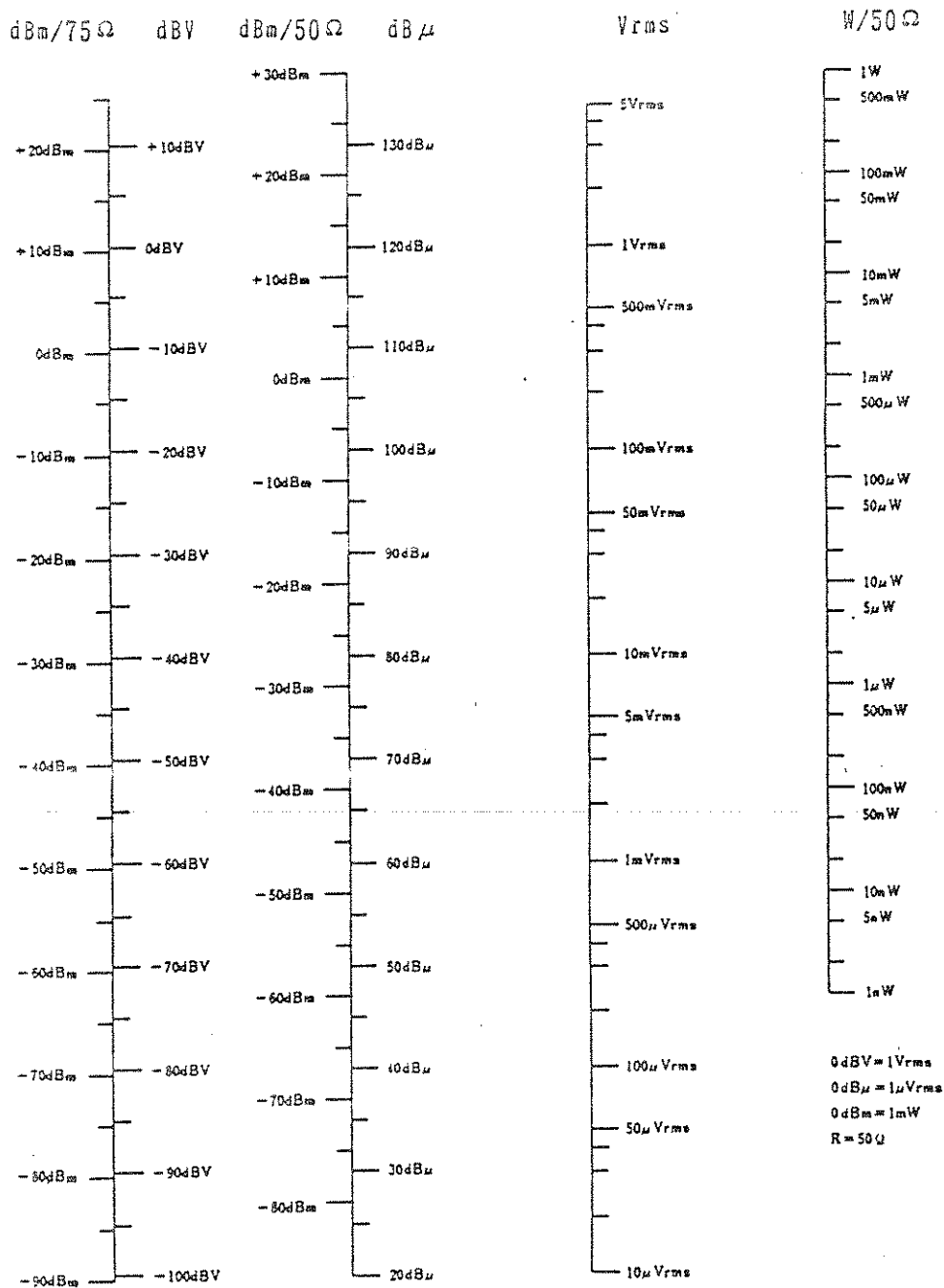

Figure A-8 Level Conversion Table

A.3 Parts Location and Circuit Diagrams

Parts No.	ADVANTEST Stock No.	Parts No.	ADVANTEST Stock No.
C1 -8	CSM-AGR1U50V	R21	RCB-AG1R5K
C9 -12	CCK-AR100U16V	R22	RCB-AG2R7K
C13 -14	CSM-AGR1U50V	R23	RCB-AG10K
C15	CSM-AY1000P50V	R24	RCB-AG27K
C16	CSM-AG1U50V	R25 -26	RAY-AL3R9K8
C17 -19	CSM-AGR1U50V	R27	RCB-AG4R7K
C20	CCK-AR10U16V	R28 -29	RAY-AL3R9K8
C21	CSM-AGR1U50V	R30 -33	RAY-AL47K4
C22	CCK-AR10U16V	R34	RCB-AG82K
C23 -24	CSM-AGR1U50V	R35 -38	RAY-AL3R9K8
C25	CCK-AR10U16V	R39	RCB-AG10K
C26 -30	CSM-AGR1U50V	R40	RCB-AG220
C31	CCK-AR10U16V	R41	RCB-AG680
C32 -40	CSM-AGR1U50V	R42	RCB-AG1R5K
C41	CSM-AY1000P50V	R43 -44	RCB-AG3R3K
C42	CSM-AC470P50V	R45	RCB-AG220
C43 -44	CCK-AR470U10V	R46	RCB-AG68
C45	CCK-AR10U16V	R47	RCB-AG100
C46	CCK-AR470U10V	R48	RCB-AG470
C47	CSM-ACR01U50V	S1	KSA-000691
C48	CCK-AR10U16V	TP1 -4	JTE-AH001JX01
D1 -6	SDS-1SS270	U1	SIM-74HC374
D9 -10	SDS-1SS270	U2	SIM-74HC4538
J1	JCR-AF040PX01	U3	SIM-74HC02
J2	JCP-BH005PX01	U4 -5	SIM-74HC245
J3	JCP-AA012PX05	U6	SIM-74HC125
J4	JCP-BG012PX03	U7	SIM-74HC20
J5	JCR-AF050PX01	U8	SIA-393
J6	JCS-BG024JX05	U10	SIA-TL7700
J7	JCP-BH002PX01	U11	SIM-74HC374
J8	JCI-AH014JX01	U12	SIM-74HC4538
L1 -2	LCL-T00084A	U13	SIM-74HC04
L3	LCL-T00084A	U14	SIM-74HC08
Q1	STP-2SA1015	U15	SIM-74HC245
Q2	STN-2SC2026	U16	SIM-74HC244
Q3	STN-2SC1815	U17	SIM-74HC10
Q4 -5	STN-2SC2026	U18	SIM-74HC32
R1	RCB-AG820	U19	SIM-74HC00
R2	RCB-AG220	U20	SIM-74HC74
R5	RCB-AG560	U21	SMM-27C256B
R6	RCB-AG680	U22	SIM-74HC14
R7	RCB-AG470	U23	SIM-653438
R8	RCB-AG68	U24	SIM-6845C
R9	RCB-AG470	U25	SIM-8254C
R10 -11	RCB-AG680	U26	SMM-8464C
R12	RCB-AG22K	U27	SIM-Z80C
R13 -15	RAY-AL3R9K8	U28	SIM-74HC244
R16	RCB-AG10K	U29	SIM-61VH136
R17	RCB-AG33K	U30	SMM-8422A
R18	RCB-AG4R7K	U31	SIM-8254C
R19	RCB-AG3R3K	U32	SMM-8464C
R20	RCB-AG22K	U33	SIM-9914

Parts No.	ADVANTEST Stock No.	Parts No.	ADVANTEST Stock No.
U34	SIT-75160		
U35	SIT-75161		
U36 -37	SMM-2018B		
U38	SIM-74HC04		
U39	SIM-74HC74		
U40	SMM-27128A		
U41	SIM-8254C		
U42	SMM-2864		
U43	SIM-74HC393		
U44	SIM-74HC04		
X1	DXC-000109		

Parts No.	ADVANTEST Stock No.	Parts No.	ADVANTEST Stock No.
C1	CMC-AP820PR3K	C112	CMC-AP820PR3K
C2	CMC-AP560PR3K	C113-115	CCP-BBR1U50V
C3	CMC-AP1000PR1K	C118-119	CCP-BBR1U50V
C4	CMC-AP560PR3K	C120-123	CCK-CD47U25V
C5	CCP-BAR01U50V	C124-126	CCP-BBR1U50V
C6	CCP-BBR1U50V	C127	CCP-BA100P50V
C7	CCP-BAR01U50V	C128	CCP-BA2200P50V
C8	CCP-BA8P50V	C129	CCP-BBR1U50V
C9	CTM-BM6P	C130	CCK-CD100U35V
C11	CCP-BBR1U50V	C131-149	CCP-BBR1U50V
C12	CCK-CD10U25V	C151-154	CCK-CD47U25V
C13	CCP-BBR1U50V	C155	CCP-BBR1U50V
C14	CCP-BAR01U50V	C157-159	CCP-BBR1U50V
C16	CCP-BBR1U50V	C160	CCK-CD10U25V
C17	CCP-BA8P50V	C161-163	CCP-BBR1U50V
C18	CTM-BM6P	C164-165	CCK-CD10U25V
C19	CCP-BAR01U50V	C166-169	CCP-BBR1U50V
C20 -21	CCP-BBR1U50V	C171	CCP-BA1000P50V
C22 -25	CCP-BAR01U50V	C172	CCP-BBR1U50V
C26 -29	CCP-BBR1U50V	C173	CCK-CD10U25V
C30	CMC-AP1000PR1K	C174	CCP-BBR1U50V
C32	CCP-BBR1U50V	C175	CCP-BA1000P50V
C33 -37	CCP-BAR01U50V	C176-179	CCP-BBR1U50V
C38	CMC-AP1000PR1K	C180	CCP-BA1000P50V
C40 -42	CCP-BBR1U50V	C181	CCK-CD33U10V
C43	CCK-CD10U25V	C182	CCK-CD100U10V
C44	CCP-BBR1U50V	C183-184	CCP-BBR1U50V
C45	CCP-BAR01U50V	C185	CCP-BA1000P50V
C48	CCP-BBR1U50V	C186	CCP-BBR1U50V
C49	CCK-CD10U25V	C187-189	CCK-CD470U10V
C50 -55	CCP-BBR1U50V	C190-194	CCP-BBR1U50V
C56 -59	CCP-BAR01U50V	C196	CCP-BA1000P50V
C60 -65	CCP-BBR1U50V	C197-201	CCP-BBR1U50V
C66	CCP-BAR01U50V	C202-203	CCK-CD47U25V
C67 -68	CCP-BBR1U50V	C204-205	CCK-CD10U25V
C69 -73	CCP-BAR01U50V	C206-209	CCP-BBR1U50V
C74 -82	CCP-BBR1U50V	C210	CFM-AH1U100V
C83	CMC-AP1000PR1K	C211	CCK-CD47U10V
C85 -90	CCP-BAR01U50V	C212	CCP-BAR01U50V
C91	CMC-AP1000PR1K	C213	CCP-BAR01U50V
C93 -94	CCP-BBR1U50V	C214-216	CCP-BBR1U50V
C95	CCK-CD10U25V	C217-219	CCP-BAR01U50V
C96	CCP-BBR1U50V	D1 -10	SDS-1SS279
C97	CCP-BAR01U50V	D12 -35	SDS-1SS279
C98	CCP-BA8P50V	D38 -43	SDS-1SS270
C99	CTM-BM6P	D46	SDZ-M130
C101-105	CCP-BBR1U50V	D47	SDZ-2-1
C106	CCP-BAR01U50V	D48 -52	SDS-1SS270
C107	CCP-BA8P50V	D53	SDS-LD1
C108	CTM-BM6P	J1	JCR-AF050PX02
C110	CCP-BBR1U50V	J2	JCP-BH002PX01
C111	CCP-BAR01U50V	J3	JCP-AA012PX07

arts No.	ADVANTEST Stock No.	Parts No.	ADVANTEST Stock No.
4	JCP-BH010PX01	R4	RCP-AH22K
5	JCR-AF010PX01	R5	RCP-AH470K
5	JCP-BH003PX01	R6	DSP-000015
7 -9	JCF-AC001JX01	R7	RCP-AH100
1	KRL-000874	R8	RCP-AH68
1	LCL-C00554	R10	RCP-AH470
2	LCL-C00490	R11	RMF-AC470QFJ
3	LCL-C00673	R12	RCP-AH100
3	LCL-C00490	R13	RCP-AH15
5	LCL-C00124	R14	RCP-AH33
5	LCL-C00012	R15	RCP-AH22K
7	LCL-C00010	R16	RCP-AH4R7K
8	LCL-C00672	R17	RMF-AC100QFJ
0	LCL-C00010	R18	RCP-AH560
1	LCL-C00672	R19	RMF-AC1KFJ
2 -13	LCL-C00012	R20	RCP-AH3R9K
4 -15	LCL-C00549	R21	RCP-AH2R2K
6	LCL-C00012	R22	RCP-AH18K
8	LCL-B01024	R23	RCP-AH15
8	LCL-B01024	R24	RCP-AH33
0 -22	LCL-C00012	R26	RCP-AH4R7K
3 -24	LCL-C00549	R27	RCP-AH22K
5 -26	LCL-C00010	R28	RMF-AC150QFJ
7 -28	LCL-C00672	R29	RCP-AH560
9	LCL-C00554	R30	RMF-AC1KFJ
0 -32	LCL-C00012	R31	RCP-AH3R9K
3	LCL-B01024	R32	RCP-AH2R2K
5	LCL-B01024	R33	RCP-AH18K
9 -44	LCL-T00084A	R34	RCP-AH470
	SFN-SST4859	R36	RCP-AH330
	STN-2SC1815	R37	RMF-AC1KFJ
	STN-2SC2712	R38	RCP-AH100
	STN-2SC1815	R39	RCP-AH10K
-10	STN-2SC2712	R40	RCP-AH100
1	STN-2SC1815	R41 -42	RCP-AH2R2K
2	STN-2SC2712	R43 -44	RMF-AC2R2KFJ
3	STN-2SC1815	R45	RCP-AH6R8K
4	STN-2SC2712	R46	RCP-AH3R3K
-27	STN-FN1A4P	R47	RCP-AH750
	STP-2SA1162	R48	RCP-AH220
-32	STP-2SA1015	R49	RCP-AH56
	STN-2SC1815	R50 -52	RCP-AH120
-35	SFN-SST4393	R53	RCP-AH390
-37	STN-2SC1983	R54	DSP-000017
	STN-FA1A4P	R55	RCP-AH470
	STP-2SA1162	R56	RCP-AH100
	STN-2SC2712	R57 -58	RCP-AH2R2K
	STN-2SC1815	R59 -60	RMF-AC2R2KFJ
-44	STP-2SA1015	R61	RCP-AH6R8K
	RCP-AH39	R62	RCP-AH3R3K
	RCP-AH56	R63	RCP-AH750
	RCP-AH10K	R64	RCP-AH220

Parts No.	ADVANTEST Stock No.	Parts No.	ADVANTEST Stock No.
R65	RCP-AH56	R134	RCP-AH6R8K
R66	RCP-AH560	R135	RCP-AH3R3K
R68	RCP-AH100	R136	RCP-AH1R2K
R69	RCP-AH150	R137	RCP-AH680
R73	RCP-AH33	R138	RCP-AH220
R74	RCP-AH2R2K	R139	RCP-AH56
R76	RCP-AH1K	R140	RCP-AH560
R77	RCP-AH470	R142	RCP-AH100
R78 -79	RMF-AC1KFJ	R143-144	RCP-AH2R2K
R80	RMF-AC30QFJ	R145-147	RMF-AC2R2KFJ
R82	RMF-AC1KFJ	R148	RCP-AH6R8K
R83	RMF-AC499QFJ	R149	RCP-AH3R3K
R84 -85	RCP-AH2R2K	R150	RCP-AH1R2K
R86	RCP-AH33	R151	RCP-AH680
R87	RCP-AH2R2K	R152	RCP-AH220
R88	RCP-AH68	R153	RCP-AH56
R90	RCP-AH1K	R154	RMF-AC620QFJ
R91	RCP-AH470	R155	DSP-000015
R92	RMF-AC1KFJ	R156-157	RCP-AH100
R93 -94	RCP-AH10K	R158	RCP-AH15
R95	RCP-AH2R7K	R159	RCP-AH33
R96	RMF-AC390QFJ	R160	RCP-AH4R7K
R97	RCP-AH4R7K	R161	RMF-AC150QFJ
R98	RMF-AC220QFJ	R162	RCP-AH22K
R99	RCP-AH2R2K	R163	RCP-AH560
R100-101	RCP-AH10K	R164	RMF-AC1KFJ
R102	RCP-AH2R7K	R165	RCP-AH3R3K
R103	RMF-AC180QFJ	R166	RCP-AH2R2K
R104	RCP-AH1R5K	R167	RCP-AH18K
R105	RMF-AC270QFJ	R168	RCP-AH2R2K
R106	RCP-AH2R2K	R169	RCP-AH220K
R107-108	RCP-AH10K	R170	RCP-AH15
R109	RCP-AH2R7K	R171	RCP-AH33
R110	RMF-AC82QFJ	R173	RCP-AH4R7K
R111	RCP-AH910	R174	RMF-AC150QFJ
R112	RMF-AC301QFJ	R175	RCP-AH22K
R113	RCP-AH2R2K	R176	RCP-AH560
R114-115	RCP-AH10K	R177	RMF-AC1KFJ
R116	RCP-AH2R7K	R178	RCP-AH3R3K
R117	RMF-AC51QFJ	R179	RCP-AH2R2K
R118	RCP-AH270	R180	RCP-AH18K
R119	RMF-AC390QFJ	R181	RCP-AH2R2K
R120	RCP-AH2R2K	R182	RCP-AH220K
R121	RCP-AH33	R183	RCP-AH680
R122	RCP-AH2R2K	R185	RCP-AH470
R124	RCP-AH1K	R186	RMF-AC680QFJ
R125	RCP-AH470	R187	RCP-AH220
R126	RCP-AH820	R188	RCP-AH390
R127	RCP-AH10K	R189	RCP-AH470
R128	RCP-AH100	R190	RMF-AC470QFJ
R129-130	RCP-AH2R2K	R191-192	RCP-AH10K
R131-133	RMF-AC2R2KFJ	R193	RCP-AH56

Parts No.	ADVANTEST Stock No.	Parts No.	ADVANTEST Stock No.
R196-203	RCP-AH47K	R286	RMF-AC8R2KFJ
R204-205	RCP-AH10K	R288	RMF-AC6R2KFJ
R206-211	RCP-AH47K	R290	RCP-AH10K
R212	RCP-AH150	R291	RCP-AH220
R213	RCP-AH62K	R292	RCP-AH1K
R214-219	RCP-AH220	R293	RCP-AH100
R220	RCP-AH1R5K	R294	RCP-AH270
R221	RCP-AH47K	R295-298	RCP-AH100
R222	RCP-AH51	R299	RCP-AH4R7K
R223-224	RCP-AH39	R300	RCP-AH1K
R227-229	RCP-AH10K	R301	RMF-BJ30KFJ
R230	RCP-AH3R3K	R302	RMF-BJ15KFJ
R231	RMF-AC4R7KFJ	R303-304	RMF-BJ7R5KFJ
R233	RMF-AC8R2KFJ	R305	RMF-BJ10KFJ
R234	RMF-AC510QFJ	R306	RMF-BJ1KFJ
R235-237	RCP-AH10K	R307	RMF-BJ110QFJ
R238	RCP-AH3R3K	R309	RMF-BJ10KFJ
R239	RMF-BJ8R2KFJ	R310	RMF-BJ220QFJ
R241	RMF-BJ6R8KFJ	R311	RMF-BJ2R7KFJ
R242-243	RMF-BJ10KFJ	R312	RMF-BJ7R5KFJ
R244	RCP-AH10K	R313	RMF-BJ15KFJ
R245	RCP-AH3R3K	R314	RMF-BJ7R5KFJ
R246-247	RMF-BJ33KFJ	R315	RMF-BJ11KFJ
R248-249	RCP-AH47K	R316	RMF-BJ56QFJ
R250	RCP-AH18K	R318	RMF-BJ4R7KFJ
R251	RCP-AH5R1K	R320	RMF-BJ3KFJ
R252	RCP-AH10K	R321	RCP-AH100K
R254	RCP-AH3R3K	R322	RMF-BJ5R1KFJ
R255	RCP-AH15K	R323	RCP-AH1R5K
R256	RCP-AH10K	R324-332	RCP-AH220
R258	RMF-BJ5R1KFJ	R333-335	RMF-AS330QFK
R259	RMF-BJ10KFJ	R336	RMF-BJ20KFJ
R260	RMF-BJ68KFJ	R337	RMF-BJ10KFJ
R262	RCP-AH820K	R338-340	RCP-AH680
R263	RCP-AH1M	R341	RMF-BJ10KFJ
R264	RMF-BJ5R6KFJ	R342	RMF-BJ12KFJ
R265	RMF-BJ100QFJ	R343	RMF-BJ10KFJ
R266	RCP-AH10K	R344	RMF-BJ12KFJ
R267	RCP-AH12K	R345	RCP-AH12K
R268	RCP-AH1K	R346	RCP-AH3R3K
R271	RMF-BJ11KFJ	R347	RMF-BJ18KFJ
R272	RMF-BJ56QFJ	R348	RMF-BJ12KFJ
R273	RMF-BJ10KFJ	R349	RMF-BJ18KFJ
R274	RMF-AC10KFJ	R350	RMF-BJ7R5KFJ
R275	RMF-AC7R5KFJ	R351	RMF-BJ51KFJ
R276	RMF-BJ330KFJ	R352	RMF-BJ15KFJ
R277	RMF-BJ1KFJ	R353	RMF-BJ7R5KFJ
R278	RMF-BJ30KFJ	R354	RMF-BJ7R5KFJ
R279	RMF-BJ1KFJ	R356	RCP-AH3R3K
R280-283	RMF-BJ5R1KFJ	U1	-2 SHB-001655
R284	RCP-AH220	U3	-4 SHB-001658
R285	RCP-AH1K	U5	SHB-001656

Parts No.	ADVANTEST Stock No.	Parts No.	ADVANTEST Stock No.
U6	-7	SHB-001657	
U8		SHB-001544	
U9	-10	SHB-001543	
U11		SHB-001544	
U12	-14	SHB-001655	
U15		SHB-001656	
U16	-17	SHB-001657	
U18		SHB-001655	
U19	-20	SHB-001658	
U21		SHB-001655	
U22		SHB-001656	
U23		SHB-001543	
U24		SHB-001544	
U25		SHB-001543	
U26		SHB-001544	
U29	-32	SIM-74HC138	
U33		SIM-74HC273	
U34		SIM-74HC174	
U35		SIM-74HC273	
U36	-37	SIM-74HC174	
U38	-40	SIM-74HC74	
U41		SIM-74HC4538	
U42		SIM-74HC04	
U43	-45	SIT-74LS06	
U46		SIA-4558	
U47		SIA-324	
U48		SIM-74HC273	
U51		SIA-OP77P	
U52		SIA-TL082	
U53	-54	SIA-4558	
U55		SIA-393	
U56	-58	SIA-DA7524-4	
U59	-62	SIA-DG201	
U63	-65	SIA-OP77P	
U66		SIA-TL072	
U67		SIA-811	
U68		SIA-811	
U69		SIA-TL072	
U70		SIA-812	
U71		SIA-4558	
U72		SIA-398	
U73		SIA-DG201	
U74		SIA-4558	
U75		SIA-4558	
U76		SIA-811	
X1	-4	DXD-001059	

Parts No.	ADVANTEST Stock No.	Parts No.	ADVANTEST Stock No.
1 -4	CCP-BAR01U50V	C104-105	CCK-CD10U25V
5 -7	CCP-BBR1U50V	C106-107	CCP-BBR1U50V
8 -11	CCP-BAR01U50V	C108	CCP-BA33P50V
12	CMC-AP330PR5K	C109	CFM-AS1000P50V
13 -15	CCP-BAR01U50V	C110-111	CCK-CD10U25V
16	CMC-AP470PR3K	C112-115	CCP-BBR1U50V
17 -24	CCP-BAR01U50V	C116	CCP-BA33P50V
27 -28	CCP-BBR1U50V	C117	CFM-AS2200P50V
29	CCP-BA15P50V	C118-119	CCK-CD10U25V
30	CCP-BBR1U50V	C120-121	CCP-BBR1U50V
31 -32	CCP-BAR01U50V	C122-123	CCP-BA1000P50V
33 -37	CCP-BBR1U50V	C124-125	CCP-BBR1U50V
38	CTA-AC10U16V	C126-127	CCP-BA1000P50V
39	CTA-AC1U35V	C128-129	CCP-BBR1U50V
40	CFM-ASR01U50V	C130	CCP-BA100P50V
41	CMC-AP100PR5K	C131	CCK-CD10U25V
42	CCP-BA330P50V	C132	CCP-BA47P50V
43	CFM-AHR47U100V	C133	CCK-CD22U25V
44 -45	CCP-BBR1U50V	C134-136	CCP-BBR1U50V
46 -47	CTA-AC10U16V	C141-148	CCK-CD47U25V
48 -49	CCP-BAR01U50V	C149-150	CCK-CD47U10V
50 -55	CCP-BBR1U50V	C151-192	CCP-BBR1U50V
56	CCP-BAR01U50V	D1 -2	SDS-1SS270
57	CCP-BA15P50V	D3 -4	SDS-1SS286
58	CCK-CD22U16V	D5 -9	SDS-1SS270
59	CCP-BBR1U50V	D10	SDS-1SS286
60	CFM-AH1U100V	D11	SDS-LD1
61 -66	CCP-BBR1U50V	D12 -17	SDS-1SS270
67	CCP-BAR01U50V	D20	SDZ-M030
68	CFM-ASR022U50V	D21 -23	SDS-LD1
69	CCP-BBR1U50V	D24 -34	SDS-1SS270
70	CCP-BA1000P50V	D35	SDZ-M051
71 -72	CCP-BBR1U50V	D36 -39	SDS-1SS270
73	CCK-CD2R2U50V	D41 -45	SDS-1SS270
74 -75	CCK-CD220U25V	D47	SDS-LD1
76	CCP-BBR1U50V	D48 -50	SDS-1SS270
77	CCK-CD10U25V	D52	SDS-LD1
78	CCP-BBR1U50V	D53 -56	SDS-1SS270
79	CCK-CD10U16V	D59 -60	SDZ-M051
80 -81	CCP-BBR1U50V	D61 -62	SDS-1SS286
82	CCP-BA1000P50V	J1	JCR-AF050PX02
83	CCP-BA220P50V	J2	JCP-BH002PX02
84	CCP-BA1000P50V	J3	JCP-BH010PX02
85	CCP-BBR1U50V	J4	JCF-AC001JX01
86	CCP-BBR1U50V	L2 -4	LCL-T00084A
87	CCP-BA47P50V	L5 -6	LCL-C00014
88	CCK-CD22U25V	Q1	STN-2SC2757
89	CCP-BBR1U50V	Q2 -5	STN-2SC2712
90	CCP-BA330P50V	Q6	STN-2SC2757
91-101	CCP-BBR1U50V	Q7 -8	STP-2SA1462
92	CCP-BA33P50V	Q9	STN-FA1A4P
93	CFM-AS1000P50V	Q10 -11	STN-2SC2757

Parts No.	ADVANTEST Stock No.	Parts No.	ADVANTEST Stock No.
Q12	SFN-SST4859	R47	RCP-AH470
Q13 -14	STN-2SC2712	R48	RCP-AH1R2K
Q15	SFN-SST4393	R49	RCP-AH22K
Q16	STP-2SA1162	R50 -51	RCP-AH1R2K
Q17	STN-2SC2712	R52	RCP-AH6R8K
Q19	STN-2SC2712	R53	RCP-AH3R3K
Q20	STP-2SA1162	R54	RCP-AH1R5K
Q21	SFN-SST4393	R55	RCP-AH10K
Q22	STN-2SC2712	R56	RCP-AH180K
Q23	STP-2SA1162	R58	RMF-BJ1R5KFJ
Q24	SFN-SST4393	R59 -60	RMF-BJ10KFJ
Q25 -31	STN-2SC2712	R61	RMF-BJ3R3KFJ
Q32	STP-2SA1162	R62	RCP-AH100K
Q35	STN-2SC2712	R63	RMF-BJ39KFJ
Q36	STP-2SA1162	R64	RMF-BJ33KFJ
Q39	STP-2SA1162	R66	RMF-BJ100KFJ
Q40	STN-2SC2712	R67	RMF-AC200KFJ
Q41	STP-2SA1162	R68	RMF-BJ1R2KFJ
Q44 -45	STN-2SC2712	R70	RMF-BJ3R9KFJ
Q46	STP-2SA1162	R71	RCP-AH1K
Q49	STN-2SC2712	R73	RMF-AC2R49KFJ
R1	RCP-AH82	R74	RMF-BJ10KFJ
R2	RCP-AH10K	R75	RMF-BJ1R5KFJ
R3	RCP-AH15K	R76 -81	RCP-AH10K
R4	RCP-AH150	R82	RCP-AH1K
R5	RCP-AH1R5K	R83	RCP-AH1M
R6	RCP-AH82	R84	RCP-AH220K
R7	RMF-AC6R2KFJ	R85	RCP-AH820K
R8 -16	RCP-AH18	R86	RCP-AH680K
R17	RCP-AH10K	R87	RCP-AH2R2K
R18	RCP-AH820	R88	RCP-AH680
R19	RCP-AH150	R89	RCP-AH100K
R20 -21	RCP-AH15K	R90	RCP-AH15K
R22	RCP-AH2R2K	R91 -92	RCP-AH27K
R23 -24	RCP-AH51	R93	RCP-AH15K
R25	RCP-AH2R2K	R94	RCP-AH100K
R26 -27	RCP-AH15K	R95	RCP-AH330
R28	RCP-AH12K	R97	RCP-AH100K
R29	RCP-AH10K	R98	RCP-AH330
R30	RCP-AH82	R99 -100	RMF-AC2KFJ
R31 -32	RCP-AH1K	R101	RMF-BJ6R8KFJ
R33	RCP-AH47K	R103	REE-AR510-1
R34	RCP-AH12K	R104	RCP-AH3R9K
R35	RCP-AH390	R105	RCP-AH15K
R36	RCP-AH1K	R106	RMF-BJ15KFJ
R37	RCP-AH150	R107	RMF-BJ10KFJ
R39	RCP-AH82	R108	RMF-BJ20KFJ
R41	RCP-AH390	R110	RMF-BJ68KFJ
R42	RCP-AH47K	R111	RCP-AH15K
R43	RCP-AH18	R112	RCP-AH1M
R44	RCP-AH10K	R113	RCP-AH1K
R45 -46	RCP-AH5R6K	R114	RCP-AH100

Parts No.	ADVANTEST Stock No.	Parts No.	ADVANTEST Stock No.
R115	RCP-AH2R2K	R188	RCP-AH4R7K
R116	RCP-AH47K	R189	RCP-AH15K
R117	RCP-AH10K	R190	RCP-AH1K
R118	RCP-AH220	R191	RCP-AH180K
R119	RCP-AH1M	R192	RCP-AH1K
R120 -121	RCP-AH10K	R193-196	RMF-BJ22KFJ
R122	RCP-AH1K	R197-199	RCP-AH4R7K
R123	RCP-AH150	R200	RCP-AH470
R124 -127	RCP-AH680	R201-202	RCP-AH10K
R128	RCP-AH1K	R203	RCP-AH4R7K
R131	RCP-AH47K	R205	RCP-AH47K
R132	RCP-AH10K	R206	RCP-AH39K
R133	RCP-AH3R9K	R207-218	RCP-AH47K
R134 -135	RCP-AH3R3K	R232	RMF-BJ4R7KFJ
R136 -137	RCP-AH10K	R234	RCP-AH1R8K
R138	RCP-AH100K	R235	RCP-AH4R7K
R139 -140	RCP-AH1M	R236	RCP-AH22
R141	RCP-AH200K	R237-238	RMF-BJ10KFJ
R142 -143	RCP-AH1M	R239	RCP-AH10K
R144	RCP-AH200K	R240	RCP-AH1K
R145	RCB-AK10M	R242	RCP-AH2R2K
R146 -147	RCP-AH27K	R243	RCP-AH100
R149 -150	RCP-AH10K	R244	RCP-AH6R8K
R151	RCP-AH270K	R245	RCP-AH150
R152	RCP-AH47K	R246	RCP-AH6R8K
R153 -156	RCP-AH10K	R247	RCP-AH150
R157	RCP-AH330	R248-249	RCP-AH33
R158	RCP-AH1K	R250	RCP-AH1K
R159	RCP-AH220	R251-252	RCP-AH180
R160	RCP-AH15K	R253	RCP-AH82K
R161	RCP-AH10K	R254-255	RCP-AH2R2K
R162	RMF-BJ10KFJ	R256	RCP-AH4R7K
R163	RMF-BJ12KFJ	R257	RCP-AH1K
R164	RMF-BJ5R6KFJ	R259	RCP-AH2R2K
R165	RMF-BJ2R2KFJ	R260	RCP-AH100
R166	RCP-AH1M	R261	RCP-AH6R8K
R167	RCP-AH180K	R262	RCP-AH150
R168	RCP-AH220K	R263	RCP-AH6R8K
R169	RCP-AH270K	R264	RCP-AH150
R170-171	RCP-AH15K	R265-266	RCP-AH33
R172	RCP-AH100K	R267-268	RCP-AH180
R173	RCP-AH3R9K	R269	RCP-AH100K
R174-175	RCP-AH100K	R270	RCP-AH3R3K
R176	RCP-AH47K	R271	RCP-AH2R2K
R177	RCP-AH100K	R272	RCP-AH4R7K
R178	RMF-BJ10KFJ	R273	RCP-AH1K
R179	RCP-AH47K	R274	RCP-AH100
R180	RCP-AH10K	R276	RCP-AH100
R181	RCP-AH180	R278	RCP-AH2R2K
R182-184	RCP-AH47K	R279	RCP-AH100
R185	RCP-AH100	R280	RCP-AH6R8K
R186-187	RCP-AH47K	R281	RCP-AH150

Parts No.	ADVANTEST Stock No.	Parts No.	ADVANTEST Stock No.
R282	RCP-AH6R8K	U58 -60	SIA-2525D
R283	RCP-AH150	U61 -62	SIA-393
R284-285	RCP-AH33	U63 -64	SIA-311N
R286	RCP-AH1K	U65 -66	SIM-74HC74
R287-288	RCP-AH180	U67	SIM-74HC4538
R289	RCP-AH100K	U68	SIM-74HC139
R290	RCP-AH3R3K	U69	SIM-74HC157
R291	RCP-AH8R2K	U70	SIM-74HC00
R292	RCP-AH4R7K	U71	SIM-74HC08
R293-294	RCP-AH10K	U72	SIA-6012
R295	RCP-AH3R3K	U73	SIA-311N
R297	RCP-AH4R7K	U74	SIM-74C905
R298-300	RCP-AH10K	U75	SIM-74HC08
R301	RCP-AH3R3K	U76	SIM-74HC30
R303	RCP-AH4R7K	U77	SIM-74HC574
R304	RCP-AH15K	U78	SIM-74HC107
R305-306	RMF-BJ10KFJ	U79	SIM-74HC175
R307	RCP-AH22	U80	SIM-74HC74
R309	RMF-AC16KFJ	U81	SIM-74HC04
R311	RMF-BJ1R2KFJ	U82	SIM-74HC02
R312-313	RCP-AH1K	U83	SIM-74HC00
U1 -9	SHB-001464	U84	SIA-DG201
U11	SIA-TL072		
U13 -16	SIA-TL072		
U17	SIA-HA1127		
U18	SIA-4558		
U19	SIA-4066		
U21 -22	SIA-TL082		
U23	SIA-4558		
U24	SIA-393		
U25	SIM-74HC4538		
U26	SIM-74HC03		
U27	SIM-74HC00		
U28	SIM-74HC74		
U29	SIA-4066		
U31 -33	SIM-74HC138		
U34 -37	SIM-74HC174		
U38	SIT-DN8650		
U39 -40	SIT-74LS06		
U41 -42	SIM-74HC74		
U45	SIA-6012		
U46	SIA-REF01D		
U47	SIA-311N		
U48	SIM-74HC107		
U49	SIM-74HC175		
U50 -51	SIM-74HC393		
U52	SIM-74HC574		
U53	SIM-74HC74		
U54	SIM-74HC125		
U55	SIM-74HC02		
U56	SIM-74HC32		
U57	SIM-74HC04		

Parts No.	ADVANTEST Stock No.	Parts No.	ADVANTEST Stock No.
C1 -4	CCP-BAR01U50V	C103	CFM-AS1000P50V
C5 -7	CCP-BBR1U50V	C104-105	CCK-CD10U25V
C8 -11	CCP-BAR01U50V	C112-113	CCP-BBR1U50V
C12	CMC-AP330PR5K	C130	CCP-BA100P50V
C13 -15	CCP-BAR01U50V	C131	CCK-CD10U25V
C16	CMC-AP470PR3K	C132	CCP-BA47P50V
C17 -24	CCP-BAR01U50V	C133	CCK-CD22U25V
C25 -26	CMC-AP22PR5K	C134-136	CCP-BBR1U50V
C27 -28	CCP-BBR1U50V	C141-148	CCK-CD47U25V
C29	CCP-BA15P50V	C149-150	CCK-CD47U10V
C30	CCP-BBR1U50V	C151-193	CCP-BBR1U50V
C31 -32	CCP-BAR01U50V	C194	CFM-AS2200P50V
C33 -37	CCP-BBR1U50V	D1 -2	SDS-1SS270
C38	CFM-ASR022U50V	D3 -4	SDS-1SS286
C39	CFM-AS2200P50V	D5 -9	SDS-1SS270
C40	CMC-AP820PR3K	D10	SDS-1SS286
C41	CMC-AP220PR5K	D11	SDS-LD1
C42	CCP-BA330P50V	D12 -13	SDS-1SS270
C43	CFM-AHR47U100V	D15 -17	SDS-1SS270
C44 -45	CCP-BBR1U50V	D20	SDZ-M030
C46 -47	CTA-AC10U16V	D21 -23	SDS-LD1
C48 -49	CCP-BAR01U50V	D24 -34	SDS-1SS270
C50 -55	CCP-BBR1U50V	D35	SDZ-M051
C56	CCP-BAR01U50V	D36 -39	SDS-1SS270
C57	CCP-BA15P50V	D41 -45	SDS-1SS270
C61	CCK-CD22U16V	D47	SDS-LD1
C62	CCP-BBR1U50V	D60	SDZ-M051
C63	CFM-AH1U100V	D61 -62	SDS-1SS286
C64 -66	CCP-BBR1U50V	J1	JCR-AF050PX02
C67	CCP-BAR01U50V	J2	JCP-BH002PX02
C68	CFM-ASR022U50V	J3	JCP-BH010PX02
C69	CCP-BBR1U50V	J4	JCF-AC001JX01
C70	CCP-BA1000P50V	L2 -4	LCL-T00084A
C71 -72	CCP-BBR1U50V	L5 -6	LCL-C00014
C73	CCK-CD2R2U50V	Q1	STN-2SC2757
C74 -75	CCK-CD220U25V	Q2 -5	STN-2SC2712
C76	CCP-BBR1U50V	Q6	STN-2SC2757
C77	CCK-CD10U25V	Q7 -8	STP-2SA1462
C78	CCP-BBR1U50V	Q9	STN-FA1A4P
C79	CCK-CD10U16V	Q10 -11	STN-2SC2757
C80 -81	CCP-BBR1U50V	Q12	SFN-SST4859
C82	CCP-BA1000P50V	Q13 -14	STN-2SC2712
C83	CCP-BA220P50V	Q15	SFN-SST4393
C84	CCP-BA1000P50V	Q16	STP-2SA1162
C85 -86	CCP-BBR1U50V	Q17	STN-2SC2712
C91 -95	CCP-BBR1U50V	Q19	STN-2SC2712
C96	CCP-BA47P50V	Q20	STP-2SA1162
C97	CCK-CD22U25V	Q21	SFN-SST4393
C98	CCP-BBR1U50V	Q22	STN-2SC2712
C99	CCP-BA330P50V	Q23	STP-2SA1162
C100-101	CCP-BBR1U50V	Q24	SFN-SST4393
C102	CCP-BA33P50V	Q25 -31	STN-2SC2712

Parts No.	ADVANTEST Stock No.	Parts No.	ADVANTEST Stock No.
Q32	STP-2SA1162	R66	RMF-BJ100KFJ
Q33	SFN-SST4859	R67	RMF-AC200KFJ
Q35	STN-2SC2712	R68	RMF-BJ1R2KFJ
Q36	STP-2SA1162	R70	RMF-BJ3R9KFJ
Q38	SFT-SST406S	R71	RCP-AH1K
Q39	STP-2SA1162	R73	RMF-AC2R49KFJ
R1	RCP-AH82	R74	RMF-BJ10KFJ
R2	RCP-AH10K	R75	RMF-BJ680KFJ
R3	RCP-AH15K	R76 -81	RCP-AH10K
R4	RCP-AH150	R82	RCP-AH1K
R5	RCP-AH1R5K	R83	RCP-AH1M
R6	RCP-AH82	R84	RCP-AH220K
R7	RMF-AC6R2KFJ	R85	RCP-AH820K
R8 -16	RCP-AH18	R86	RCP-AH680K
R17	RCP-AH10K	R87	RCP-AH2R2K
R18	RCP-AH820	R88	RCP-AH680
R19	RCP-AH150	R89	RCP-AH100K
R20 -21	RCP-AH15K	R90	RCP-AH15K
R22	RCP-AH2R2K	R91 -92	RCP-AH27K
R23 -24	RCP-AH51	R93	RCP-AH15K
R25	RCP-AH2R2K	R94	RCP-AH100K
R26 -27	RCP-AH15K	R95	RCP-AH330
R28	RCP-AH12K	R97	RCP-AH100K
R29	RCP-AH10K	R98	RCP-AH330
R30	RCP-AH82	R99 -100	RMF-AC2KFJ
R31 -32	RCP-AH1K	R101	RMF-BJ6R8KFJ
R33	RCP-AH47K	R103	REE-AR510-1
R34	RCP-AH12K	R104	RCP-AH3R9K
R35	RCP-AH390	R105	RCP-AH15K
R36	RCP-AH1K	R106	RMF-BJ15KFJ
R37	RCP-AH150	R107	RMF-BJ10KFJ
R39	RCP-AH82	R108	RMF-BJ20KFJ
R41	RCP-AH390	R110	RMF-BJ68KFJ
R42	RCP-AH47K	R111	RCP-AH15K
R43	RCP-AH18	R112	RCP-AH1M
R44	RCP-AH10K	R113	RCP-AH1K
R45 -46	RCP-AH5R6K	R114	RCP-AH100
R47	RCP-AH470	R115	RCP-AH2R2K
R48	RCP-AH1R2K	R116	RCP-AH47K
R49	RCP-AH22K	R117	RCP-AH10K
R50 -51	RCP-AH1R2K	R118	RCP-AH220
R52	RCP-AH6R8K	R119	RCP-AH1M
R53	RCP-AH3R3K	R120-121	RCP-AH10K
R54	RCP-AH1R5K	R122	RCP-AH1K
R55	RCP-AH10K	R123	RCP-AH150
R56	RCP-AH180K		
R58	RMF-BJ1R5KFJ		
R59 -60	RMF-BJ10KFJ		
R61	RMF-BJ3R3KFJ		
R62	RCP-AH100K		
R63	RMF-BJ39KFJ		
R64	RMF-BJ33KFJ		

Parts No.	ADVANTEST Stock No.	Parts No.	ADVANTEST Stock No.
R124-127	RCP-AH680	R197-199	RCP-AH4R7K
R128	RCP-AH1K	R200	RCP-AH470
R129	RCP-AH100K	R201-202	RCP-AH10K
R130	RMF-BJ680QFJ	R203	RCP-AH4R7K
R131	RCP-AH47K	R205	RCP-AH47K
R132	RCP-AH10K	R206	RCP-AH39K
R133	RCP-AH3R9K	R207-211	RCP-AH47K
R134-135	RCP-AH3R3K	R213-218	RCP-AH47K
R136-137	RCP-AH10K	R232	RMF-BJ4R7KFJ
R138	RCP-AH100K	R234	RCP-AH1R8K
R139-140	RCP-AH1M	R235	RCP-AH4R7K
R141	RCP-AH200K	R236	RCP-AH22
R142-143	RCP-AH1M	R237-238	RMF-BJ10KFJ
R144	RCP-AH200K	R239	RCP-AH10K
R145	RCB-AK10M	R240	RCP-AH1K
R146-147	RCP-AH27K	R242	RCP-AH2R2K
R149-150	RCP-AH10K	R243	RCP-AH100
R151	RCP-AH270K	R244	RCP-AH6R8K
R152	RCP-AH47K	R245	RCP-AH150
R153-156	RCP-AH10K	R246	RCP-AH6R8K
R157	RCP-AH330	R247	RCP-AH150
R158	RCP-AH1K	R248-249	RCP-AH33
R159	RCP-AH220	R250	RCP-AH1K
R160	RCP-AH15K	R251-252	RCP-AH180
R161	RCP-AH10K	R253	RCP-AH82K
R162	RMF-BJ10KFJ	R254	RCP-AH2R2K
R163	RMF-BJ12KFJ	R255	RCP-AH1K
R164	RMF-BJ5R6KFJ	R256	RCP-AH4R7K
R165	RMF-BJ2R2KFJ	R304	RCP-AH15K
R166	RCP-AH1M	R305-306	RMF-BJ10KFJ
R167	RCP-AH180K	R307	RCP-AH22
R168	RCP-AH220K	R309	RMF-AC16KFJ
R169	RCP-AH270K	R311	RMF-BJ1R2KFJ
R170-171	RCP-AH15K	R312-313	RCP-AH1K
R172	RCP-AH100K	R314	RMF-BJ3KFJ
R173	RCP-AH3R9K	R315	RMF-BJ2KFJ
R174-175	RCP-AH100K	R318	RCP-AH22
R176	RCP-AH47K	U1 -9	SHB-001464
R177	RCP-AH100K	U10	SIA-318C
R178	RMF-BJ10KFJ	U11	SIA-TL072
R179	RCP-AH47K	U12	SIA-318C
R180	RCP-AH10K	U13 -16	SIA-TL072
R181	RCP-AH180	U17	SIA-HA1127
R182-184	RCP-AH47K	U18	SIA-4558
R185	RCP-AH100	U19	SIA-4066
R186-187	RCP-AH47K	U20	SIA-4558
R188	RCP-AH4R7K	U21 -22	SIA-TL082
R189	RCP-AH15K	U23	SIA-4558
R190	RCP-AH1K	U24	SIA-393
R191	RCP-AH180K	U25	SIM-74HC4538
R192	RCP-AH1K	U26	SIM-74HC03
R193-196	RMF-BJ22KFJ	U27	SIM-74HC00

Parts No.	ADVANTEST Stock No.	Parts No.	ADVANTEST Stock No.
U28	SIM-74HC74		
U29	SIA-4066		
U31 -33	SIM-74HC138		
U34	SIM-74HC174		
U35	SIM-74HC273		
U36 -37	SIM-74HC174		
U38	SIT-DN8650		
U39 -40	SIT-74LS06		
U41 -42	SIM-74HC74		
U45	SIA-6012		
U46	SIA-REF01D		
U47	SIA-311N		
U48	SIM-74HC107		
U49	SIM-74HC175		
U50 -51	SIM-74HC393		
U52	SIM-74HC574		
U53	SIM-74HC74		
U54	SIM-74HC125		
U56	SIM-74HC32		
U57	SIM-74HC04		
U58	SIA-2525D		
U61	SIA-393		
U66	SIM-74HC74		
U67	SIM-74HC4538		
U71	SIM-74HC08		
U72	SIA-6012		
U73	SIA-311N		
U74	SIM-74C905		
U75	SIM-74HC08		
U76	SIM-74HC30		
U77	SIM-74HC574		
U78	SIM-74HC107		
U79	SIM-74HC175		
U80	SIM-74HC74		
U81	SIM-74HC04		
U82	SIM-74HC02		
U83	SIM-74HC00		
U85	SIA-DG201		
U88	SIM-74HC32		
U89	SIA-398		

Parts No.	ADVANTEST Stock No.	Parts No.	ADVANTEST Stock No.
D1	NLD-000111		
D2 -11	NLD-000010		
D12	NLD-000111		
D13 -17	NLD-000010		
D18 -75	SDS-1SS270		
J1	DCB-RR0726X02-1		
R1 -17	RCB-AG820		
S1 -29	KSP-000609		

Parts No.	ADVANTEST Stock No.	Parts No.	ADVANTEST Stock No.		
C1	-2	CCP-BA1000P50V	L14	LCL-C00010	
C3		CCP-BA1P50V	L15	LCL-A00066	
C4		CCP-BAR01U50V	L20	LCL-A00066	
C5		CCP-BA7P50V	M1	-2	DEE-000736
C6		CCP-BA100P50V	Q1	STN-2SC2759	
C7	-9	CCP-BAR01U50V	Q2	-3	STN-2SC2757
C10		CCK-CD22U16V	Q4	STN-2SC2759	
C11		CCP-BA10P50V	Q5	STN-2SC2757	
C12	-14	CCP-BAR01U50V	Q6	STP-2SA1226	
C15		CCK-CD10U25V	R1	RCP-AJ56	
C16	-17	CCP-BA15P50V	R2	RCP-AJ10K	
C18		CCP-BA27P50V	R3	RCP-AJ5R6K	
C19		CCP-BA5P50V	R4	RCP-AJ33	
C20		CTM-BM6P	R5	RCP-AJ220	
C21		CCP-BA7P50V	R6	RCP-AJ33	
C22		CCP-BAR01U50V	R7	RCP-AJ470	
C23		CCK-CD10U25V	R8	-9	RCP-AJ56
C24	-25	CCP-BAR01U50V	R10	RCP-AJ10K	
C26		CCP-BA100P50V	R11	RCP-AJ5R6K	
C27		CCP-BA47P50V	R12	RCP-AJ33	
C28		CCP-BAR01U50V	R13	RCP-AJ470	
C29		CCK-CD10U25V	R14	REE-AS47	
C30		CCP-BA100P50V	R16	RCP-AJ220	
C31		CCP-BA33P50V	R17	RCP-AJ10K	
C32		CCP-BA5P50V	R18	RCP-AJ33	
C33		CCP-BA2P50V	R19	RCP-AJ5R6K	
C34		CCP-BA33P50V	R20	RCP-AJ220	
C35		CCP-BA3P50V	R21	RCP-AJ15	
C36		CTM-BM10P	R22	-23	RCP-AJ680
C37		CCP-BA33P50V	R24	RCP-AJ56	
C38		CCP-BA7P50V	R25	RCP-AJ180	
C39		CCP-BA2P50V	R26	RCP-AJ10	
C40		CCP-BA33P50V	R28	RCP-AJ100	
C41		CCP-BA7P50V	R29	RCP-AJ2R2K	
C42		CCP-BA5P50V	R30	RCP-AJ1R2K	
CB1		DCB-FQ0973X05A-1	R31	RCP-AJ560	
D1		SDS-1SV34	R32	RCP-AJ2R2K	
D2		SDZ-M110	R33	-34	RCP-AJ10K
FB1		DEE-001484	R35	RCP-AJ1R2K	
FL1		DNF-001089	X1	DXD-001084	
J1	-3	JCP-AA003PX05	X2	DXD-001083	
L1		LCL-E00940			
L2		LCL-E00388			
L3		LCL-E00936			
L4	-5	LCL-E00942			
L6	-7	LCL-E00960			
L8		LCL-C00102			
L9		LCL-E00388			
L10		LCL-C00010			
L11		LCL-E00936			
L12		LCL-E00940			
L13		LCL-C00329			

Parts No.	ADVANTEST Stock No.	Parts No.	ADVANTEST Stock No.
C1	CCP-ADR47U50V		
K1 -3	KRL-000350		
R1	RCP-AM91		
R2	RCP-AM68		
R3	RCP-AM91		
R4	RCP-AM62		
R5	RCP-AL120		
R6	RCP-AL130		
R7 -8	RCP-AM62		
R9	RCP-AL120		
R10	RCP-AL130		
R11	RCP-AM62		

Parts No.	ADVANTEST Stock No.	Parts No.	ADVANTEST Stock No.
D1 R1 -3	SDS-DMJ4317-1 RCP-AJ100		

Parts No.	ADVANTEST Stock No.	Parts No.	ADVANTEST Stock No.
R1 -2	RCP-AJ100		

Parts No.	ADVANTEST Stock No.	Parts No.	ADVANTEST Stock No.
C1	-2	CCP-AC100P50V	
C3	-4	CCP-ACR01U50V	
C5		CCP-ADR47U50V	
C6	-8	CCP-ACR01U50V	
C9		CCP-AC15P50V	
C10		CCP-AC1000P50V	
C11	-12	CCP-ACR01U50V	
C13		CCP-AC2P50V	
D1		SDS-ND587T	
L1		LCL-E00932	
L3		LCL-A00671	
L4		LCL-E00934	
L5		LCL-E00939	
L6		LCL-E00388	
Q1		SFN-2SK571	
Q2		STN-2SC2585	
Q3		STN-2SC3356	
R1	-2	RCP-AJ100	
R3		RCP-AJ82	
R4		RCP-AJ1K	
R5		RCP-AJ100K	
R6		RCP-AJ2R7K	
R7		RCB-AG10K	
R8		RCP-AJ100	
R9		RCP-AJ62	
R10		RCP-AJ100	
R11		RCP-AJ680	
R12	-13	RCP-AJ2R2K	
R14		RCB-AQ330	
R15		RCP-AJ10K	
R16		RCP-AJ3R3K	
R17		RCP-AJ8R2	
R18		RCP-AJ220	
R19		RCP-AJ180	
U1		SHB-001697	
Y1	-2	DXD-000792	
Y3		DXD-001050	

Parts No.	ADVANTEST Stock No.	Parts No.	ADVANTEST Stock No.
B1	DMF-001496		
CB1	DCB-FF1223X03-1		
CB2	DCB-FF1223X12-1		
CB3	DCB-FF2023X32-1		
CB4	DCB-FF2023X26-1		
CB6	DCB-FF2680X15-1		
CB7	DCB-QQ2805X01-1		
CB8	DCB-RR2791X04-1		
CB9	DCB-QF2802X01-1		
CB10	DCB-QF2803X01-1		
CB11	DCB-QF2804X01-1		
CB12	DCB-QF2801X01-1		
CB13	DCB-QQ2799X01-1		
CB14	DCB-QS2800X01-1		
J1	JCI-AF003JX05-3		
J2	JCF-AB001JX03		
J6	JCS-AV004JX01		
J8	JCD-AV003PX01		
NF1	DEE-001427		
P1	JTE-AG001EX01		
R1	RVR-BA10K		
R2	RVR-BL200K		
V1	AAA-ME5813A		

Parts No.	ADVANTEST Stock No.	Parts No.	ADVANTEST Stock No.
FL1 -7 J1 -2 J3	DNF-001052 JCF-AA001JX01 YEE-000868-1		

Parts No.	ADVANTEST Stock No.	Parts No.	ADVANTEST Stock No.
FL1 -10	DNF-001052		
J1	JCF-AF001JX09-1		
J2	JCF-AA001JX39-1		
J3	JCF-AA001JX01		
J4	JCF-AA001JX06-1		
J5 -6	JCF-AA001JX01		
J7 -9	JCF-AC001JX02		
J11	JCR-AE010JX02		
J12	JCS-BZ010JX01		

Parts No.	ADVANTEST Stock No.	Parts No.	ADVANTEST Stock No.
CB1	DCB-FF0934X07-1		
CB2	DCB-FF0934X09-1		
CB3	DCB-FF2680X08-1		
FL1 -10	DNF-OQ1052		
J2	JCF-AA001JX39-1		
J3	JCF-AA001JX01		
J4	JCF-AA001JX06-1		
J5 -6	JCF-AA001JX01		
J7 -9	JCF-AC001JX02		
J11	JCR-AE010JX02		
J12	JCS-BZ010JX01		
B1	DMF-001496		
CB1	DCB-FF2416X01-1		
CB2	DCB-FF1223X12-1		
CB3	DCB-FF2023X32-1		
CB4	DCB-FF2023X26-1		
CB5	DCB-FF0934X16-1		
CB6	DCB-FF2680X15-1		
J1	JCI-AF003JX05-3		
J2	JCF-AB001JX03		
J3	JCF-AB001JX03		
J6 -5	JCS-AV004JX01		
J8	JCD-AV003PX01		
NF1	DEE-001427		
P1	JTE-AG001EX01		
R1	RVR-BA10K		
R2	RVR-BL200K		
V1	AAA-ME5813A		

Parts No.	ADVANTEST Stock No.	Parts No.	ADVANTEST Stock No.
C1	CCP-AC100P50V	J2 -5	JCF-AB001JX03
C2 -3	CCP-ACR01U50V	J6	JCS-AV004JX01
C4	CCP-AC100P50V	J8	JCD-AV003PX01
C5 -6	CCP-ACR01U50V	NF1	DEE-001427
C7	CCP-AC100P50V	P1	JTE-AG001EX01
C8 -9	CCP-ACR01U50V	R1	RVR-BA10K
C10	CCP-AC1000P50V	R2	RVR-BL200K
C11	CCP-ACR01U50V	V1	AAA-ME5813A
C12	CCP-AC1000P50V		
C13 -14	CCP-ACR01U50V		
C15	CCP-AC4700P50V		
C16	CCP-ADR1U50V		
L1 -2	LCL-A00670		
Q1 -2	SFN-2SK878		
R1 -2	RCP-AJ100		
R3 -4	RCP-AJ39		
R5 -6	RCP-AJ560		
R7 -8	RCP-AJ39		
R9	RCP-AJ1K		
R10	RCP-AJ120		
R11	RCP-AJ82		
R12	RCP-AJ2R7K		
R13	RCP-AJ100K		
R14	RCB-AG10K		
R15 -16	RCP-AJ39		
R17 -18	RCP-AJ560		
R19 -20	RCP-AJ39		
R21	RCP-AJ1K		
R22	RCP-AJ68		
R23	RCP-AJ51		
R24	RCP-AJ100K		
R25	RCP-AJ10K		
U1 -2	SHB-001697		
U3	SIM-2833		
U4	SIC-566		
U5	SIC-50106CF-1		
B1	DMF-001496		
CB1	DCB-FF1223X03-1		
CB2	DCB-FF1223X12-1		
CB3	DCB-FF2023X32-1		
CB4	DCB-FF2023X26-1		
CB5	DCB-FF0934X16-1		
CB6	DCB-FF2680X15-1		
CB7	DCB-QQ2805X01-1		
CB8	DCB-RR2791X04-1		
CB9	DCB-QF2802X01-1		
CB10	DCB-QF2803X01-1		
CB11	DCB-QF2804X01-1		
CB12	DCB-QF2801X01-1		
CB13	DCB-QQ2799X01-1		
CB14	DCB-QS2800X01-1		
J1	JCI-AF003JX05-3		

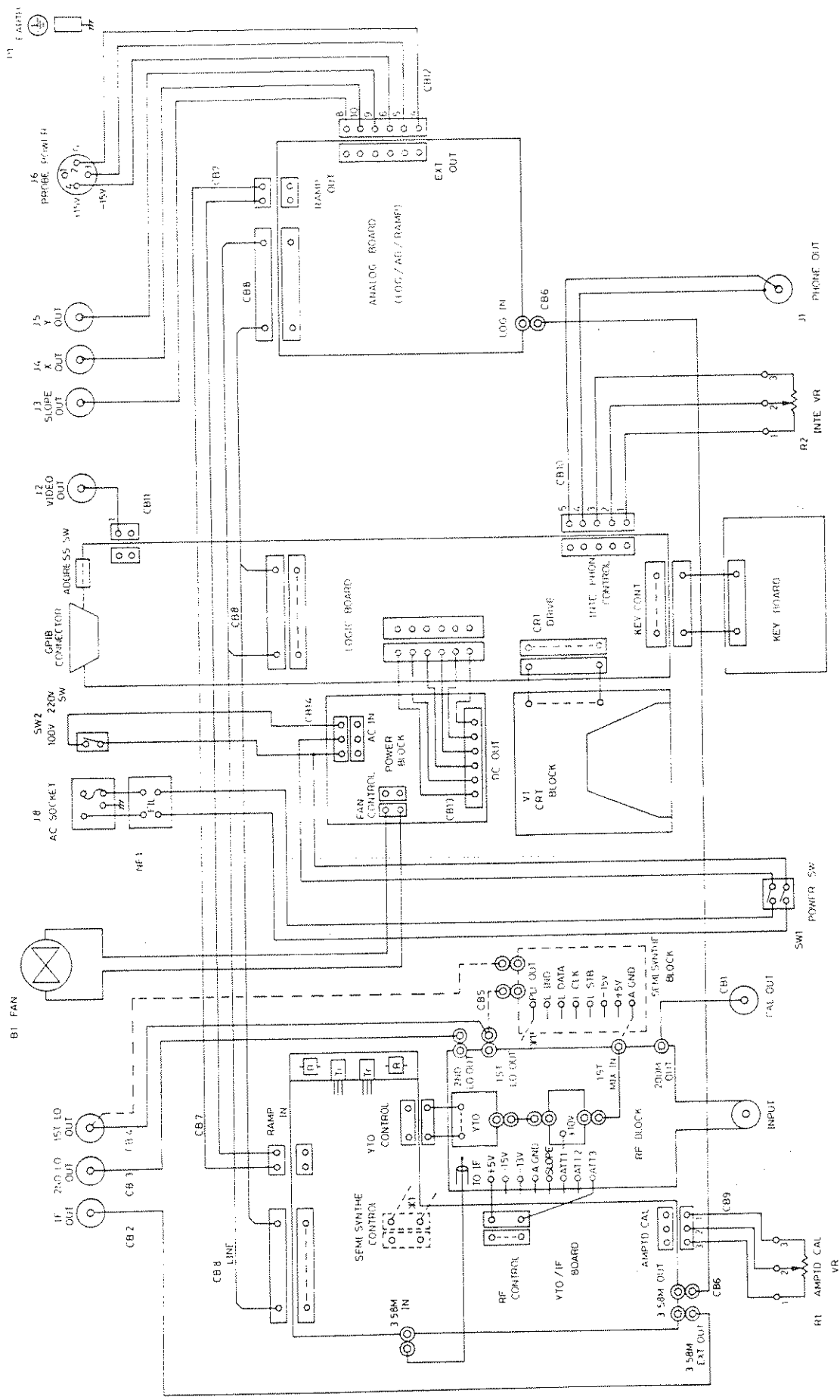

R4131 SERIES
SCHEMATIC SECTION
WFU-4131AE/ANE/BE/BNE

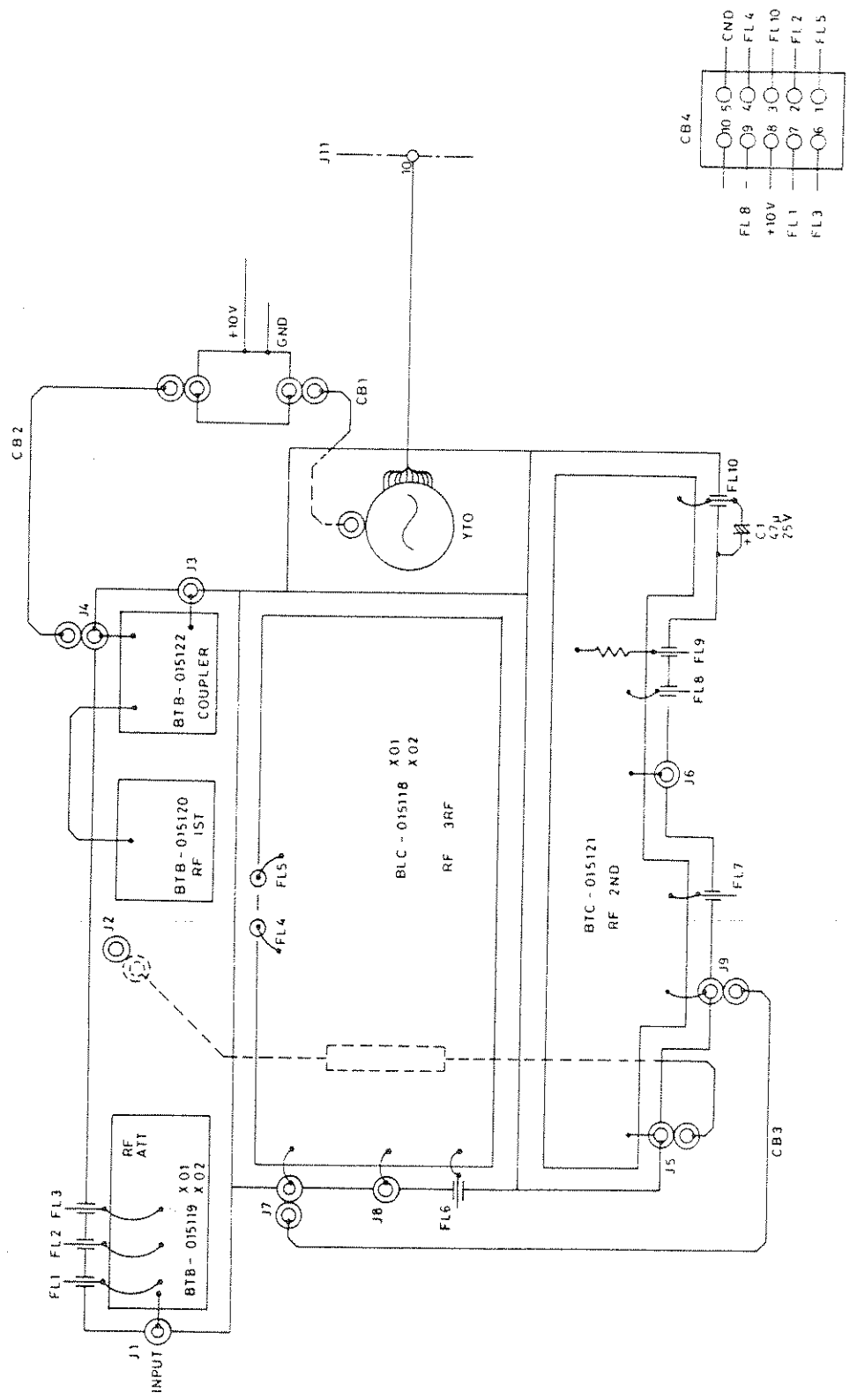

R4131 SERIES
 RF BLOCK
 WBL-4131ARF/BNRI

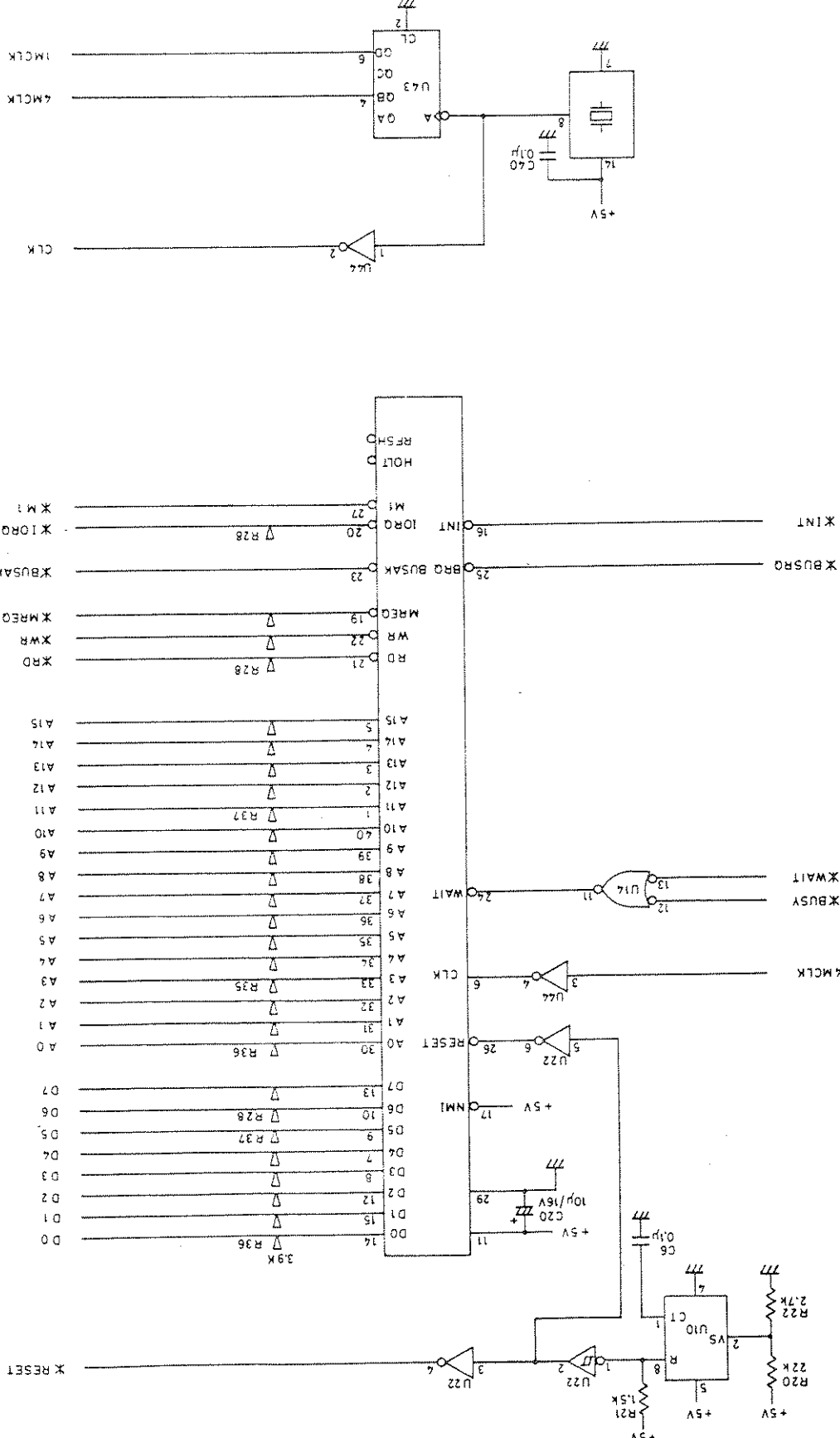

R4131 SERIES
 LOGIC
 BLR-015114 1/14
 A - 39

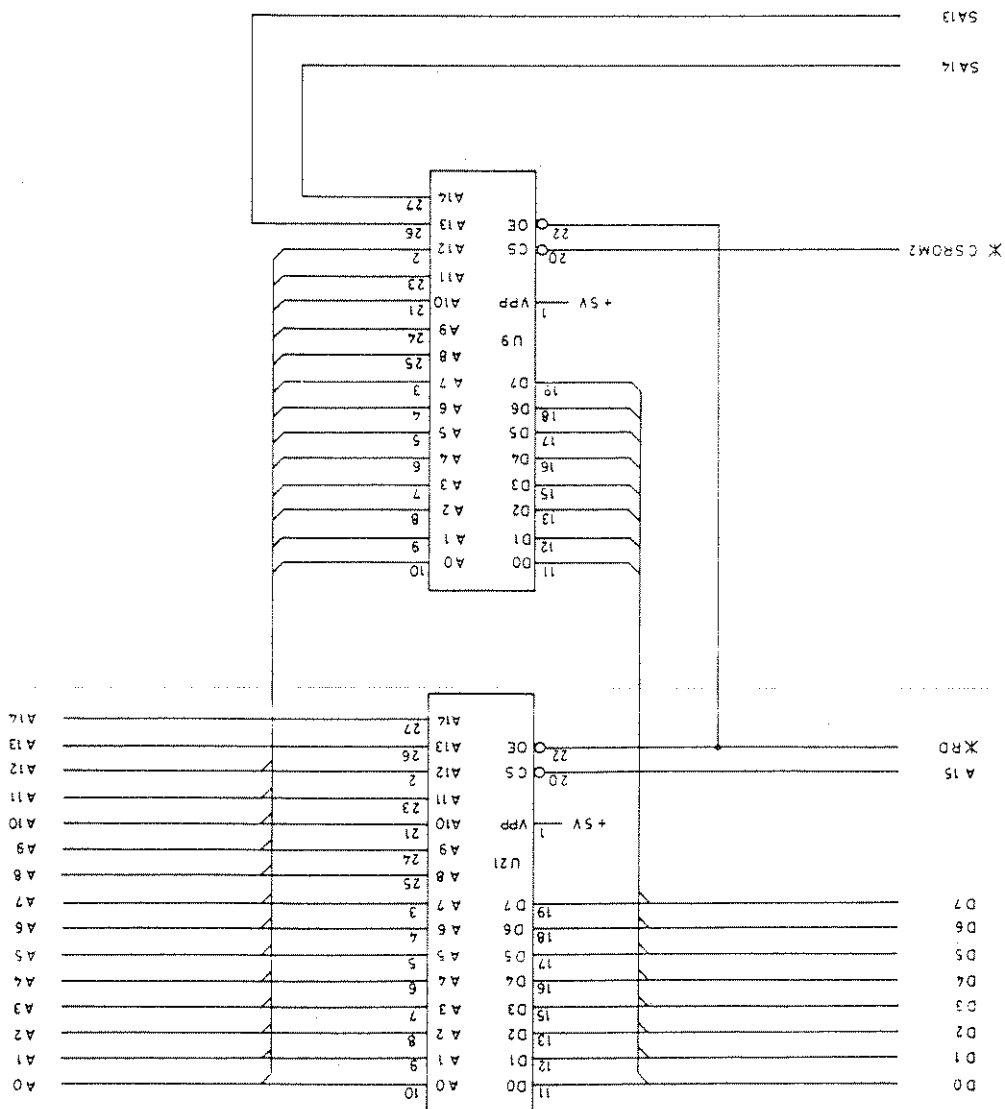

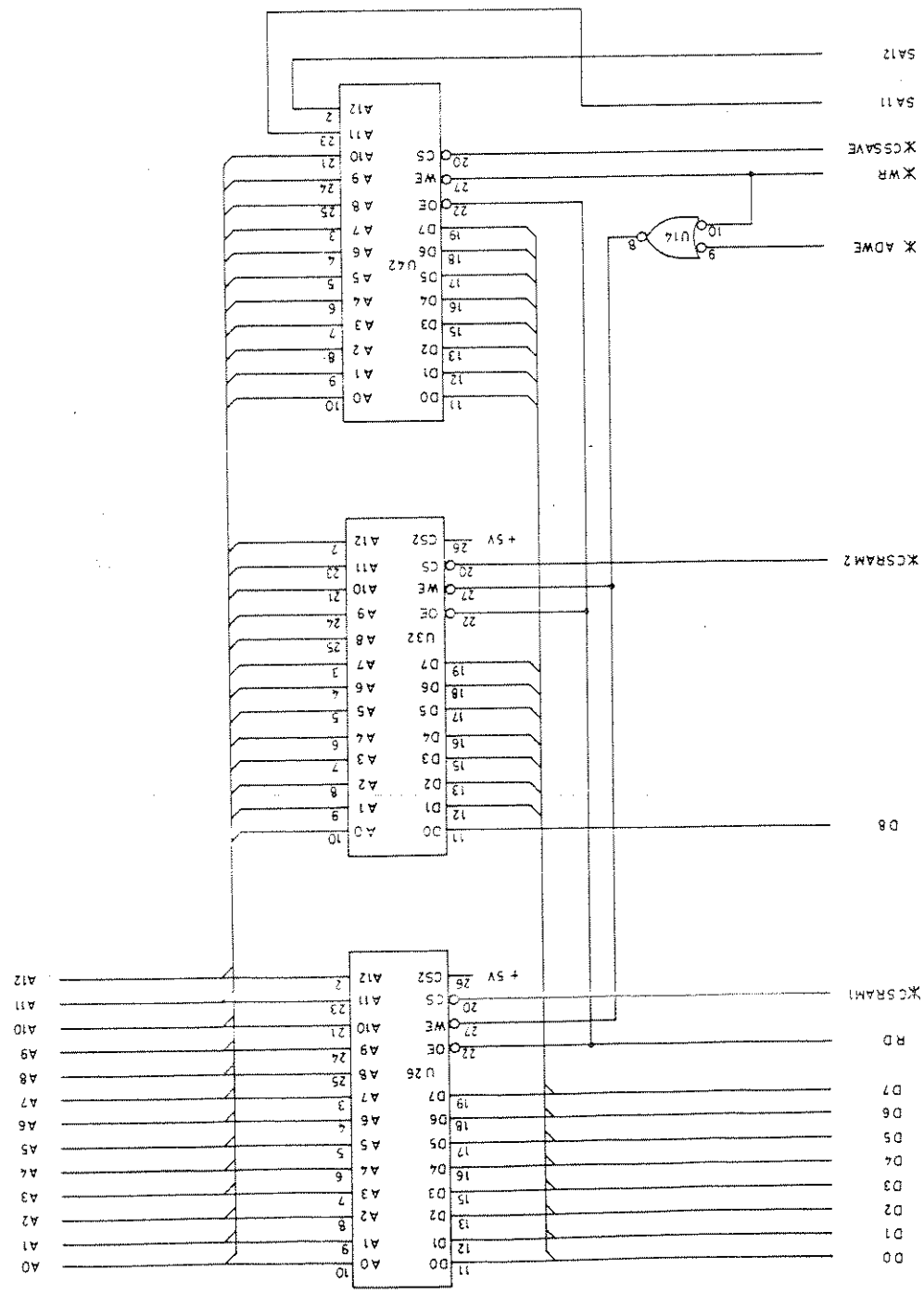

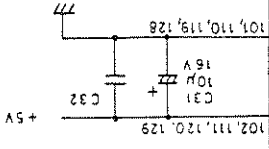

NORMAL 2
 X ANALOG 3
 X EXTBUS 54
 X ATT 97
 X LOCK 1
 95
 X GP1BC 40
 X GP1BA 39
 X CSAD 98
 X CRTC 115
 X CSLSI 87
 X LED2 67
 X LED1 108
 X CSXSCL 86
 X CSCNT 85
 X CSYSC 43
 X CSGRAM 116
 X CSSAVE 122
 X CSRAM2 123
 X CSRAM1 84
 X CSROM2 83
 X INT 99
 X BUSRD 107
 X WAIT 66
 SA11 82
 SA12 81
 SA13 118
 SA14 117

U23

14	A0	
13	A1	
12	A2	
11	A3	
10	A4	
9	A5	
8	A6	
7	A7	
6	A8	
5	A9	
4	A10	
55	A11	
56	A12	
57	A13	
58	A14	
59	A15	
16	X MREQ	
65	X RD	
106	X WR	
100	X BR	
133	X M1	
17	X IOR0	
109	X RESET	
76	X INTGP1B	
114	X INTRAMP	+5V R26
112	X INTRAMP	TG
124	X INTRAMP	
52	X ADCS	
53	X ADWE	

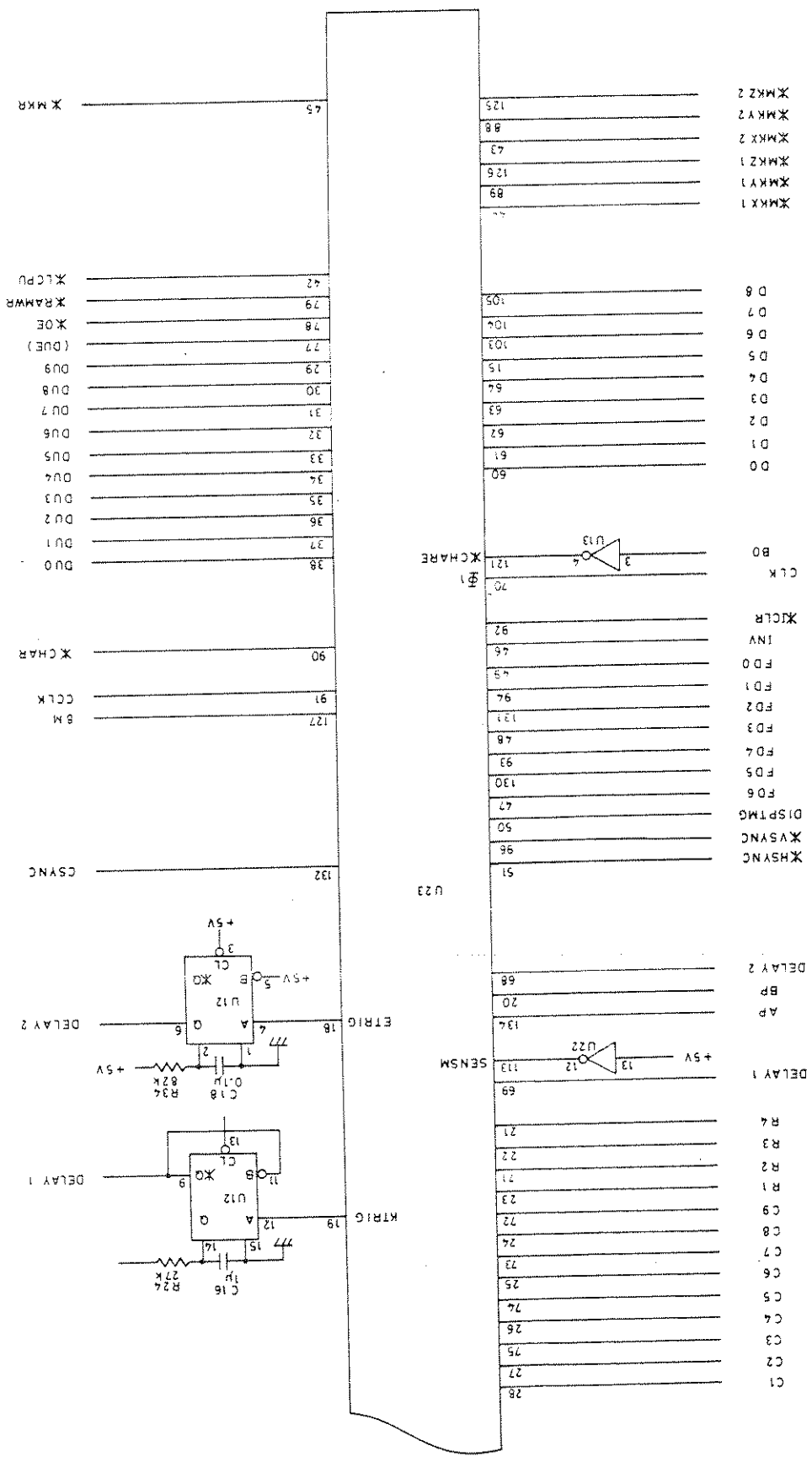

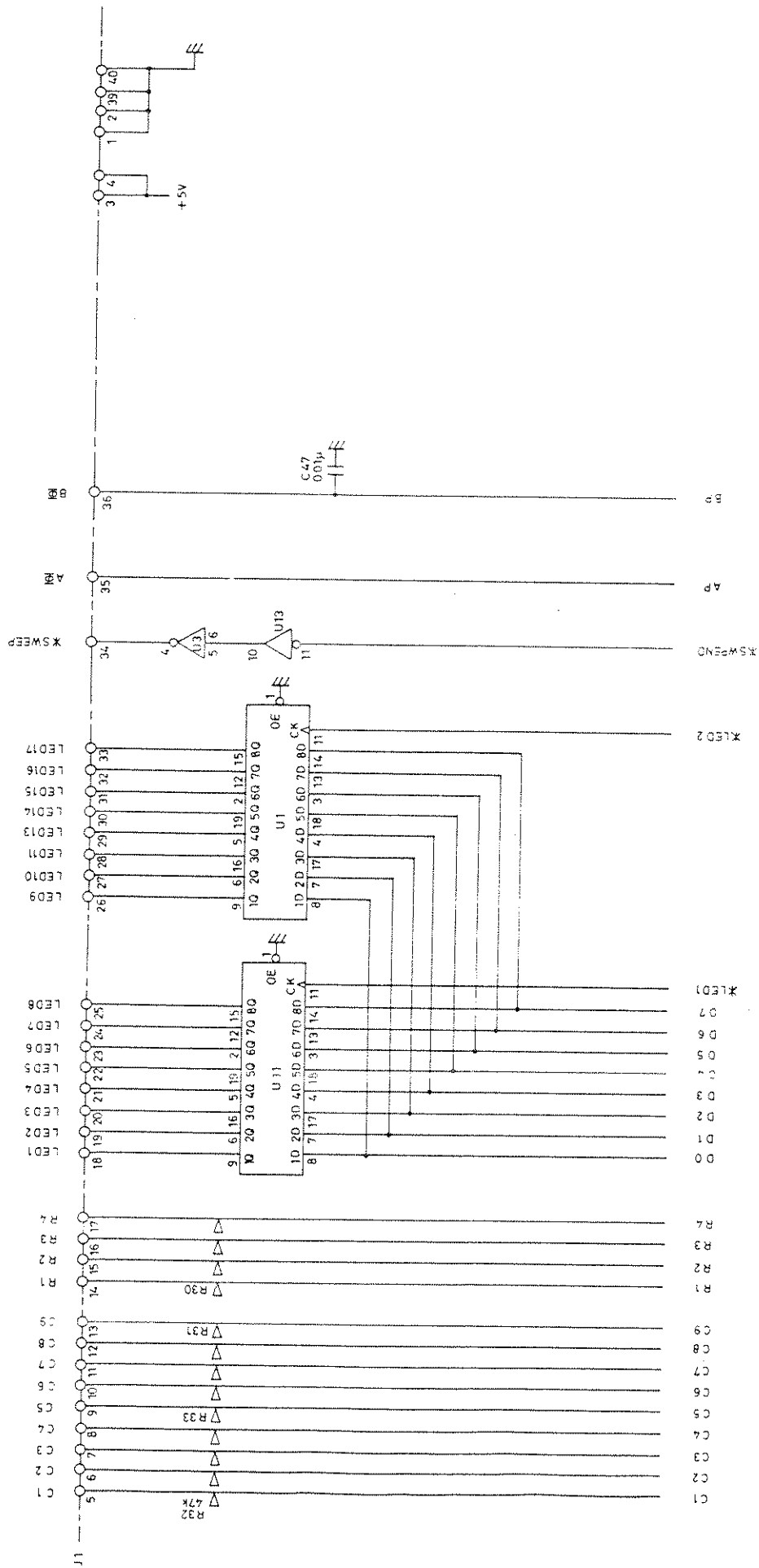

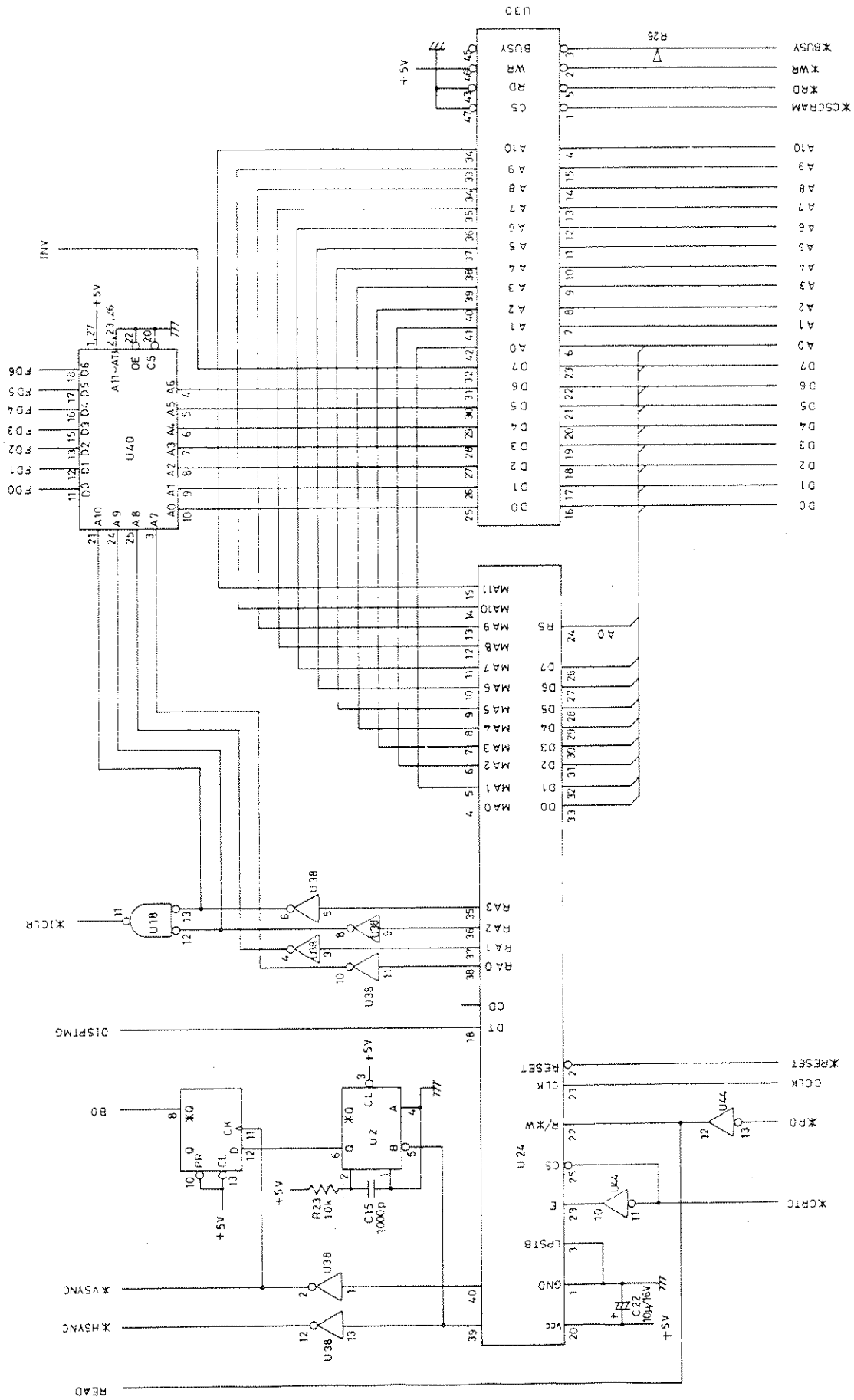

R4131 SERIES
 LOGIC
 BLR-015114 7/14
 A - 45

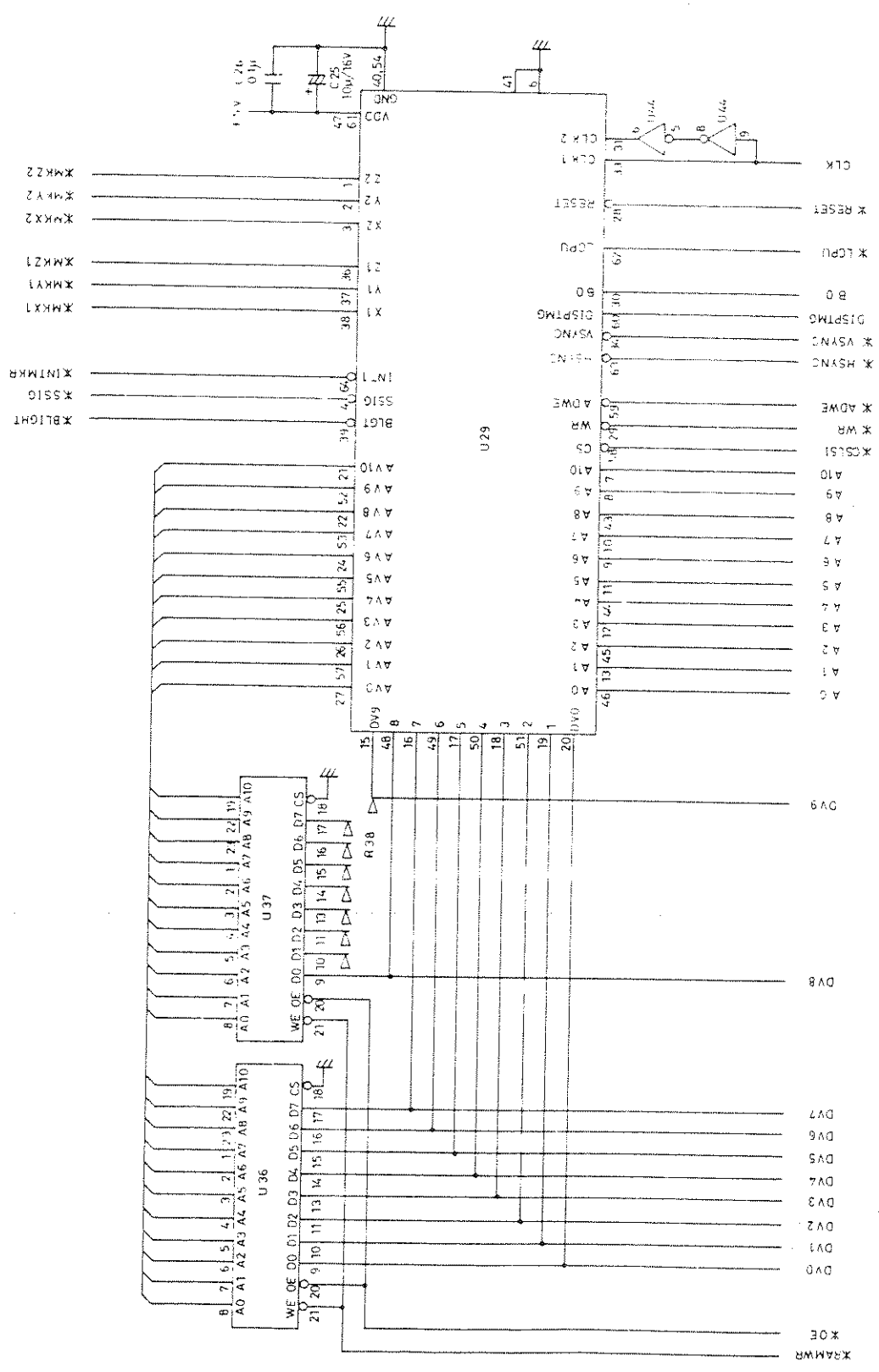

R4131 SERIES
LOGIC
BLR-015114 1/14

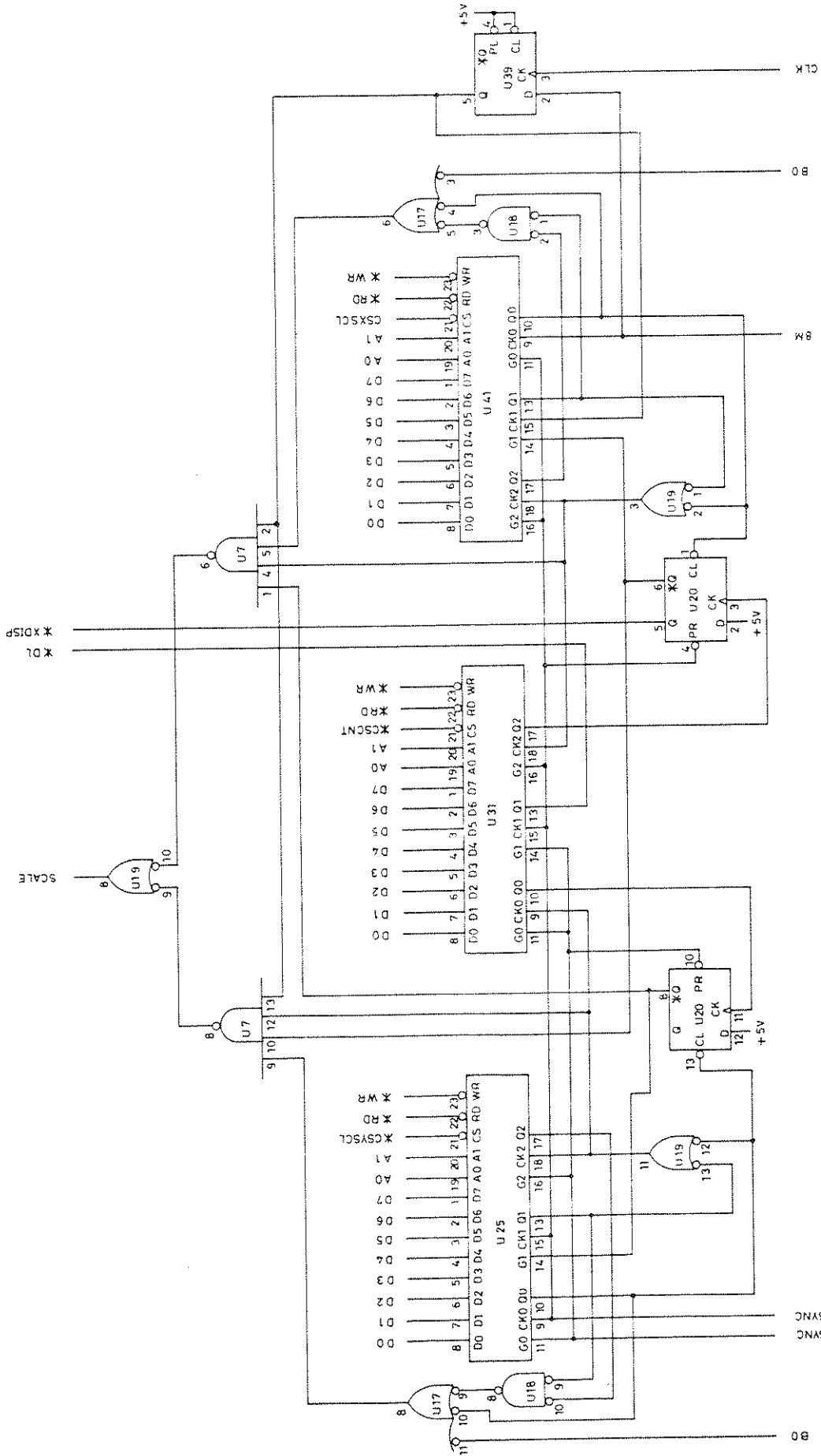

R4131 SERIES
 LOGIC
 BLR-015114 9/14
 A - 47

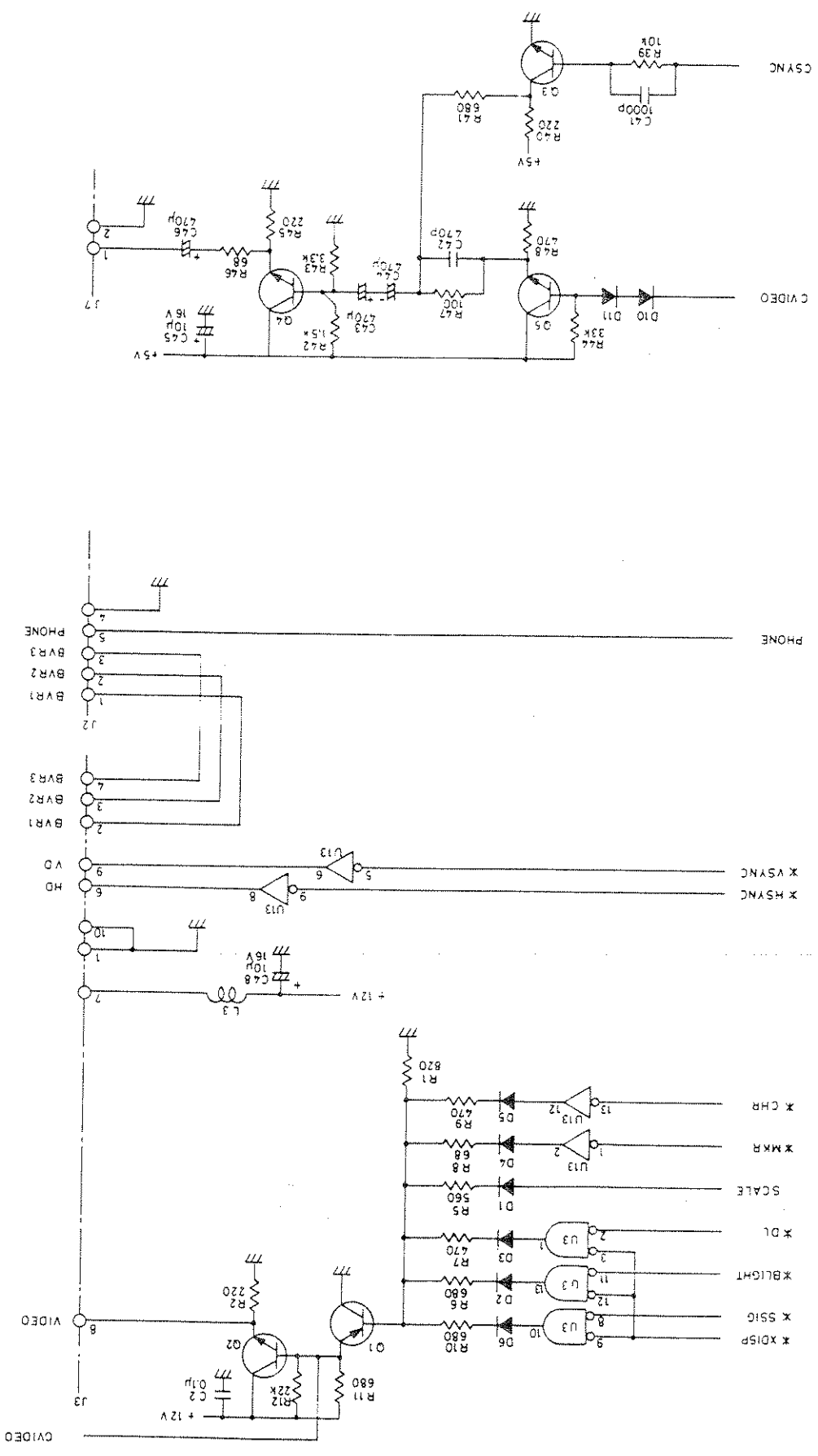

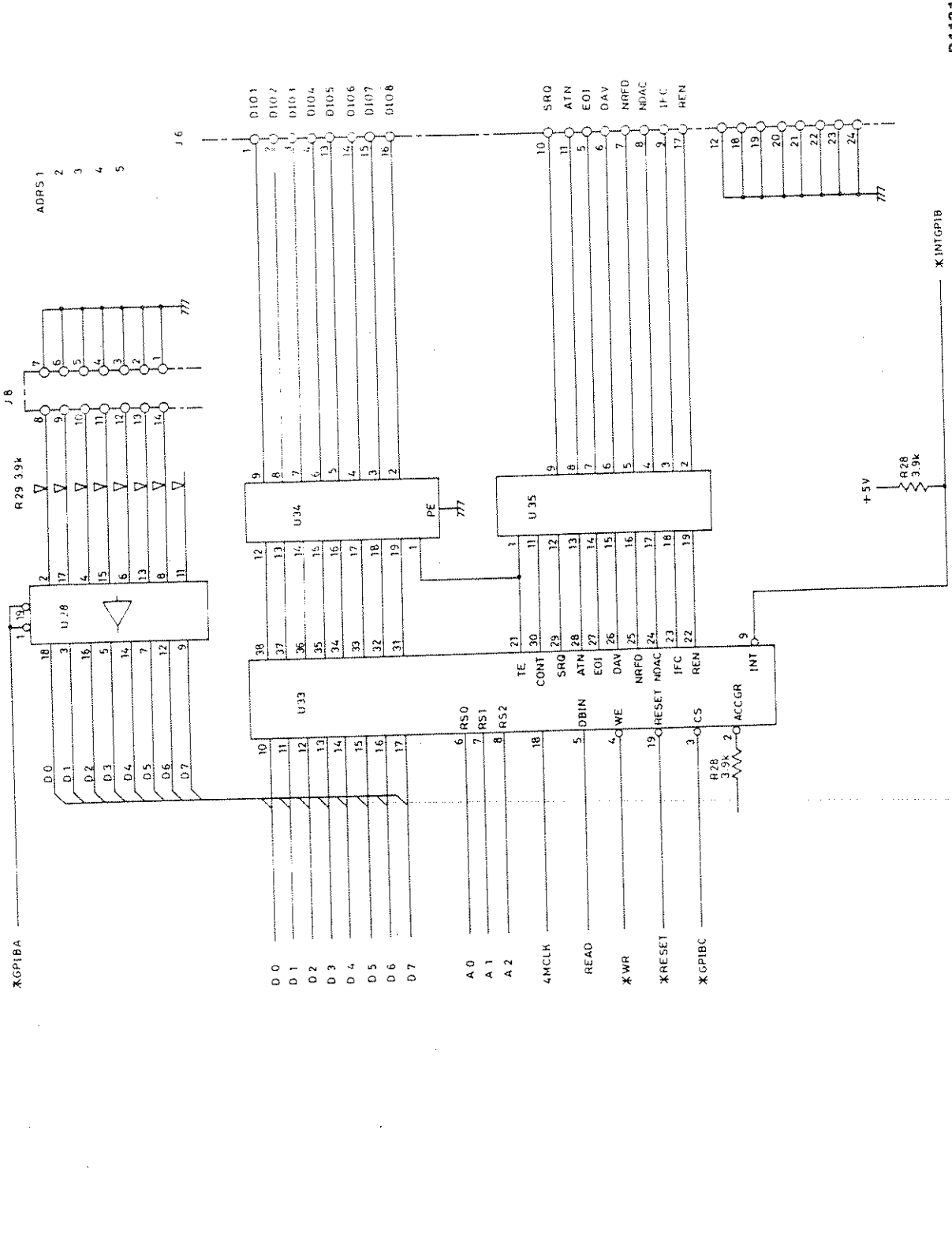

R4131 SERIES
 LOGIC
 BLR-015114 11/14
 A - 49

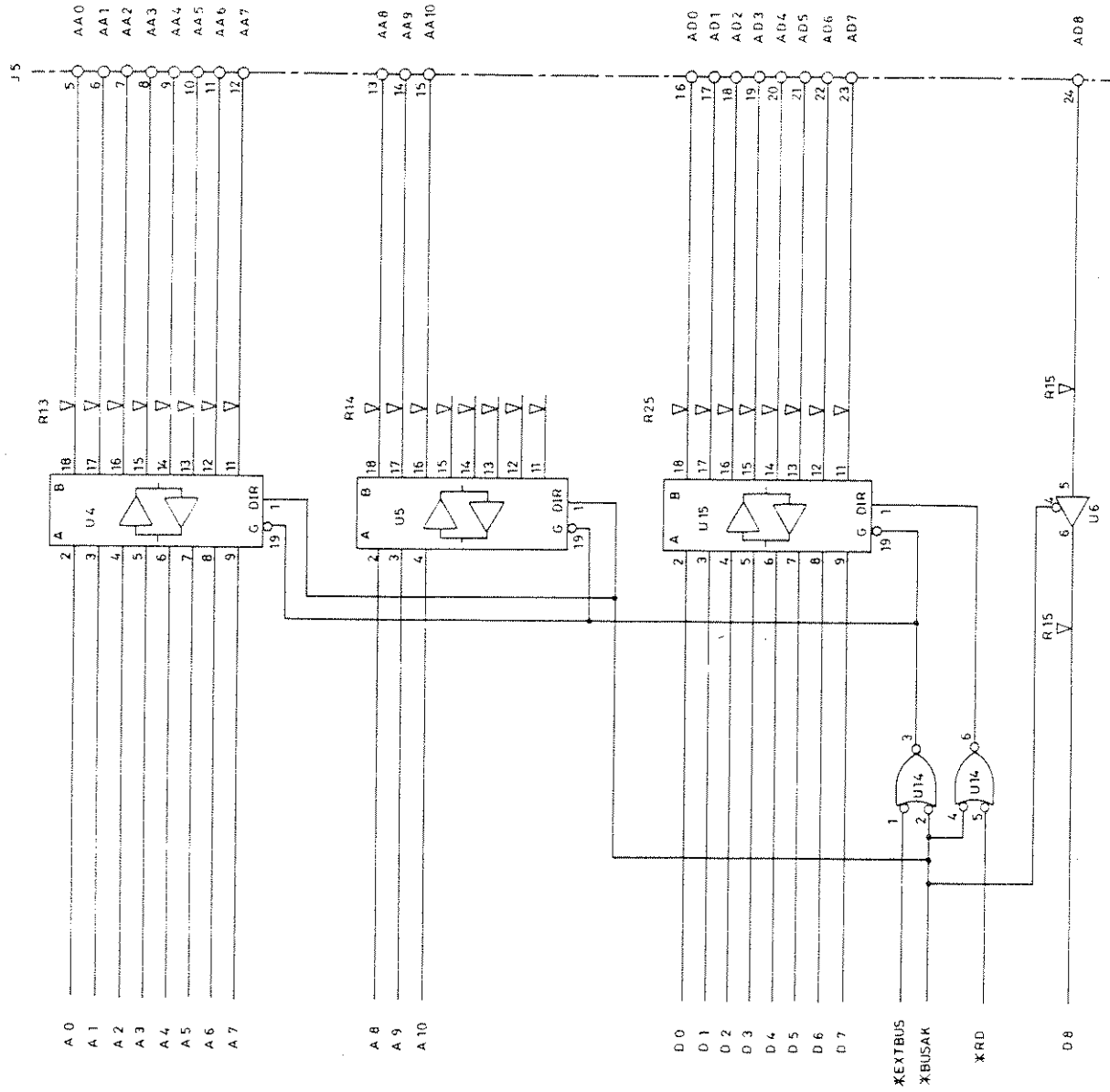

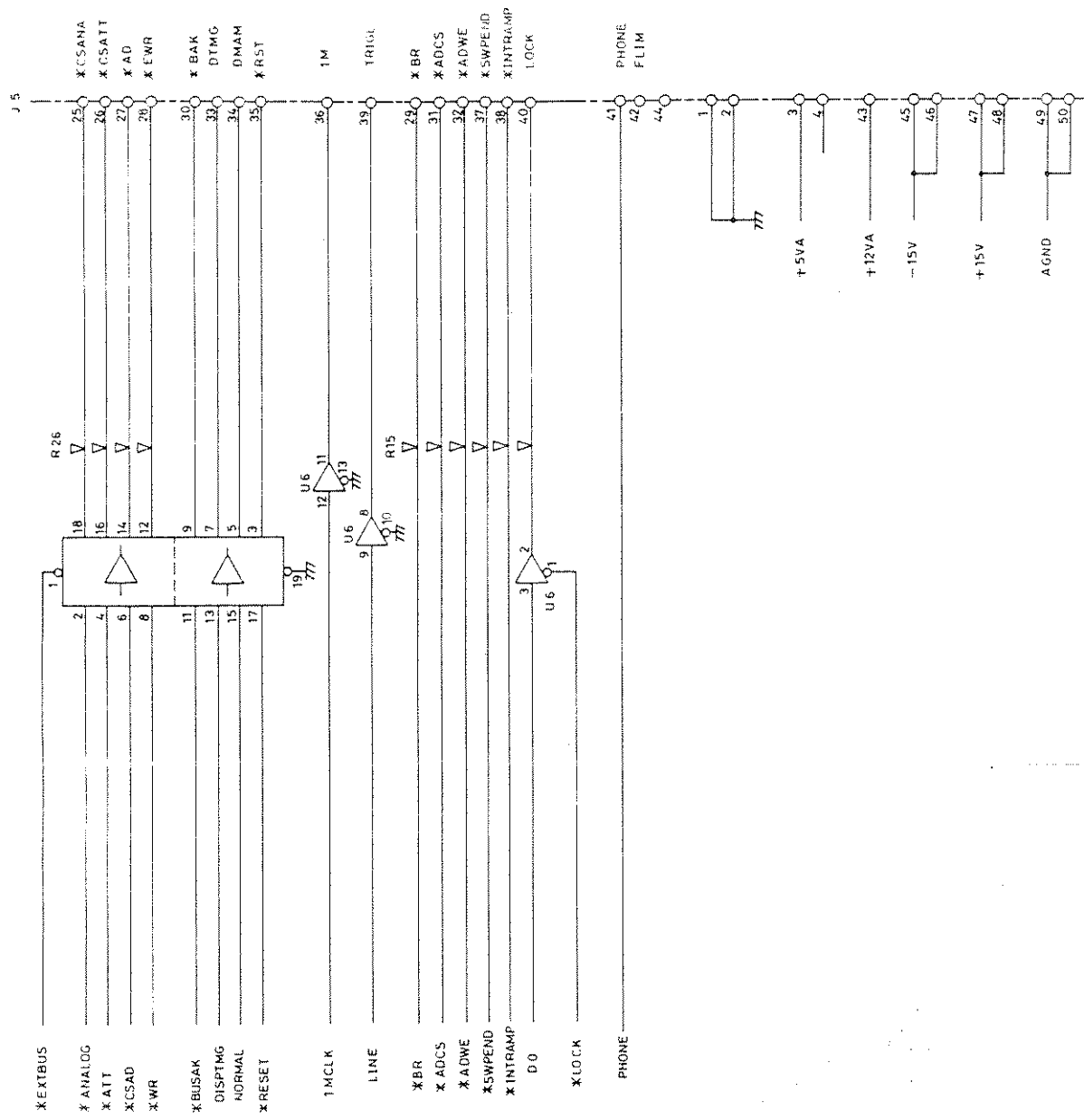

R4131 SERIES
 LOGIC
 BLR-015114 13/14
 A - 51

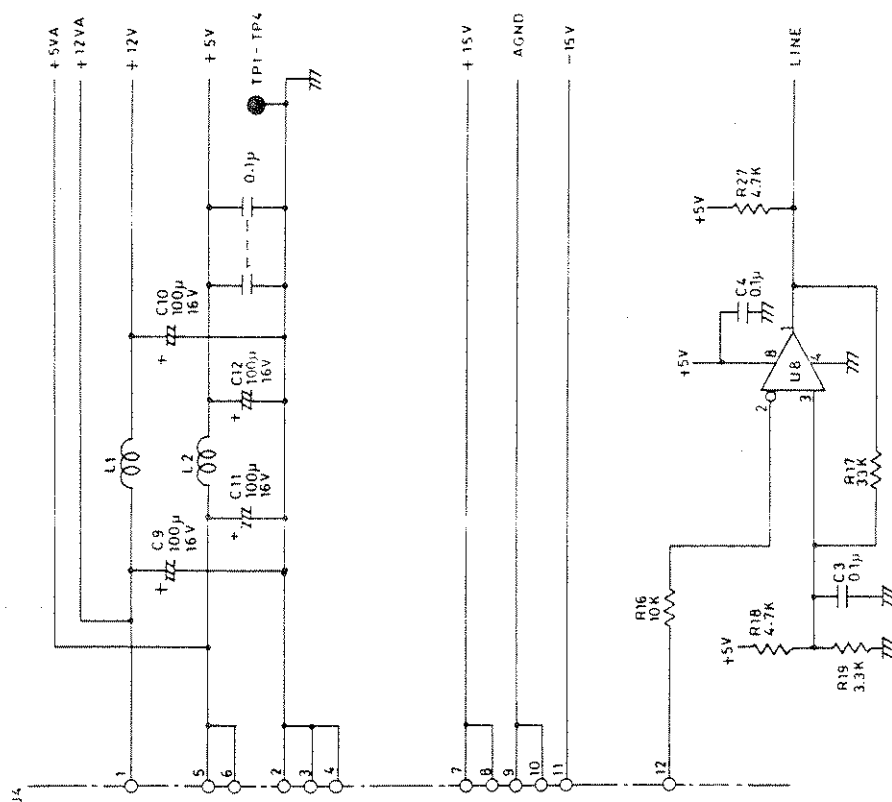

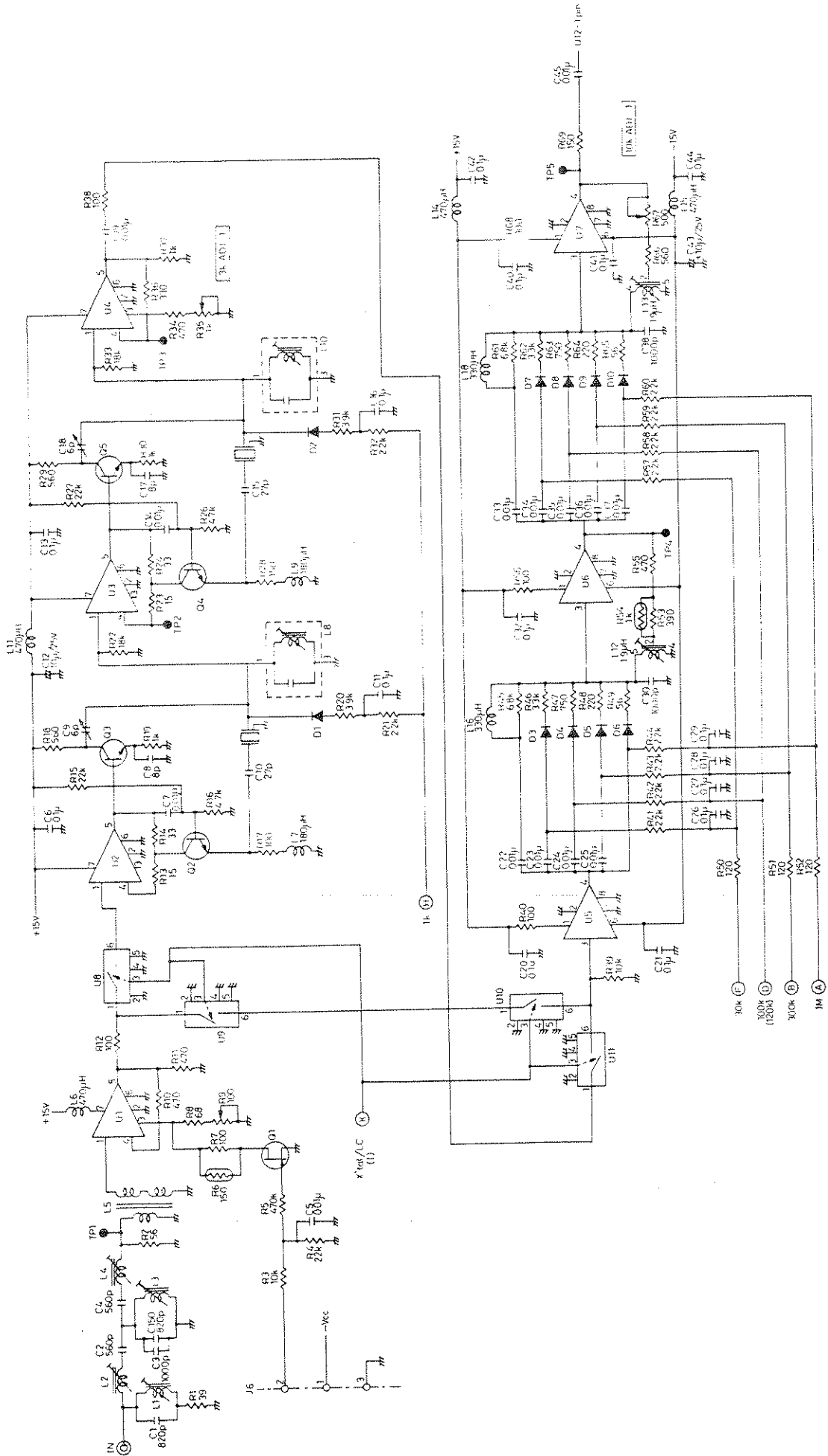

R4131 SERIES
YTO CNT/IF
BLR-015116 1/6

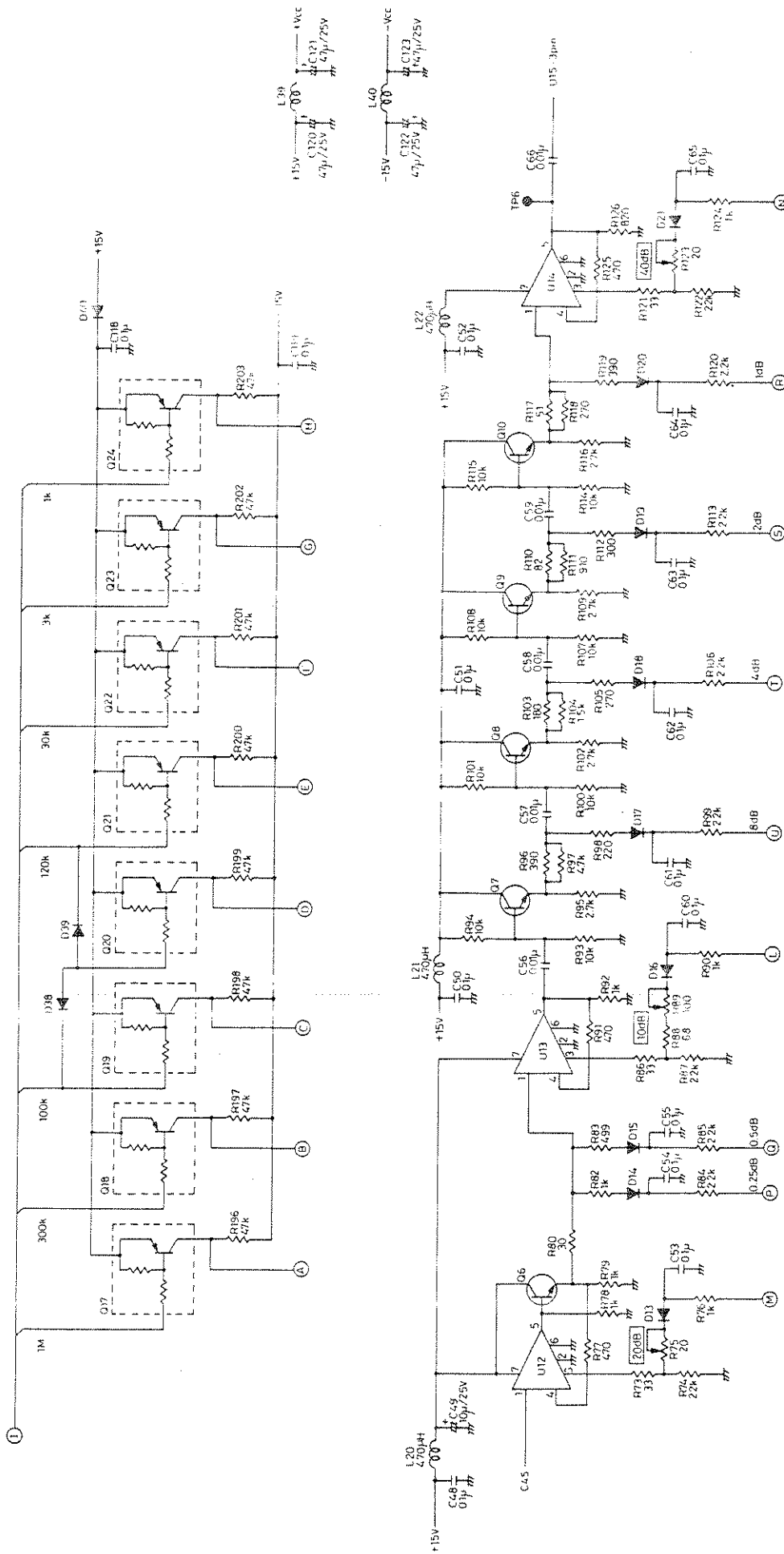

R4131 SERIES
 YTO CNT/IF
 BLR-015116 2/6
 A - 54

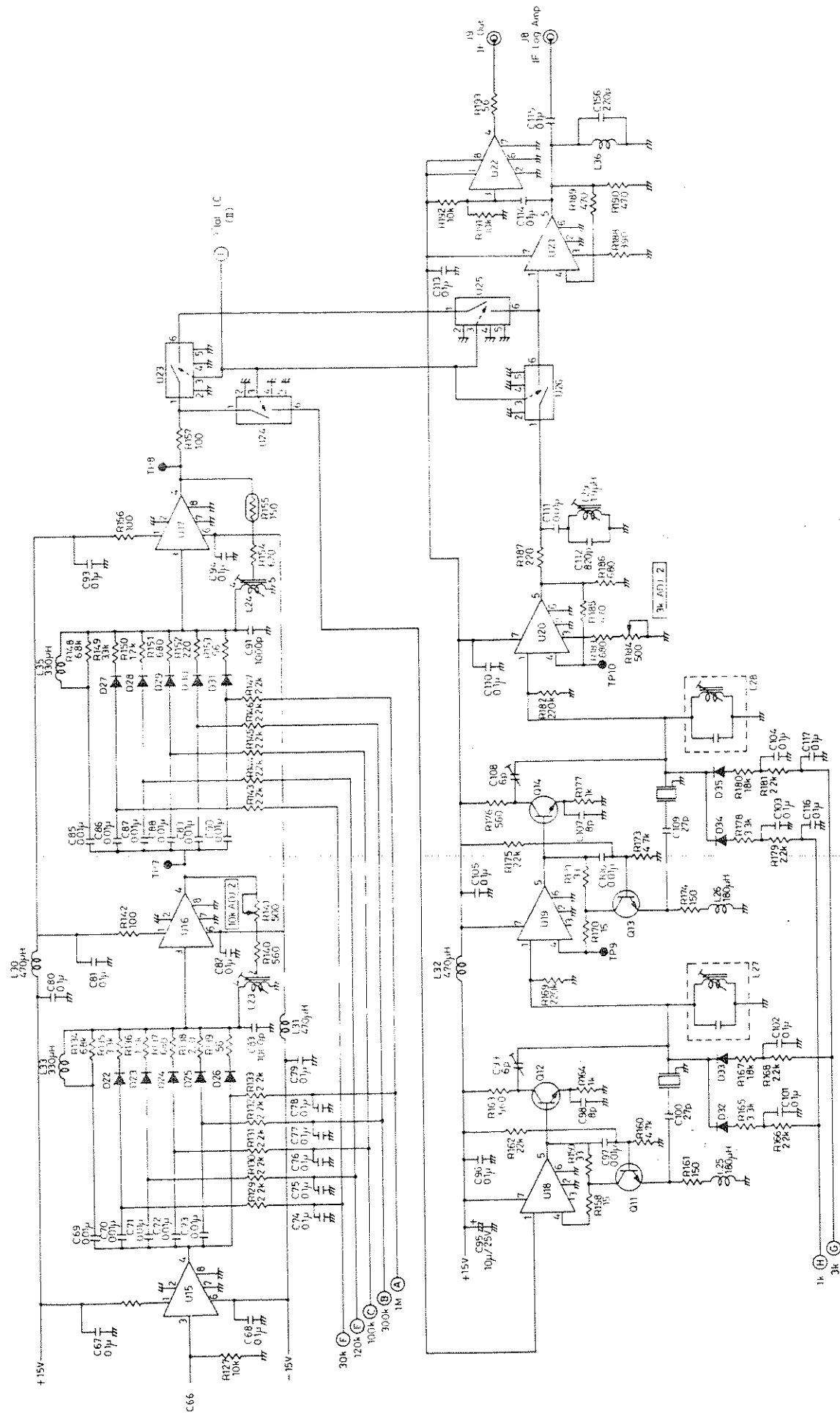

R4131 SERIES
 YTO CNT/IF
 BLR-015116 3/6
 A - 55

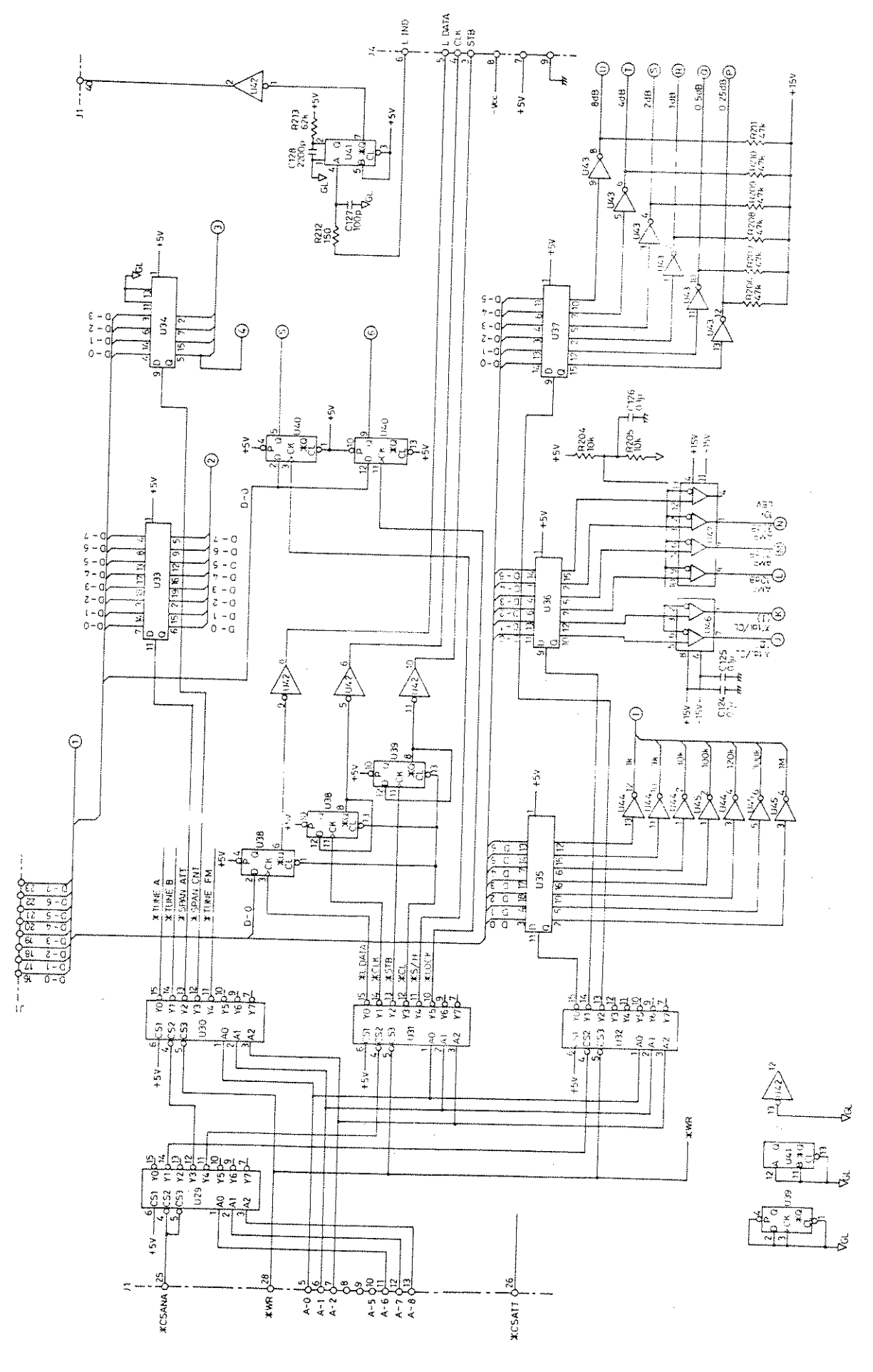

R4131A/C
 YTO CNT/IF
 BLR-015116 4/6
 A-55

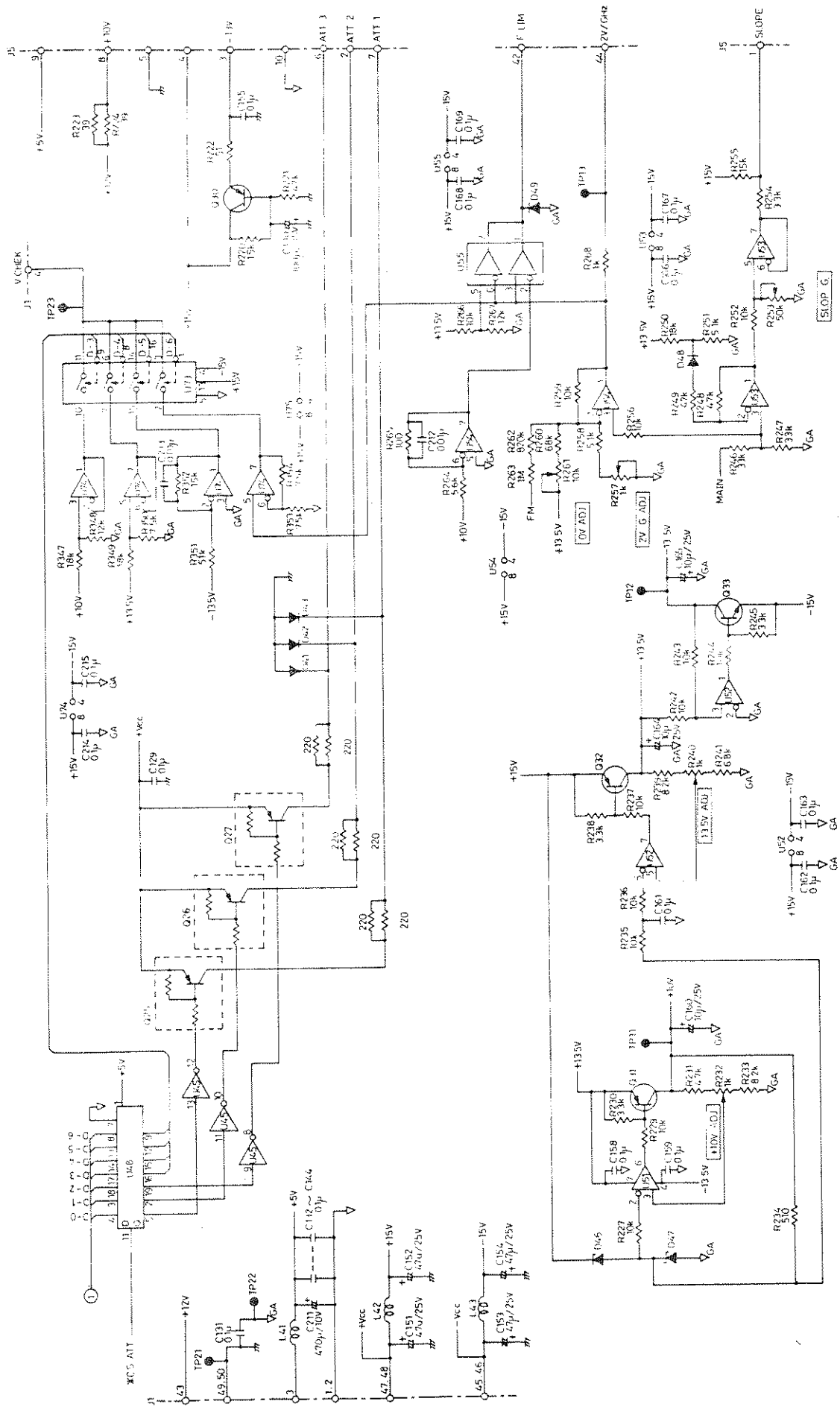

R4131 SERIES
 YTO CNT/IF
 BLR-015116 5/6
 A - 57

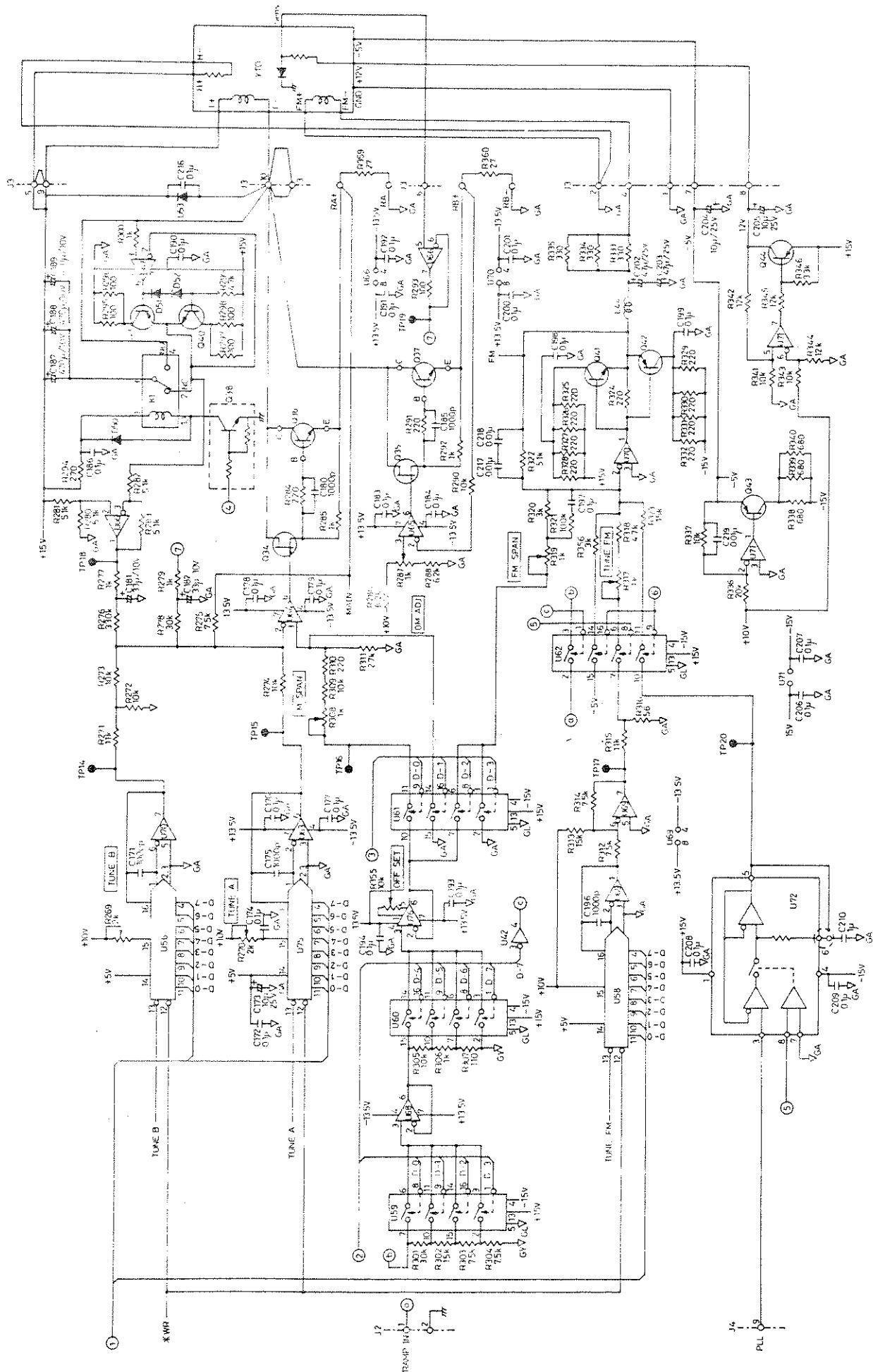

R4131 SERIES
VTO CNT/IF
BLR-015116 6/6
 A - 58

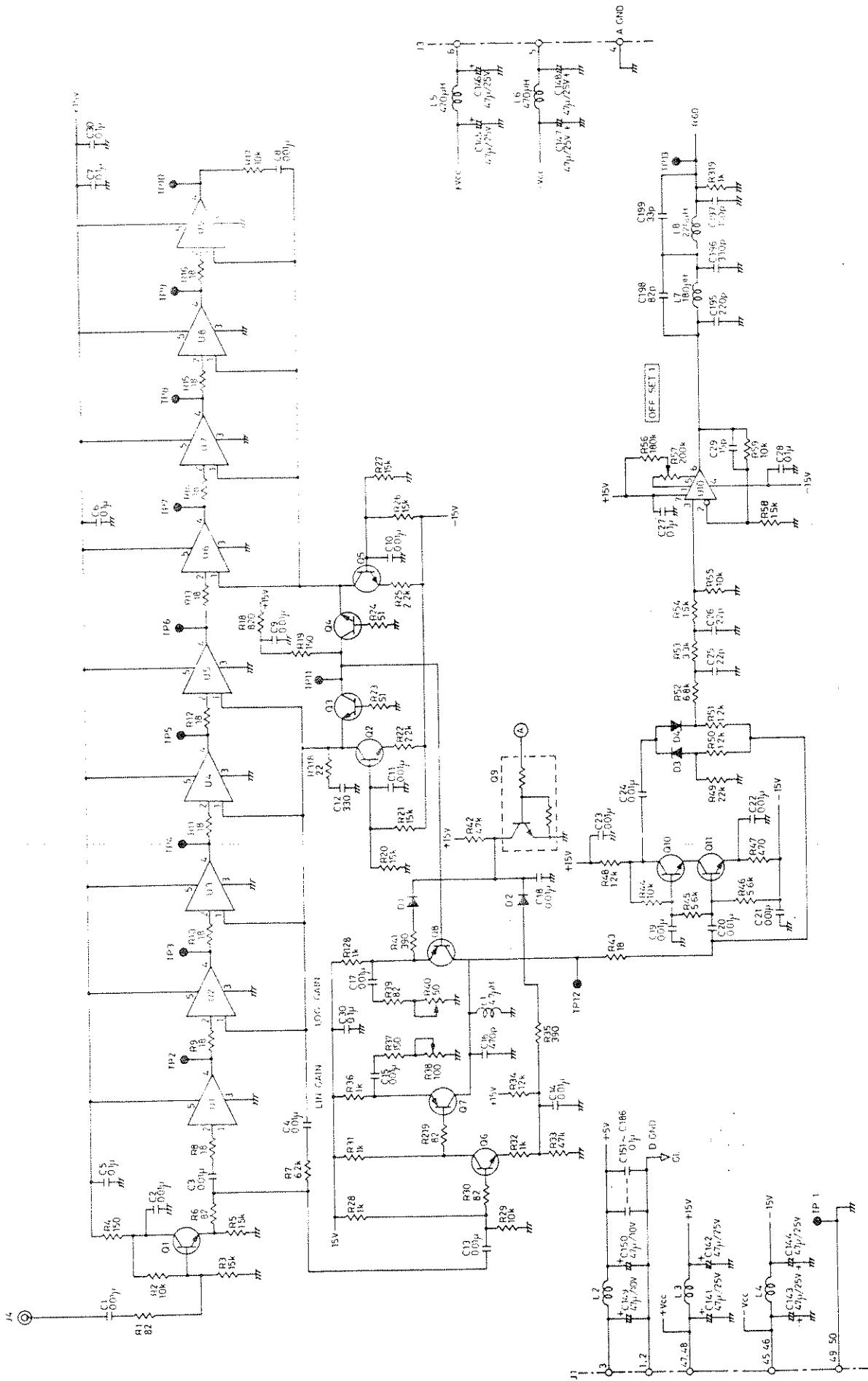

R4131 SERIES
ANALOG(Lo9)
BLR-015117 1/8
 A - 59

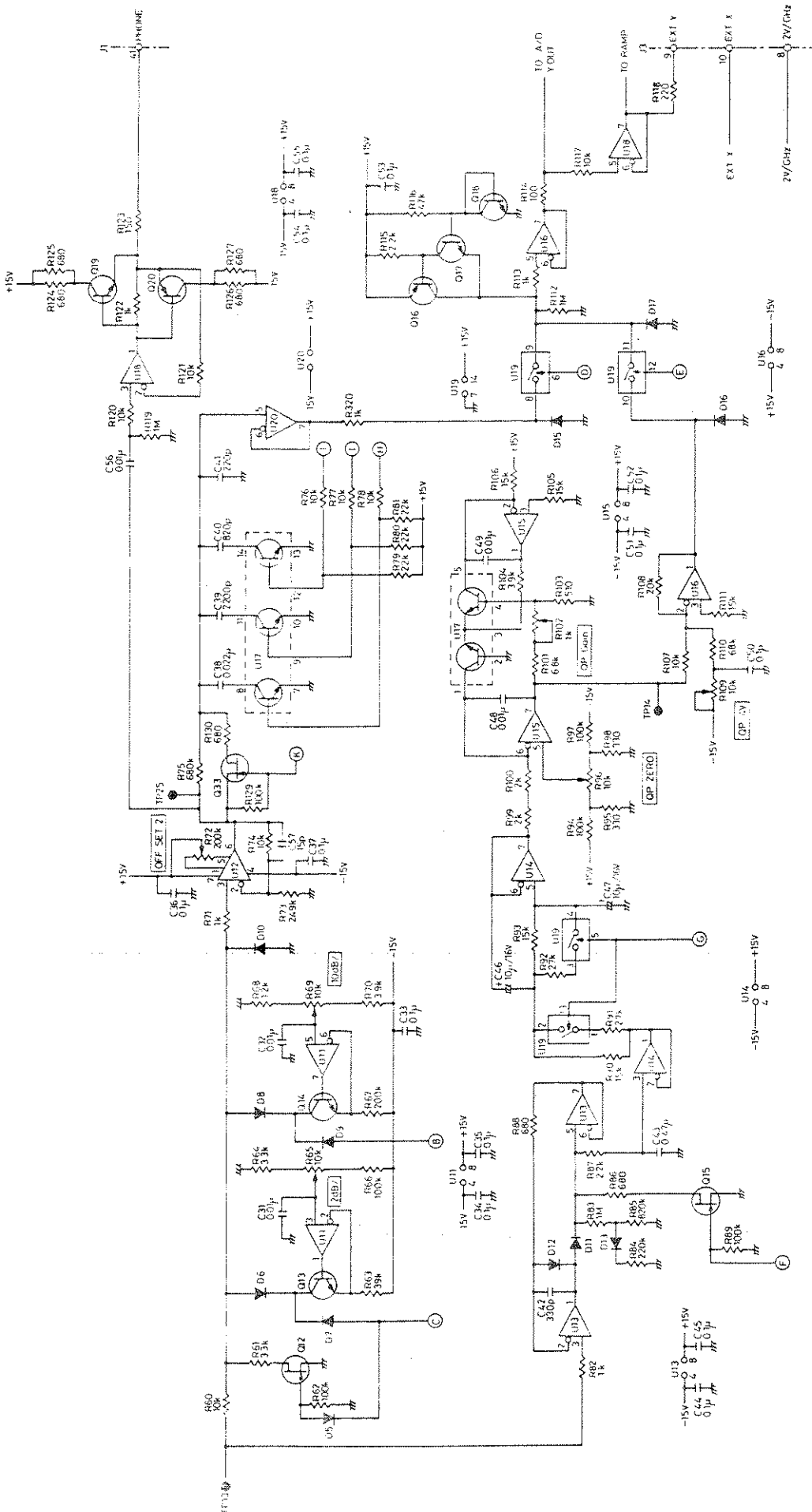

R4131 SERIES
ANALOG(L09)
BLR-015117 2/8
 A - 60

**R4131 SERIES
ANALOG (Ramp)
BLR-015117 3/8**
A - 61

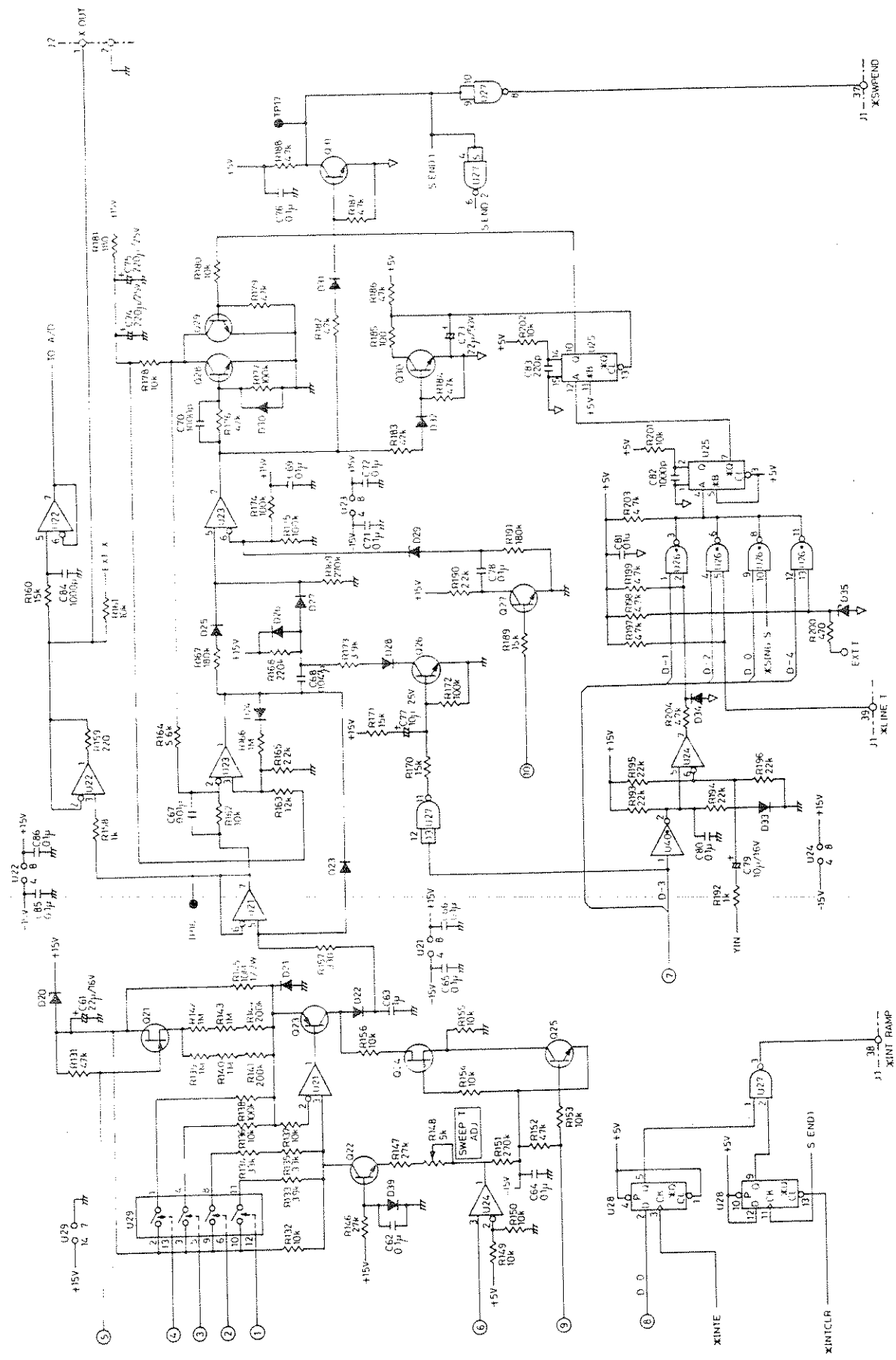

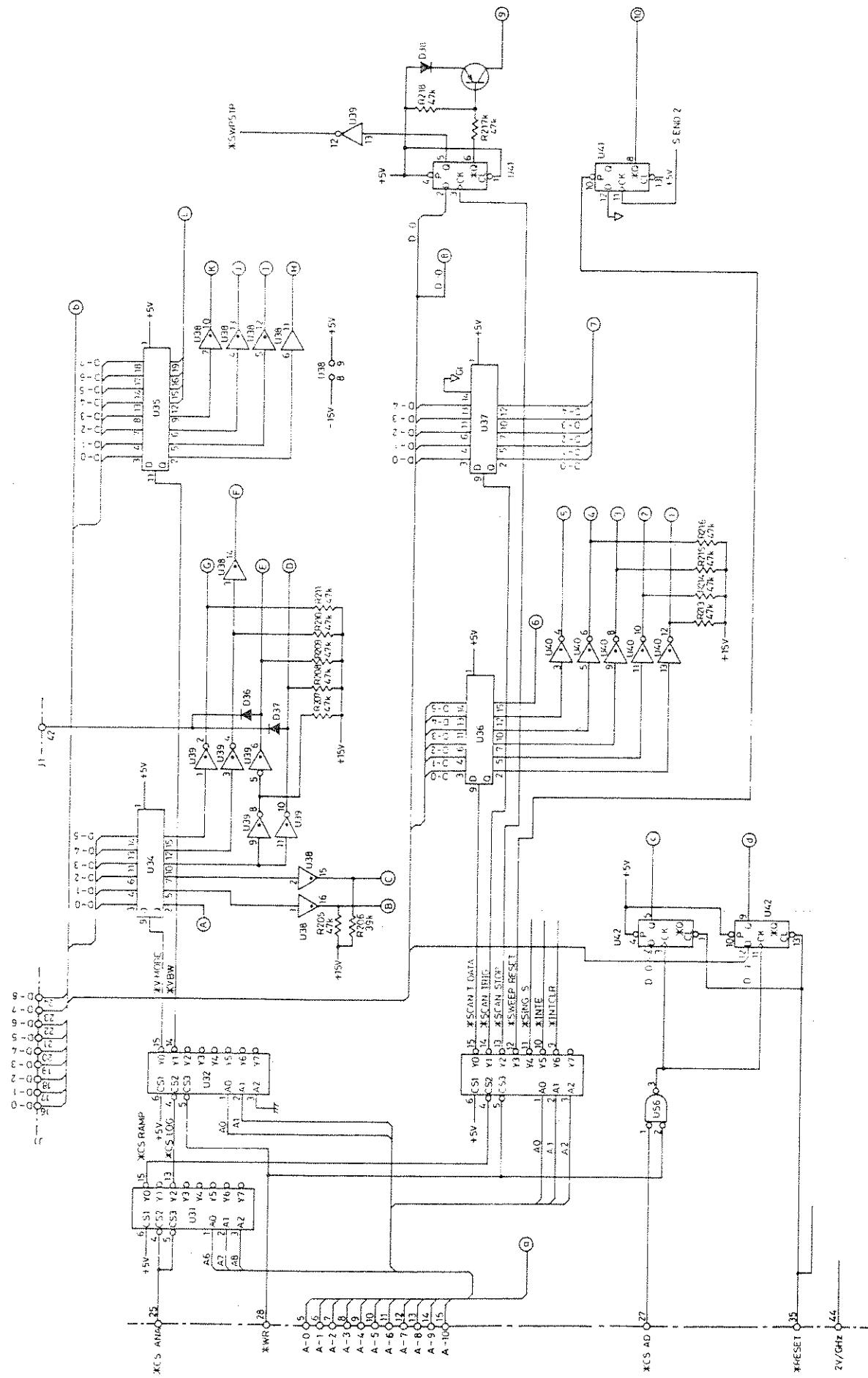

R4131 SERIES
 ANALOG
 BLR-015117 4/8
 A - 62

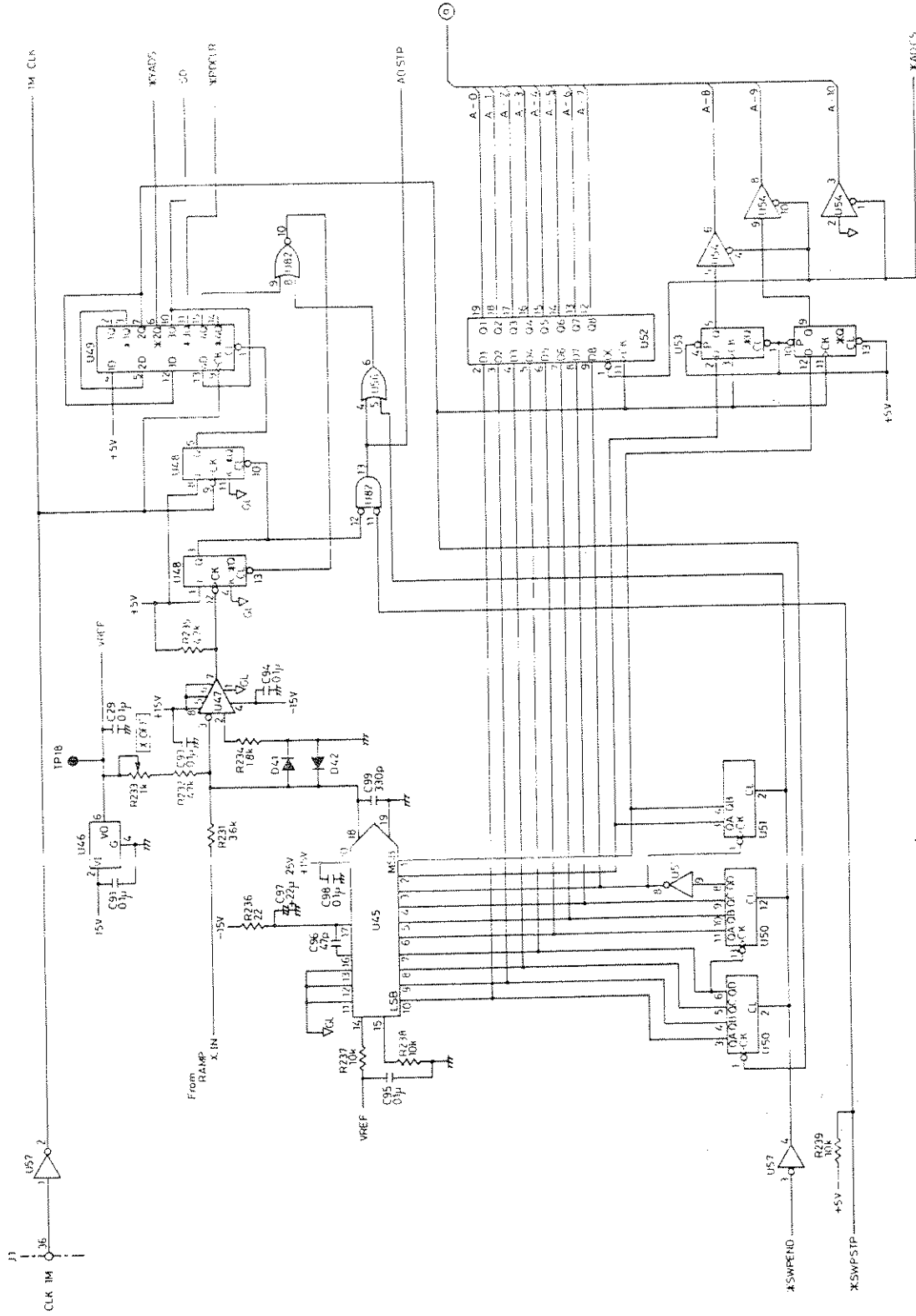

R4131 SERIES
 ANALOG (A/D)
 BLR-015117 5/8
 A - 63

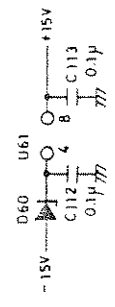
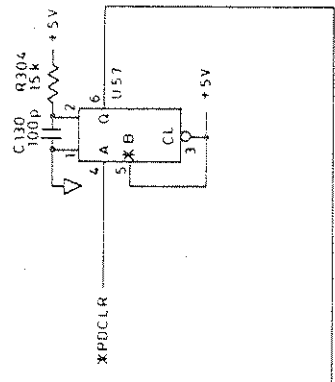
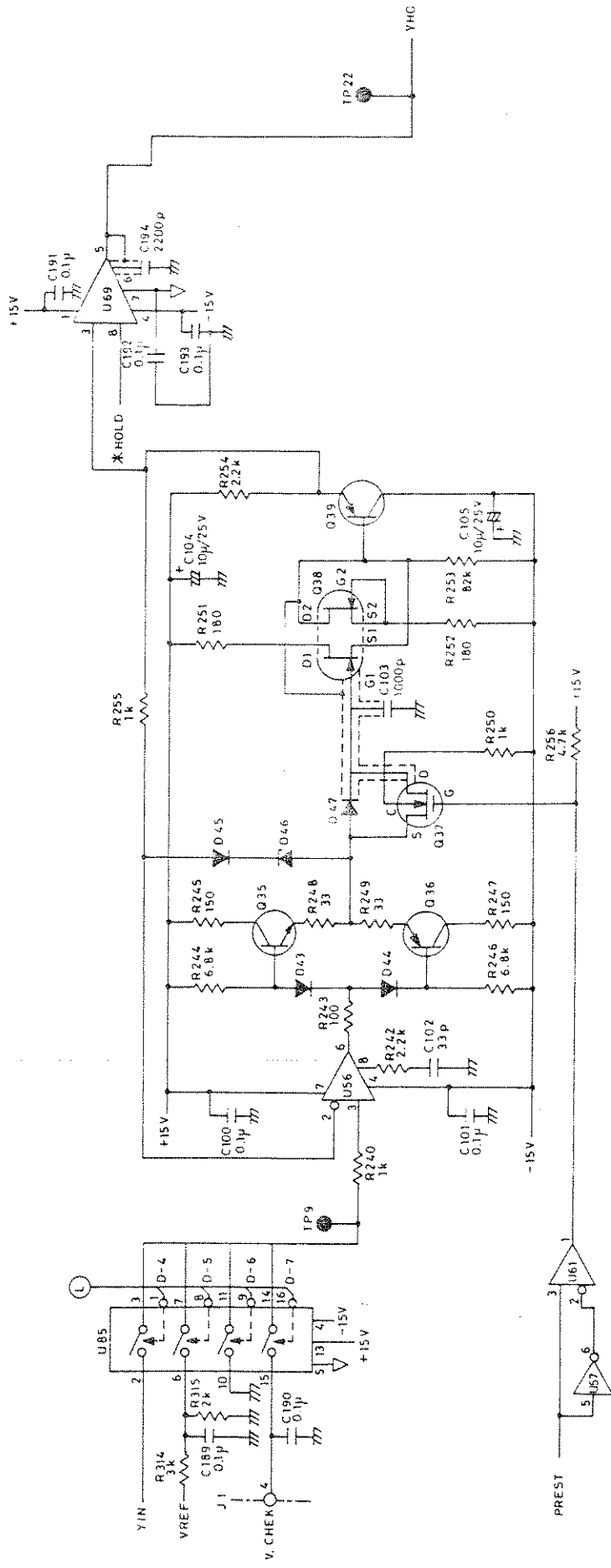

R4131A/AN/C/CN
 ANALOG (A/D)
 BLR-015117 6/8
 A - 64

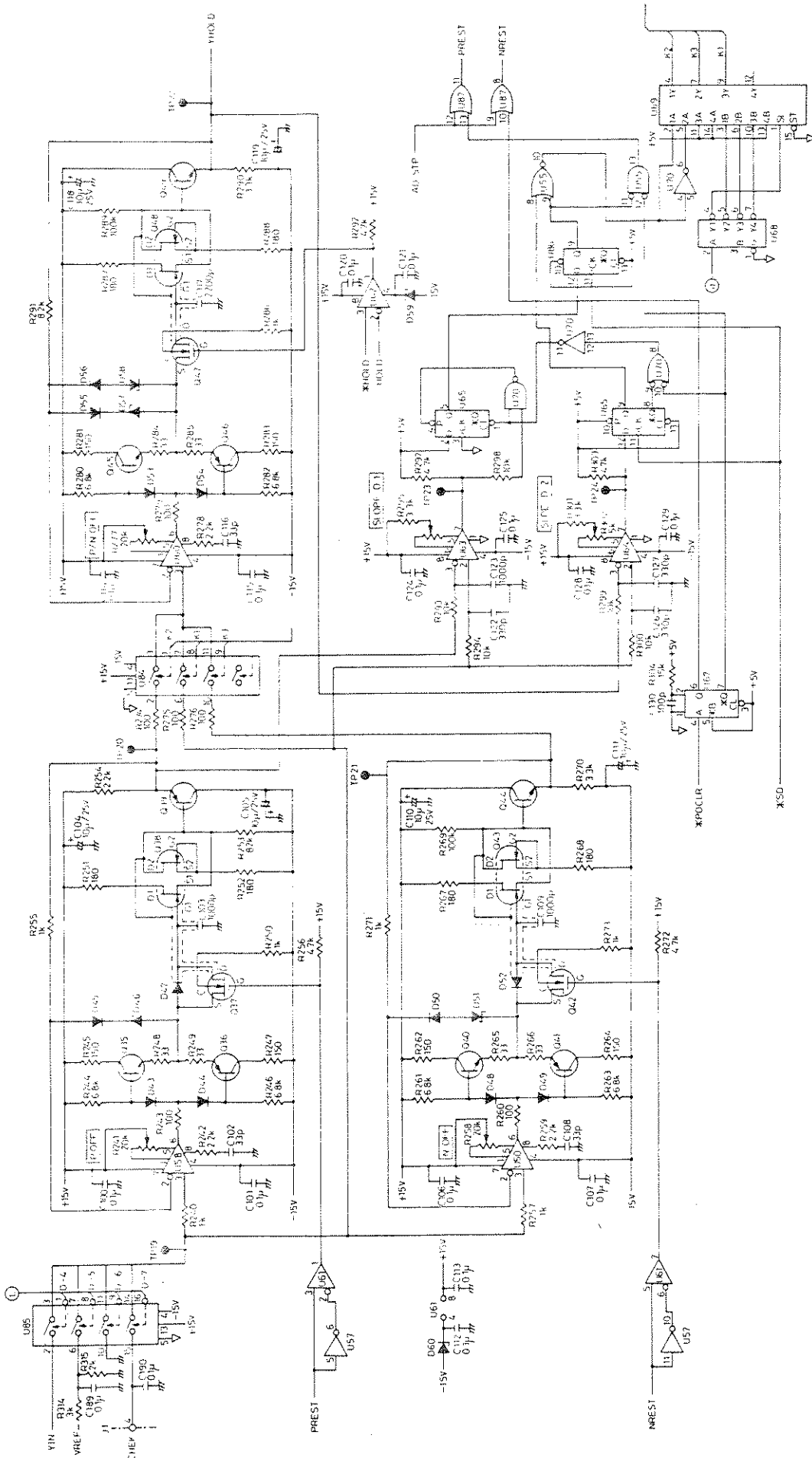

R4131B/BN/D/DN
 ANALOG(A/D)
 BLR-015117 7/8
 A - 65

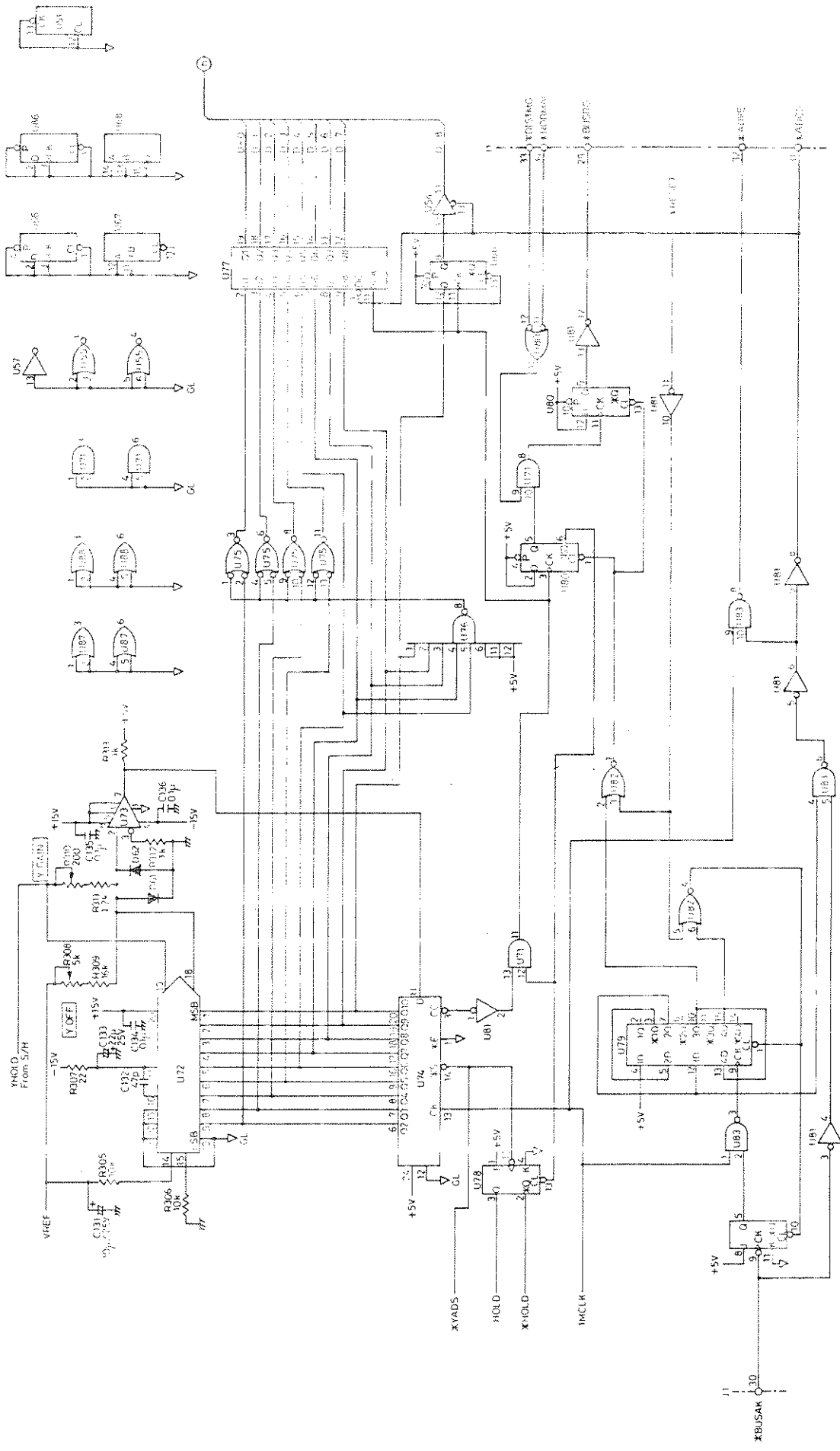

R4131 SERIES
ANALOG (A/D)
BLR-015117 U/8
 A - 66

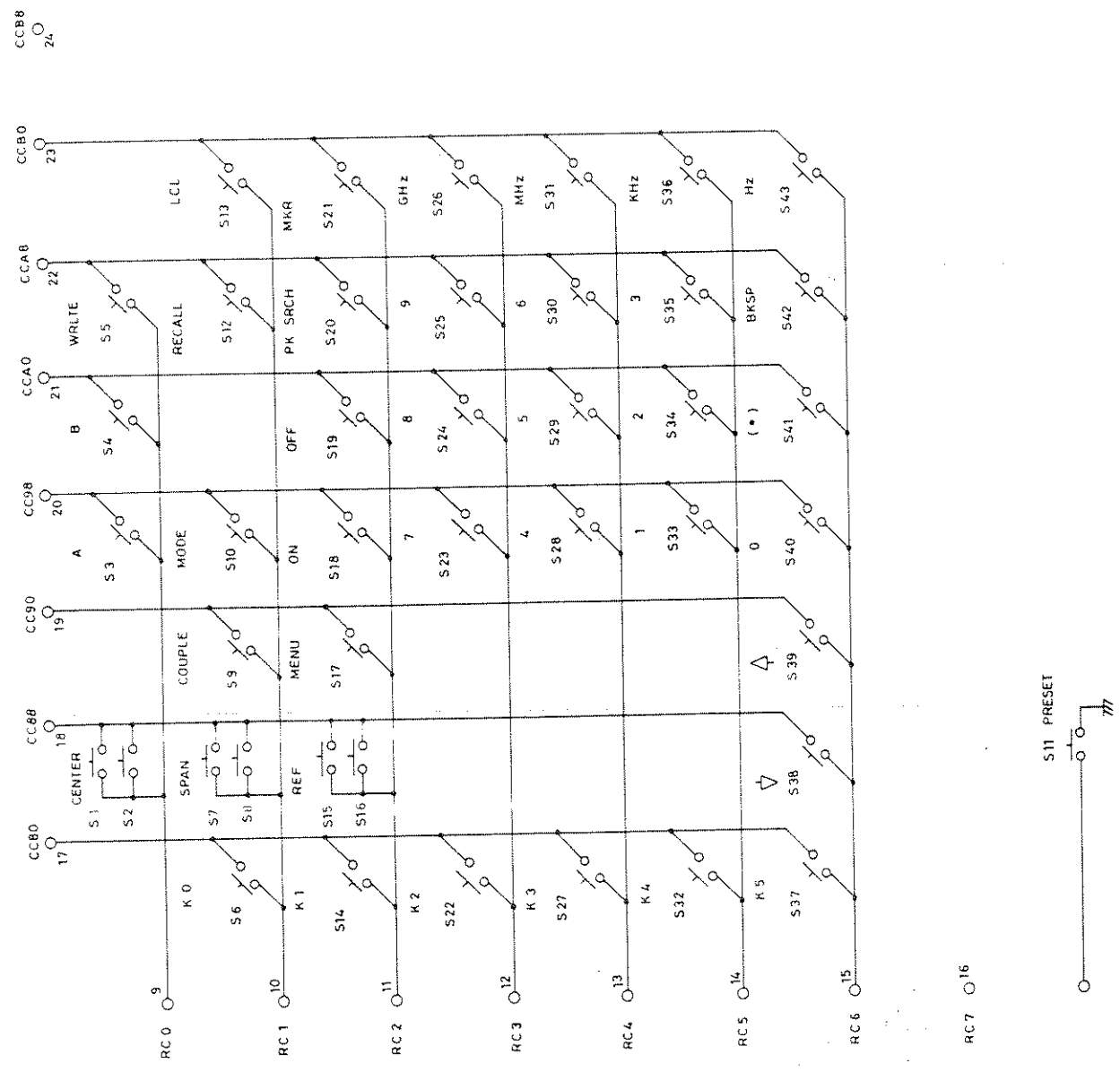

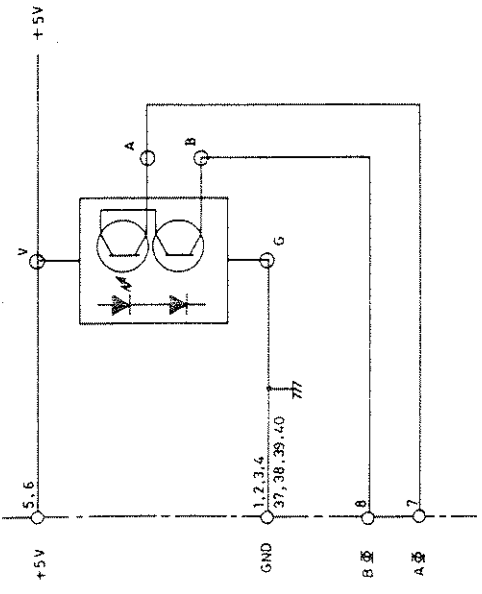
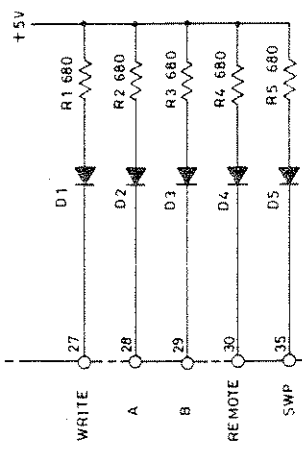
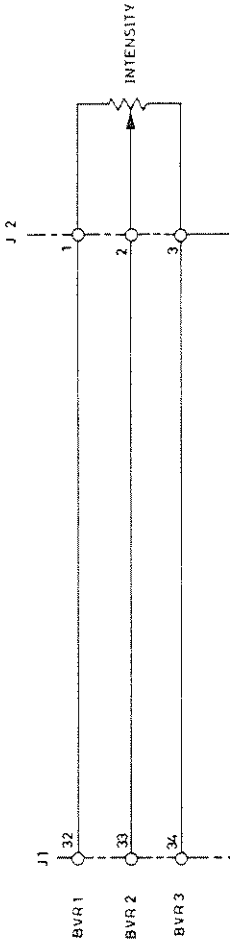

R4131 SERIES
 KEY
 BLC-015115 2/2
 A - 68

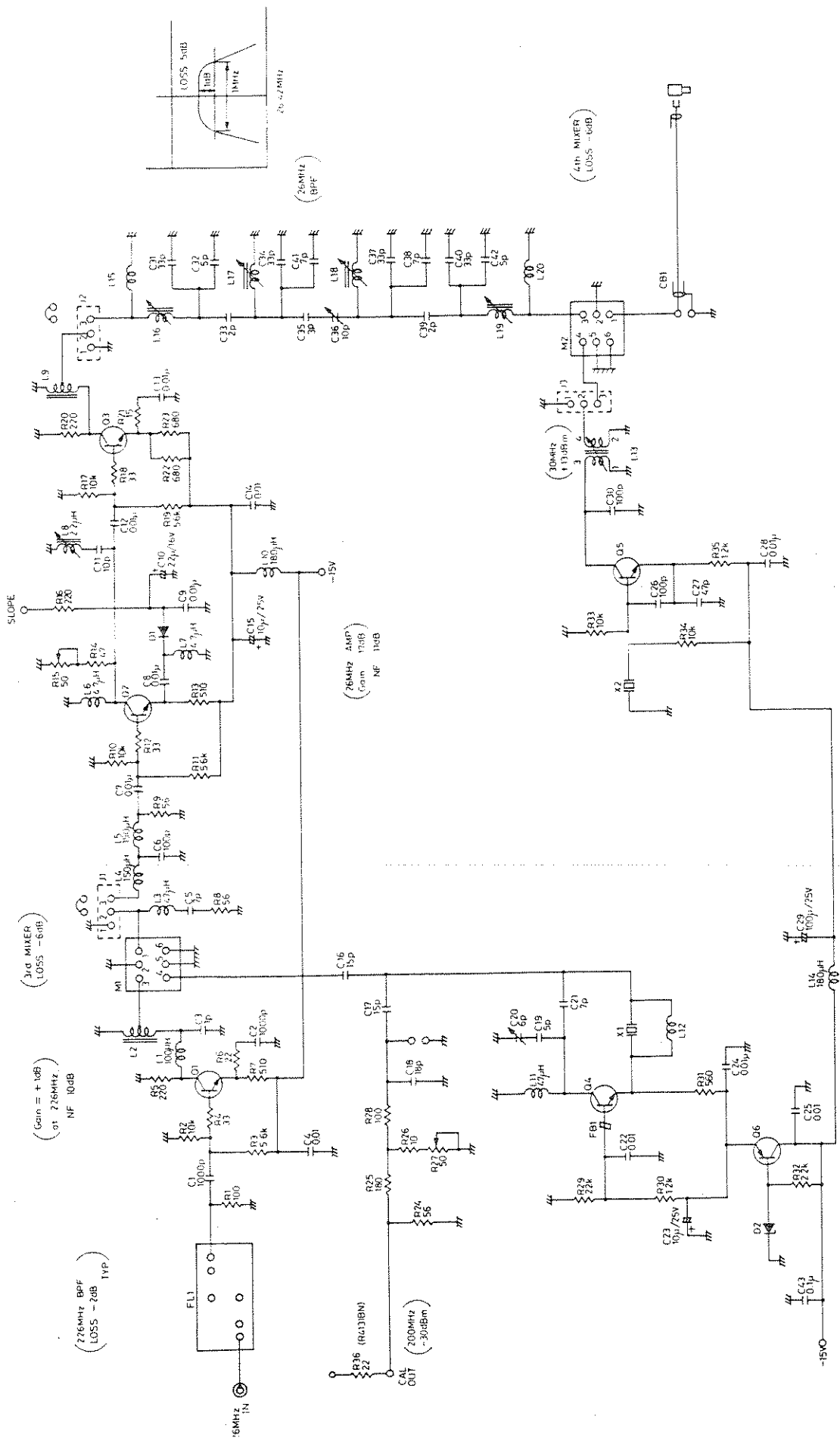

R4131 SERIES
RF 3rd
BLC-015118
 A - 69

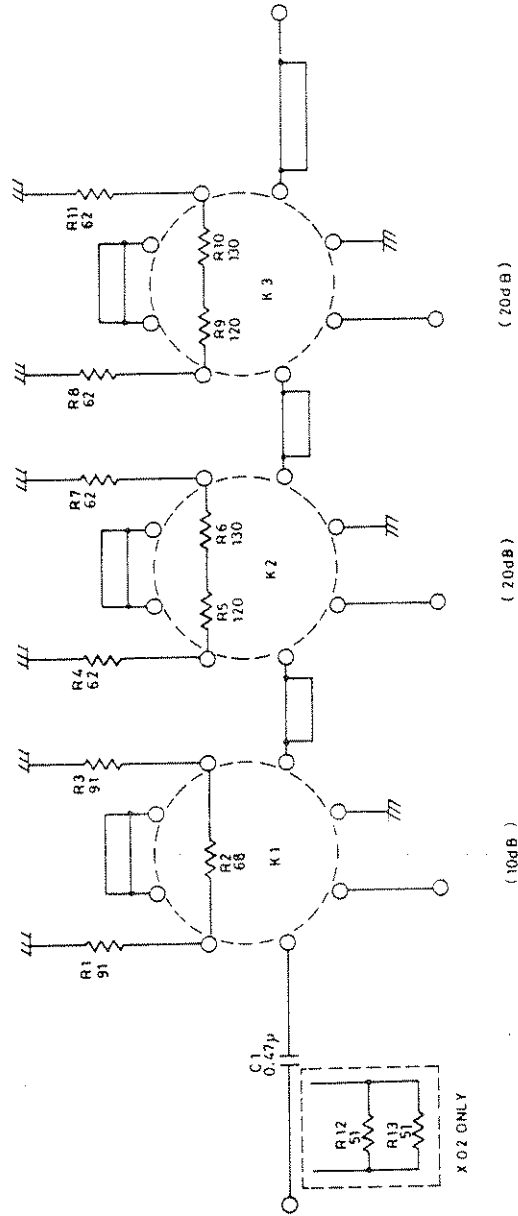

(20dB)

(20dB)

(10dB)

X 02 ONLY

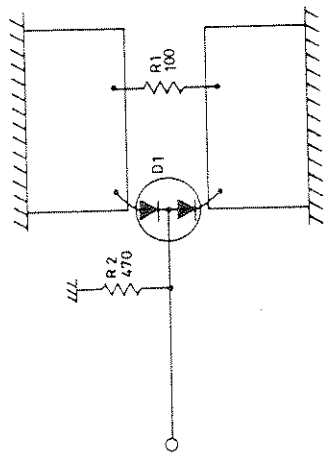

R4131 SERIES
RF 1st
BTB-015120
A - 71

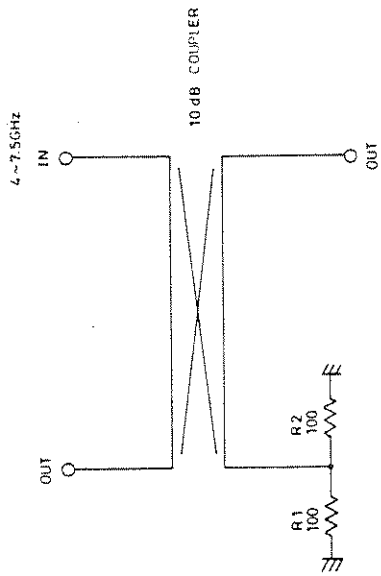

R4131 SERIES
COUPLER
BTB-015122
A - 72

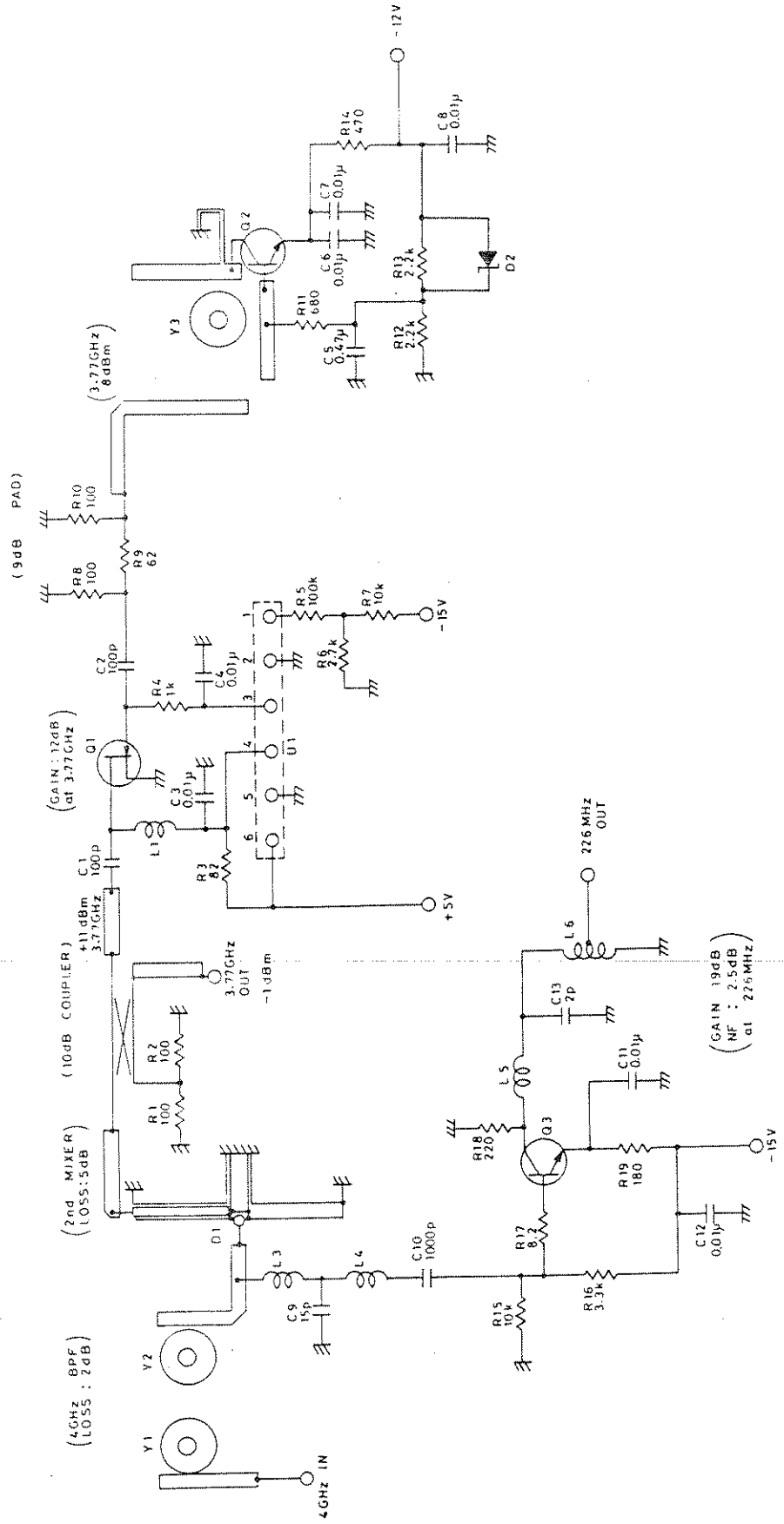

R4131A/C
 RF - 2nd
 BTC-015121
 A - 73

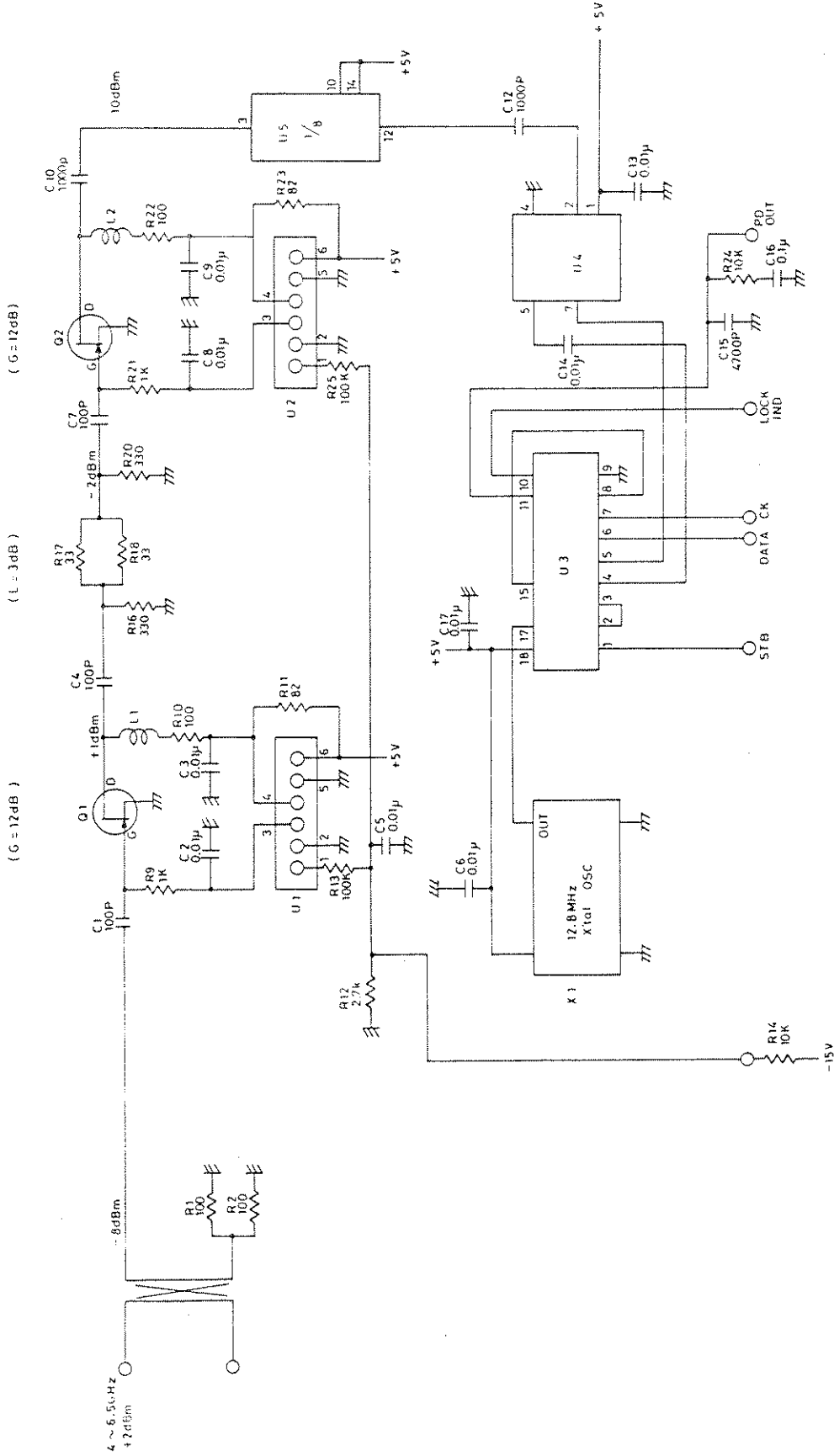

R4131B/BN/D/DN
 AFC
 BTB-015245
 A - 74*

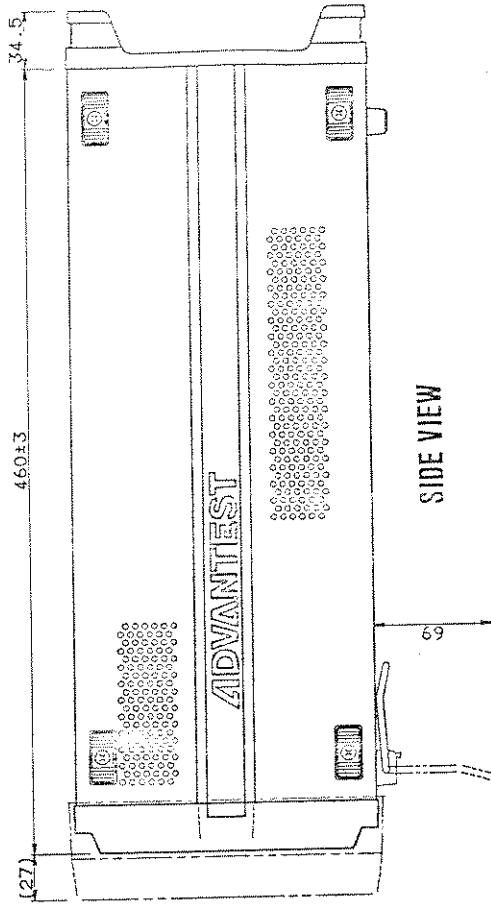

SIDE VIEW

Unit : mm

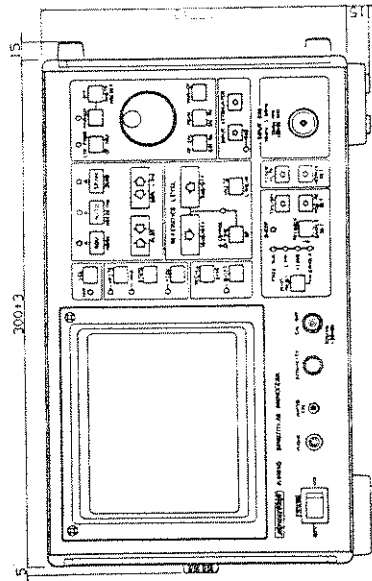

FRONT VIEW

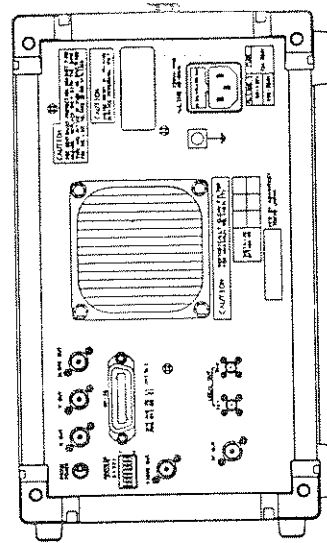

REAR VIEW

R4131

EXTERNAL VIEW

R4131EXT1-9402-C

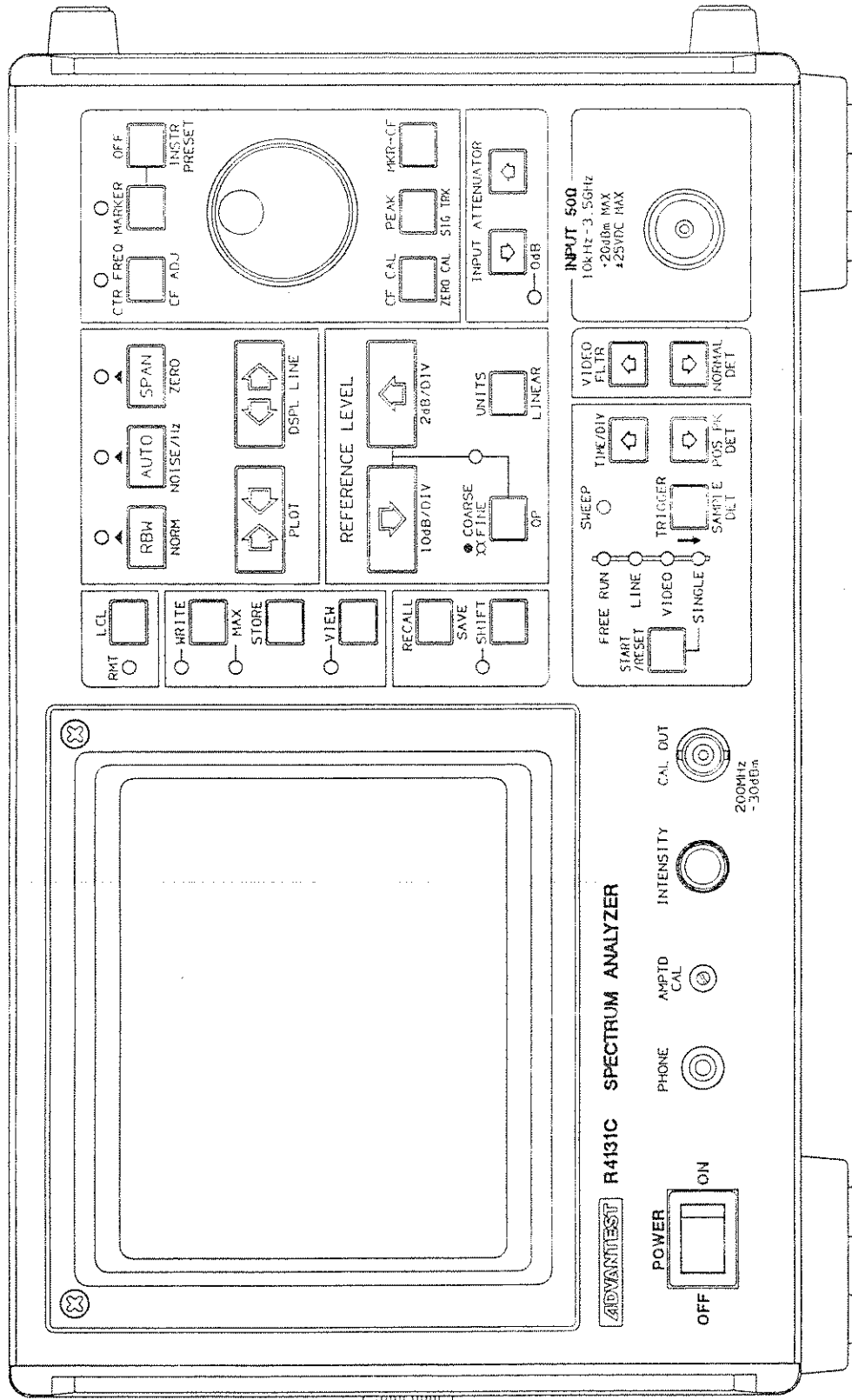

R4131C

FRONT VIEW

ADVANTEST R4131C SPECTRUM ANALYZER

POWER OFF ON

PHONE

AMPTD CAL

INTENSITY

CAL OUT

200MHz - 3000m

RMT LCL RBW NORM AUTO NOISE/Hz SPAN ZERO CTR FREQ MARKER OFF INSTR PRESET

WRITE MAX STORE VIEW RECALL SAVE SHIFT

PLOT DSPL LINE REFERENCE LEVEL 10dB/DIV 2dB/DIV UNITS LINEAR L LINEAR

COARSE FINE QP ZERO CAL PEAK MKR-CF ZHR CAL SIG TRK INPUT ATTENUATOR 0dB

SLEEP TRIGGER SAMP E POS PK DET DELT NORMAL DET

FREE RUN START/PRESET LINE VIDEO SINGLE

VIDEO FILTERS VIDEOS

INPUT 500
 10kHz - 3.5GHz
 +20dBm MAX
 +25VDC MAX

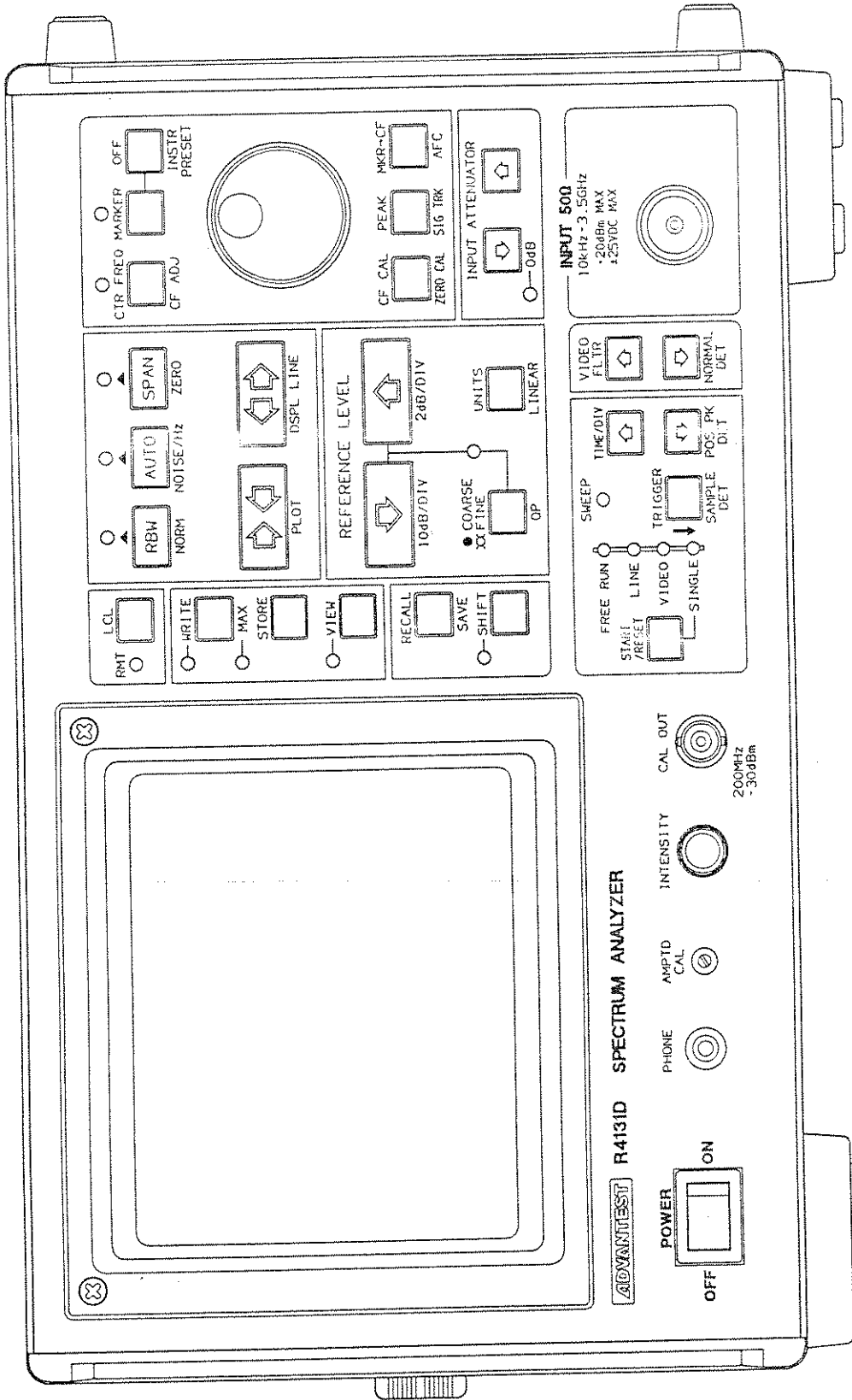

R4131D

FRONT VIEW

R4131EXT4-9402-B

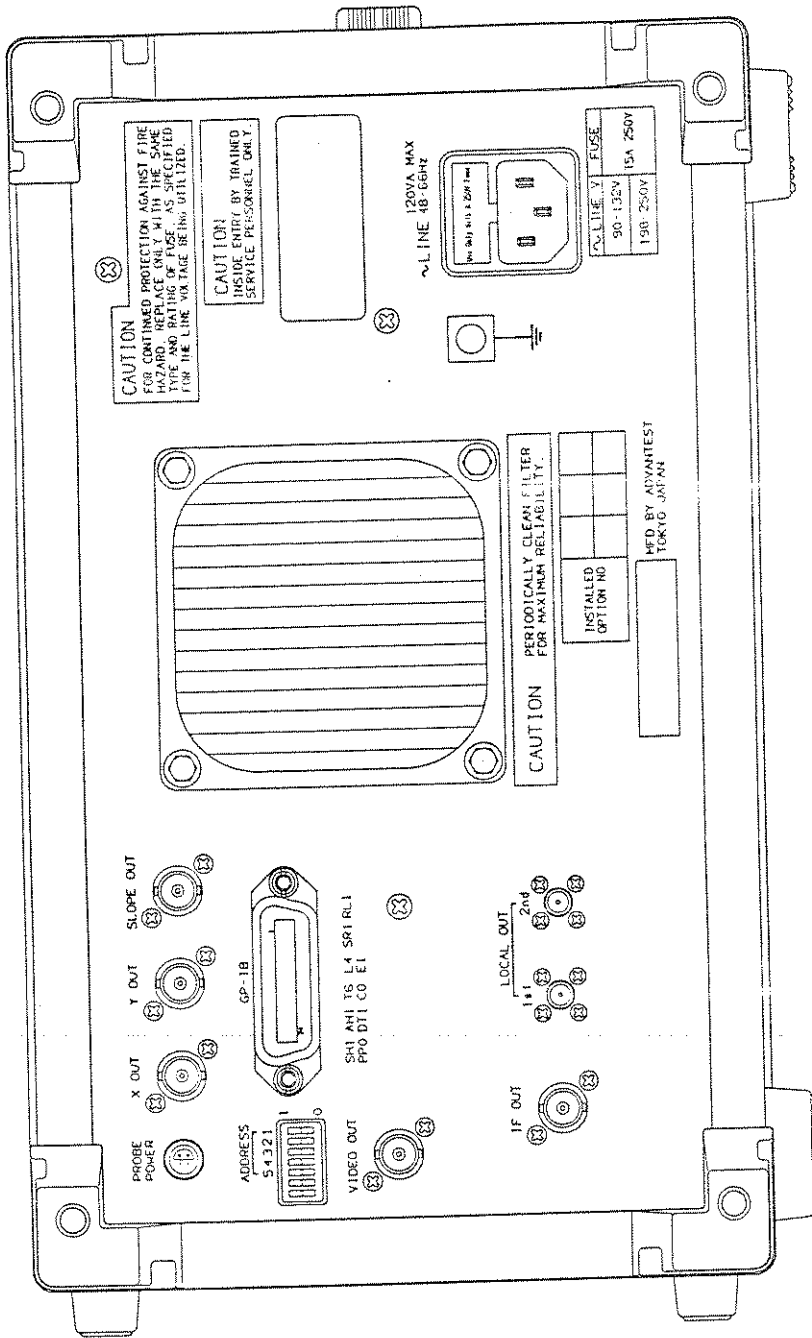

R4131

REAR VIEW

R4131EXT6-9402-C

ADVANTEST product is warranted against defects in material and workmanship for a period of one year from the date of delivery to original buyer.

LIMITATION OF WARRANTY

The foregoing warranty shall not apply to defects resulting from improper or inadequate maintenance by buyer, unauthorized modification or misuse, accident or abnormal conditions of operations.

No other warranty is expressed or implied. ADVANTEST specifically disclaims the implied warranties of merchantability and fitness for a particular purpose.

ADVANTEST shall not be liable for any special incidental or consequential damages, whether in contract, tort or otherwise.

Any and all warranties are revoked if the product is removed from the country in which it was originally purchased.

SERVICE

During the warranty period, ADVANTEST will, at its option, either repair or replace products which prove to be defective.

When trouble occurs, buyer should contact his local supplier or ADVANTEST giving full details of the problem and the model name and serial number.

For the products returned to ADVANTEST for warranty service, buyer shall prepay shipping and transportation charges to ADVANTEST and ADVANTEST shall pay shipping and transportation charges to return the product to buyer. However, buyer shall pay all charges, duties, and taxes incurred in his country for products returned from ADVANTEST.

CLAIM FOR DAMAGE IN SHIPMENT TO ORIGINAL BUYER

The product should be thoroughly inspected immediately upon original delivery to buyer. All material in the container should be checked against the enclosed packing list or the instruction manual alternatively. ADVANTEST will not be responsible for shortage unless notified immediately.

If the product is damaged in any way, a claim should be filed by the buyer with carrier immediately. (To obtain a quotation to repair shipment damage, contact ADVANTEST or the local supplier.) Final claim and negotiations with the carrier must be completed by buyer.

SALES & SUPPORT OFFICES

Advantest America, Inc.

300 Knightsbridge Parkway Suite 200, Lincolnshire,
IL 60069 U.S.A.

Phone (708)634-2552

Facsimile (708)634-2872

Advantest UK Limited

CI Tower, St. Georges Square, High Street,
New Malden Surrey, KT3 4HH The United Kingdom

Phone (081)336-1606

Facsimile (081)336-1657

Advantest (Singapore) Pte. Ltd.

150 Beach Road, #01-00

Gateway West Singapore 0718

Phone (65)299-4268

Facsimile (65)299-4226

Advantest Giga S.A.

5, Av du Quebec Z.A. de Courtaboeuf
B.P.203-91941 Les Ulis Cedex, France

Phone (331)6918-2500

Facsimile (331)6982-9224

ADVANTEST®
ADVANTEST CORPORATION

Shinjuku-NS Building, 4-1, Nishi-Shinjuku 2-chome, Shinjuku-ku, Tokyo 163-08, JAPAN
Phone: (03)3342-7500 Facsimile: (03)3342-7410 Telex: 232-4914 ADVAN J

ADVANTEST

1
2
3
4
5
6
7
8
9
10
11
12
13
14
15
16
17
18
19
20
21
22
23
24
25
26
27
28
29
30
31
32
33
34
35
36
37
38
39
40
41
42
43
44
45
46
47
48
49
50
51
52
53
54
55
56
57
58
59
60
61
62
63
64
65
66
67
68
69
70
71
72
73
74
75
76
77
78
79
80
81
82
83
84
85
86
87
88
89
90
91
92
93
94
95
96
97
98
99
100